

MINIATURE RIBBON

STRAIGHT PCB TAIL

IDC FLAT CABLE

SOLDER TERMINALS

RIGHT ANGLE PCB MOUNT

MR SERIES

MR SERIES

Adam Tech MR Series Miniature Ribbon connectors come in a variety of terminations including Solder Terminals, Straight PCB Tails, Right Angle PCB mount, Flat Cable IDC and Straddle Mount Card Edge. These connectors with their high pressure, flat wiping contacts are a very popular widely used interface especially in telecommunication applications. Offered in 14, 24, 36 and 50 positions they are a good choice for high reliability positive latching connector applications. They combine an extremely reliable contact design with the popular, polarized D face. Adam Tech connectors are manufactured with precision stamped contacts and offer a wide selection of mating and mounting options.

FEATURES:

Available in many termination styles
High pressure blade contacts
Industry standard compatibility
Durable metal shell design
Variety of Mating and mounting options

MATING CONNECTORS:

Adam Tech Miniature Ribbon connectors and all industry standard miniature ribbon connectors.

SPECIFICATIONS:

Material:

Standard insulator: PBT, Glass filled, rated UL94V-0
Optional Hi-Temp insulator: Nylon 6T, rated UL94V-0
Insulator Color: Blue (Black optional)
Contacts: Phosphor Bronze
Shell: Steel, nickel plated

Contact Plating:

Gold flash over Nickel underplate on mating area, Tin over Copper underplate on tails

Electrical:

Operating Voltage: 250V AC
Current Rating: 1 Amp max.
Contact Resistance: 35 mΩ max.
Insulation Resistance: 1000 MΩ min.
Dielectric Withstanding Voltage: 1000V AC for 1 minute

Mechanical:

Insertion force: 12 oz max.
Withdrawal force: 4.8 oz min.

Temperature Rating:

Operating Temperature: -55°C to +105°C
Soldering process temperature:
Standard insulator: 235°C
Hi-Temp insulator: 260°C

PACKAGING:

Anti-ESD plastic trays

APPROVALS AND CERTIFICATIONS:

UL Recognized & CSA Certified, File no. E224053

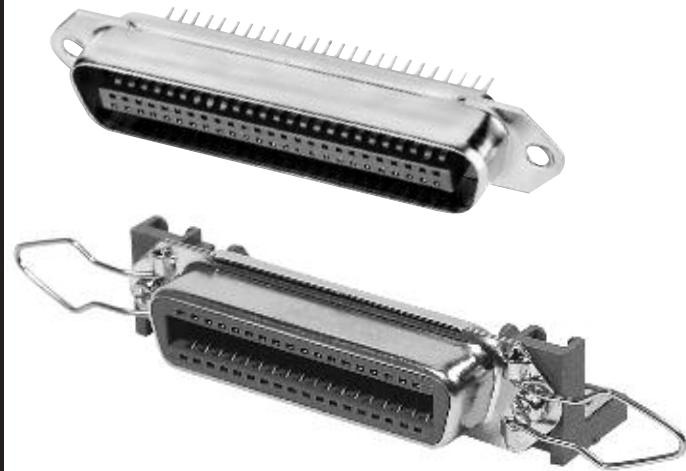

ORDERING INFORMATION

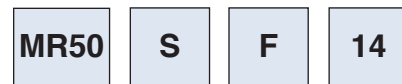

SHELL SIZE & POSITIONS

MR14 = 14 Contacts
MR24 = 24 Contacts
MR36 = 36 Contacts
MR50 = 50 Contacts

MOUNTING

1 = Spring latches with .120" diameter mounting holes (socket only)
14 = Spring latches with #4-40 clinch nuts in mounting holes (socket only)
2 = Notch Ears (plug only)
3 = .120" diameter mounting holes only
34 = #4-40 threaded clinch nuts in mounting holes w/o spring latches

CONTACT TYPE

P = Plug
S = Socket

TERMINATION TYPE

A = Solder Terminals
C = Straight PCB Tail
D = Right Angle PCB Mount
E = IDC, All plastic shell
F = IDC, Metal Shell
G = Straddle Mount Tails

OPTIONS:

Add designator(s) to end of part number
30 = 30 μin gold plating in contact area
BK = Black color insulator
F = Forked boardlocks
HT = Hi-Temp insulator for Hi-Temp soldering processes up to 260°C
LI = Spring Latches Installed

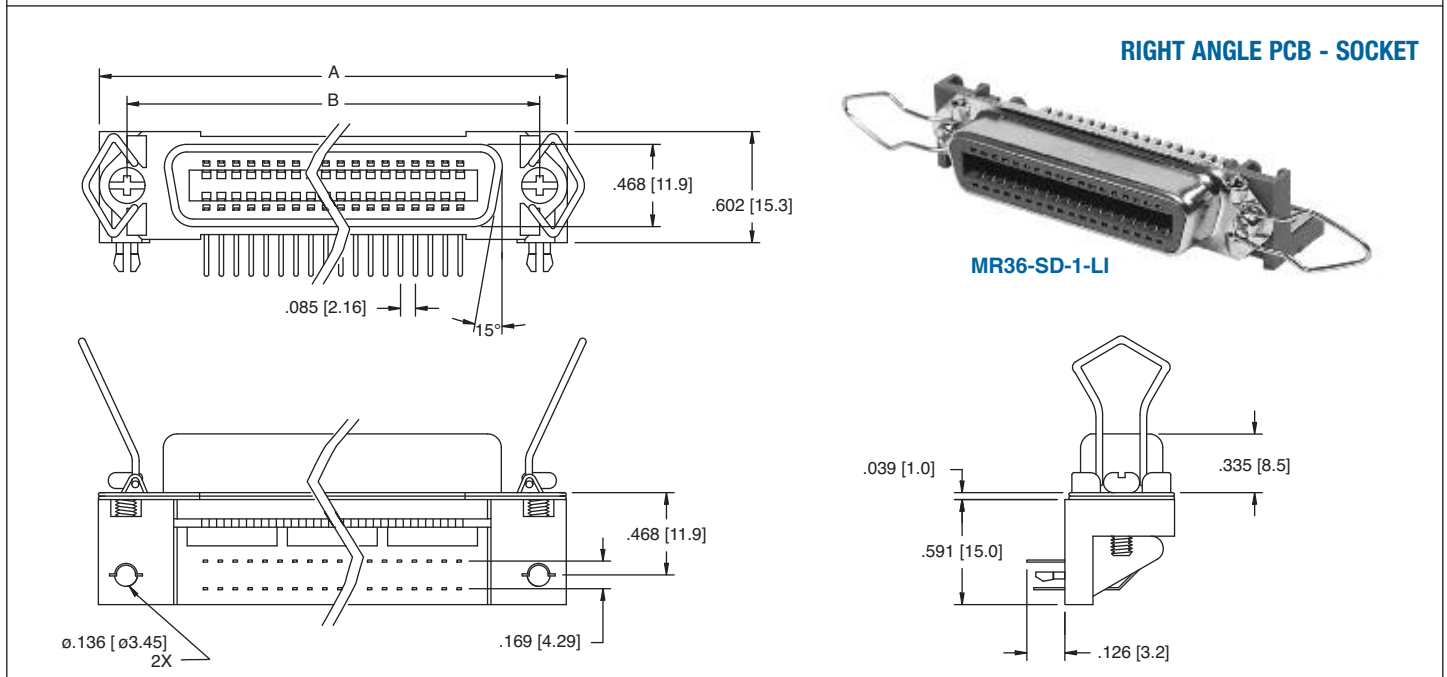
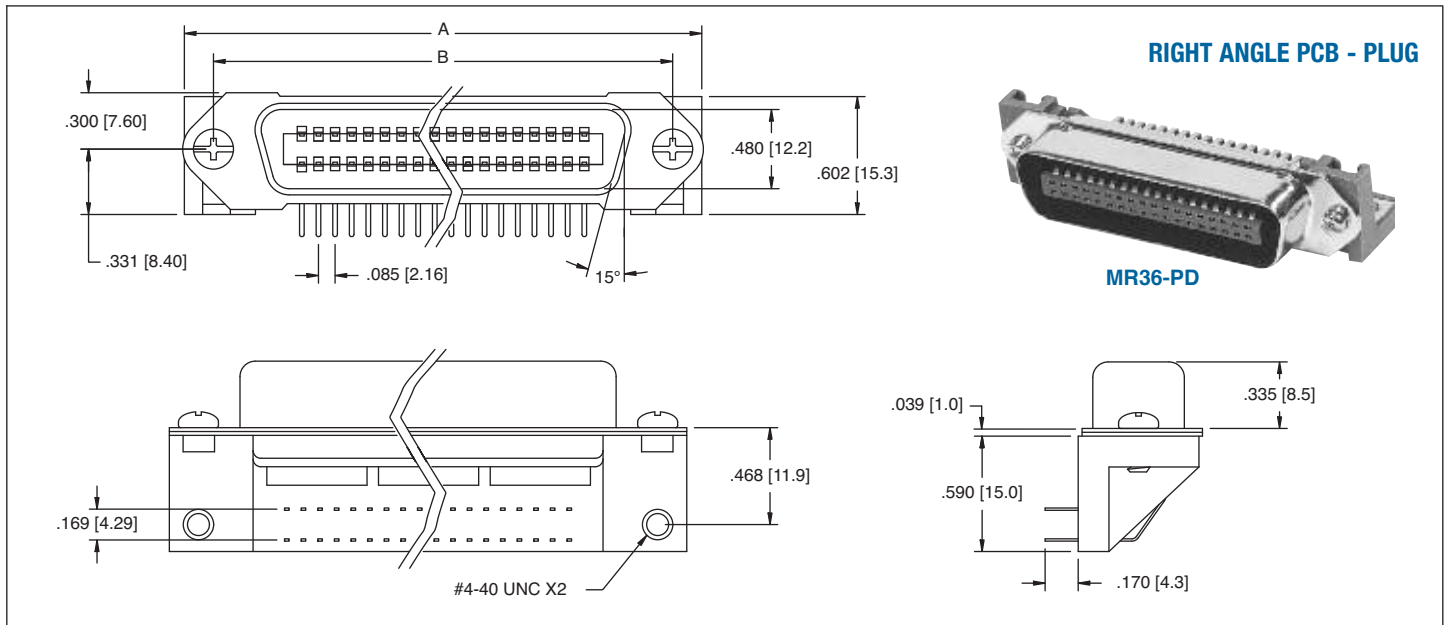

Ordering Information pg. 117

Unit: Inch [mm]

PART NO.	Dimensions	
	A	B
MR14-SD MR14-PD	1.750 [44.45]	1.417 [35.99]
MR24-SD MR24-PD	2.175 [55.25]	1.842 [46.79]
MR36-SD MR36-PD	2.685 [68.20]	2.352 [59.74]
MR50-SD MR50-PD	3.280 [83.31]	2.947 [74.85]

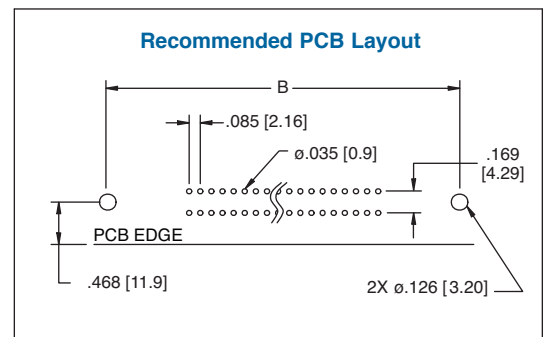

Ordering Information pg. 117

IDC FLAT CABLE - PLUG

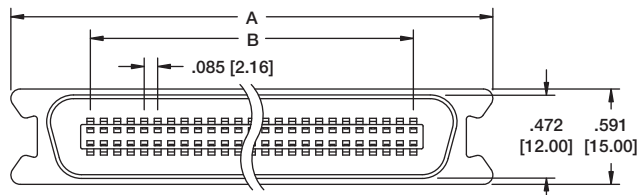

MR36-PF-2

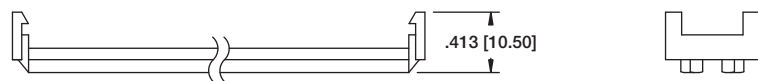
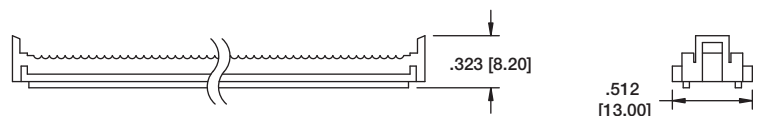
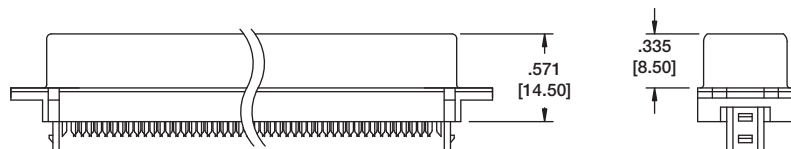

Unit: Inch [mm]

PART NO.	Dimensions	
	A	B
MR14-SF MR14-PF	1.750 [44.45]	1.417 [35.99]
MR24-SF MR24-PF	2.175 [55.25]	1.842 [46.79]
MR36-SF MR36-PF	2.685 [68.20]	2.352 [59.74]
MR50-SF MR50-PF	3.280 [83.31]	2.947 [74.85]

IDC FLAT CABLE - SOCKET

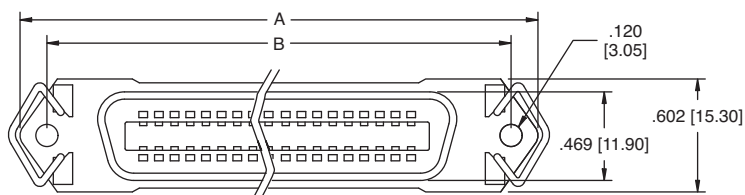

MR36-SF-1-LI

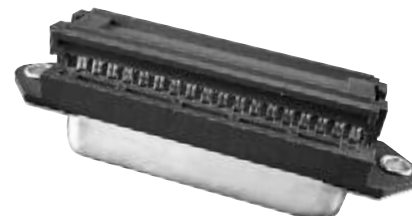
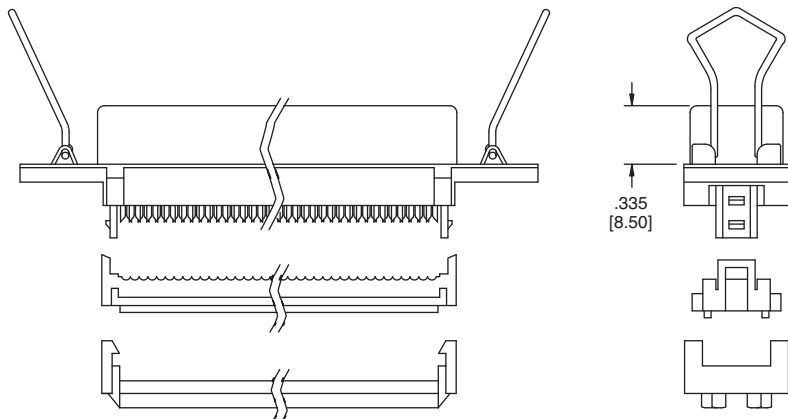

MR36-SF-3

Ordering Information pg. 117

STRAIGHT PCB TAIL PLUG

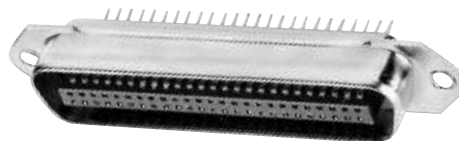
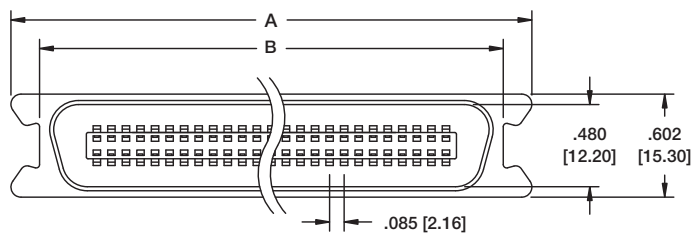

MR50-PC-3



MR36-PC-2

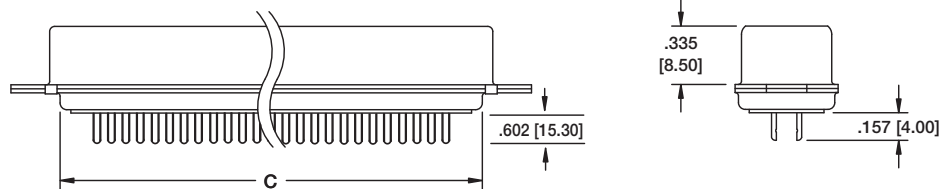

STRAIGHT PCB TAIL SOCKET

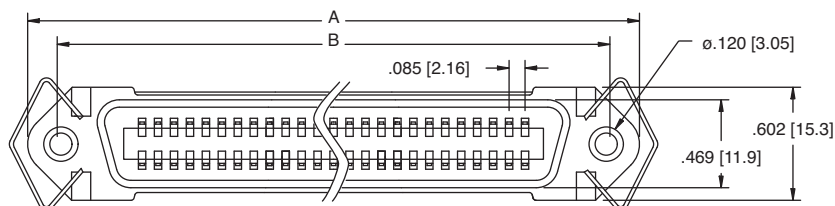

MR50-SC-1-LI

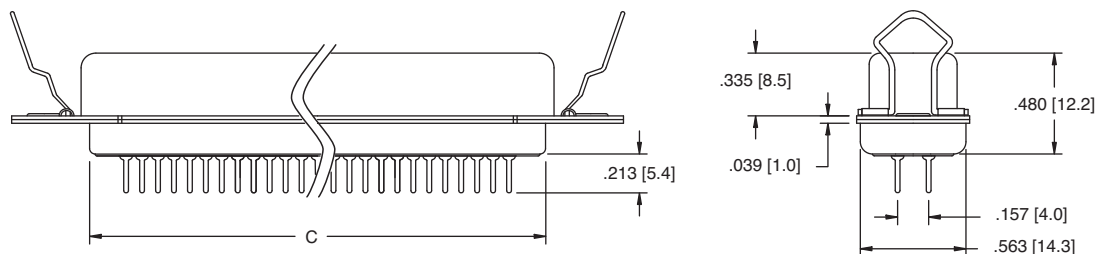

Unit: Inch [mm]

PART NO.	Dimensions	
	A	B
MR14-SC MR14-PC	1.750 [44.45]	1.417 [35.99]
MR24-SC MR24-PC	2.175 [55.25]	1.842 [46.79]
MR36-SC MR36-PC	2.685 [68.20]	2.352 [59.74]
MR50-SC MR50-PC	3.280 [83.31]	2.947 [74.85]

Recommended PCB Layout

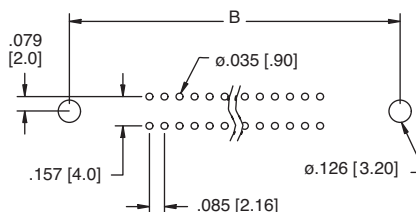

Ordering Information pg. 117

SOLDER TERMINALS - PLUG

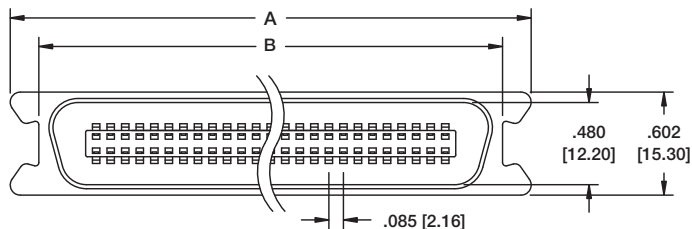

MR36-PA-2

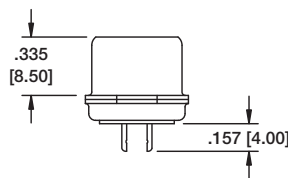
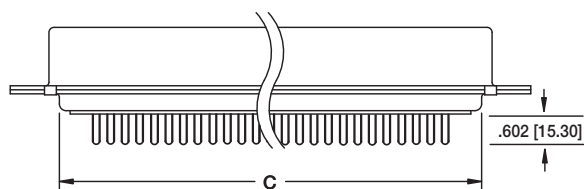

SOLDER TERMINALS - SOCKET

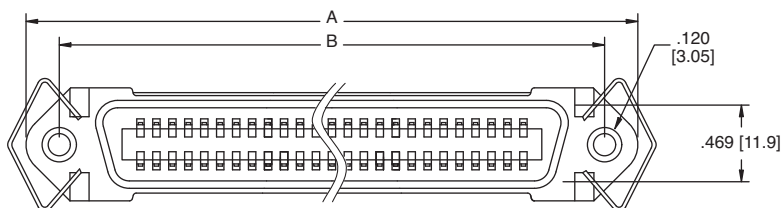

MR36-SA-1-LI

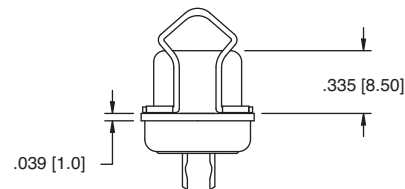
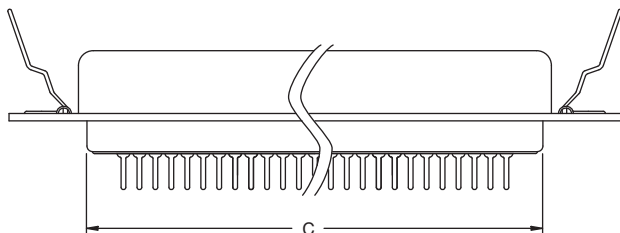

Unit: Inch [mm]

PART NO.	Dimensions	
	A	B
MR14-SA MR14-PA	1.750 [44.45]	1.417 [35.99]
MR24-SA MR24-PA	2.175 [55.25]	1.842 [46.79]
MR36-SA MR36-PA	2.685 [68.20]	2.352 [59.74]
MR50-SA MR50-PA	3.280 [83.31]	2.947 [74.85]