

INTRODUCTION:

Adam Tech IEC & Mini IEC Series AC Inlets and Outlets are primary power receptacles designed, manufactured, tested and approved to UL, CSA, VDE and other applicable international specifications including IEC-60320 and CEE-22. Adam Tech offers a wide variety of body styles, shapes and orientations to accommodate most class I & II applications with two or three blade contacts in both IEC and Mini-IEC configurations. Mounting choices include screw holes and snap-in versions and four termination styles. Options of ganged ports or receptacle with integral fuse holder are also available.

FEATURES:

IEC & Mini-IEC types
IEC-60320, CEE-22 Compliant
UL, CSA and VDE approved
Multitude of Body Styles
Choice of terminations
Option of Integral Fuse Holder

MATING CONNECTORS:

Adam Tech PC series power cords and all standard international IEC 60320 power supply cords.

SPECIFICATIONS:

Material:

Insulator: Polycarbonate or Nylon 66, glass filled, rated UL94V-0
Insulator Color: Black
Contacts: Phosphor Bronze or Brass

Plating:

Nickel over copper underplate. (Solder terminals: Tin over copper underplate)

Electrical:

Operating Voltage: 250V AC
Current Rating: IEC - UL & CSA: 15 Amps Max,
VDE: 10 Amps Max.
Mini IEC - UL, CSA & VDE 2.5 Amps Max.

Insulation Resistance: 100 MΩ Min. @ 500V DC
Dielectric Withstanding Voltage: 2000V AC for 1 Minute

Temperature Rating:

Operation Temperature: -25°C ~ +70°C

PACKAGING:

Anti-ESD plastic trays

SAFETY AGENCY APPROVALS:

UL Recognized File Nos. E224049, E224050, E224051, E224052
CSA Certified File No. 226373



DB12



ORDERING INFORMATION

IEC	A	1	150
SERIES INDICATOR IEC = International inlet/outlet	TERMINALS		PANEL THICKNESS (for body styles C, D & J only) Blank = Universal Snap Panel
	1 = .187" Quick-connect terminals	2 = .250" Quick-connect terminals	080 = 0.8mm Panel
	3 = Solder terminals .157" [4.0mm]	4 = Right Angle PCB mount	120 = 1.2mm Panel
	5 = Solder Terminals .098" [2.5mm]		150 = 1.5mm Panel
			200 = 2.0mm Panel
			300 = 3.0mm Panel

BODY STYLE

- A = Male Inlet, Screw-on panel mount
- B = Female Outlet, Screw-on panel mount
- C = Male Inlet, Snap-in panel mount
- D = Female Outlet, Snap-in panel mount
- E = Male Inlet, Right Angle PCB board mount with mounting flange (Specify EW, EX, EY or EZ)
- F = Male Inlet, Screw on panel mount with 5 x 20mm fuse holder
- G = Male Inlet, Snap-in panel mount with 5 x 20mm fuse holder
- HS = Inlet/Outlet, snap-in panel mount
- HR = Inlet/outlet, snap-in panel mount, right angle PCB mount
- J = Male inlet, right angle PCB & tail with snap-in panel mounting
- NA = Mini-IEC right angle, snap-in
- NB = Mini-IEC right angle, slide-in
- NB-A = Mini-IEC right angle, slide-in with pegs
- NC = Mini-IEC right angle, with flush flange
- NC-A = Mini-IEC right angle, with extended face
- ND = Mini-IEC right angle, with enclosed body
- NF = Mini-IEC right angle, polarized with flange
- NH = Mini-IEC right angle, with ground pin
- NH-A = Mini-IEC right angle, flange mount with ground pin
- GS = Fused inlet with switch snap in panel mount
- FS = Fused inlet with switch screw on panel mount

OPTIONS:

- K = Keyed for 120° C (Body Styles A, C, E & J)
- M = Female outlet, 20 AMP, Flanged
- N = Male inlet, 20 AMP, Snap-In

**IEC-A
SCREW ON
PANEL MOUNT**

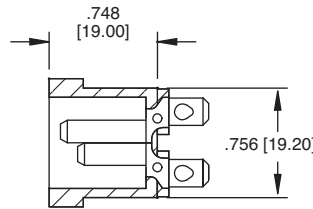
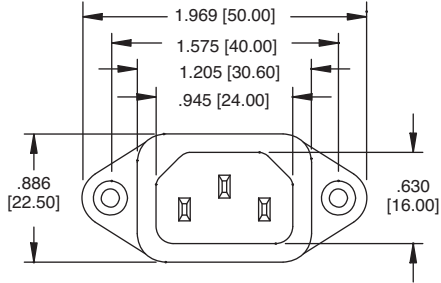

IEC-A-1

1.075 [27.30] Front Mounting
1.212 [30.80] Rear Mounting

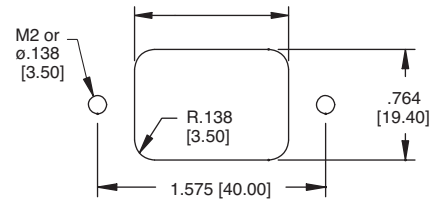
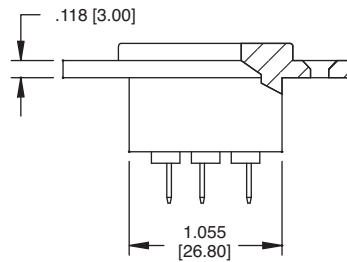

TERMINAL OPTIONS			
1	2	3	5
.187 Q.C.	.250 Q.C.	.157 Solder	.098 Solder

**IEC-A
SCREW ON PANEL
RIGHT ANGLE PCB MOUNT**

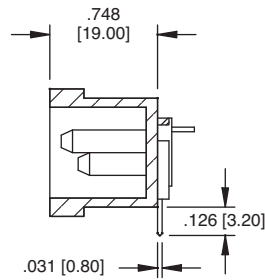
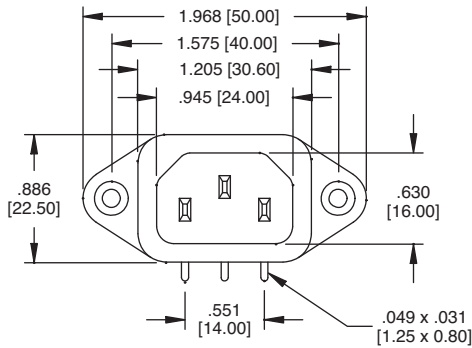

IEC-A-4

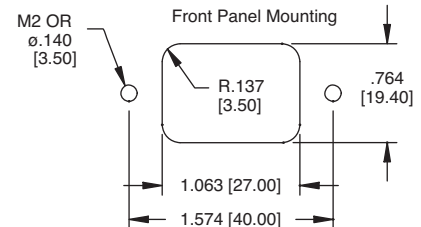
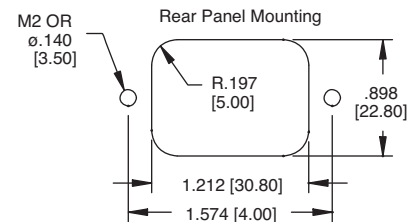
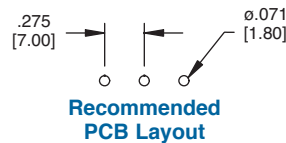
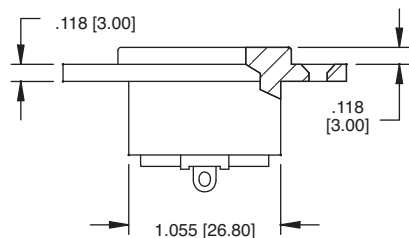

IEC-C UNIVERSAL PANEL SNAP

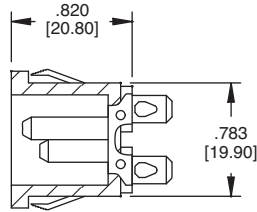
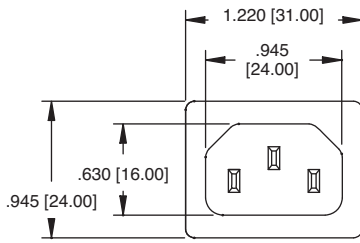

IEC-C-1

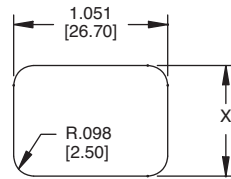
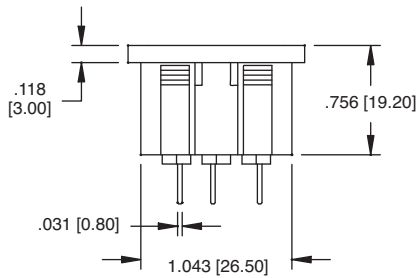

Recommended Panel Thickness: 0.8mm - 3.0mm

PANEL THICKNESS	DIM X
.031-.039 [0.8-1.0]	.780 [19.8]
.039-.059 [1.0-1.5]	.784 [19.9]
.079-.119 [2.0-3.0]	.788 [20.0]

TERMINAL OPTIONS			
1	2	3	5
.187 Q.C.	.250 Q.C.	.157 Solder	.098 Solder

IEC-C DEDICATED PANEL SNAP

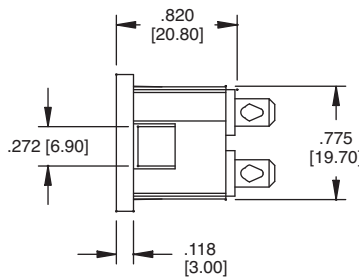
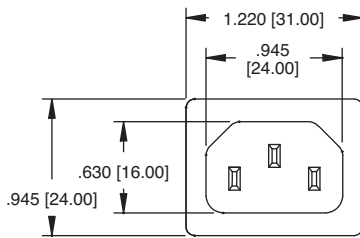

IEC-C-1-150

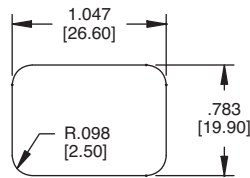
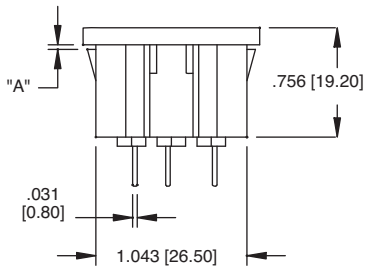

Recommended Panel Cut-Out

PANEL THICKNESS	PART NUMBER	DIM "A"
0.8mm	IEC-C-X-080	.031 [0.80]
1.5mm	IEC-C-X-150	.059 [1.50]
3.0mm	IEC-C-X-300	.118 [3.00]
4.0mm	IEC-C-X-400	.157 [4.00]

Replace X with terminal option below

TERMINAL OPTIONS			
1	2	3	5
.187 Q.C.	.250 Q.C.	.157 Solder	.098 Solder

**IEC-J
UNIVERSAL PANEL SNAP
RIGHT ANGLE PCB MOUNT**

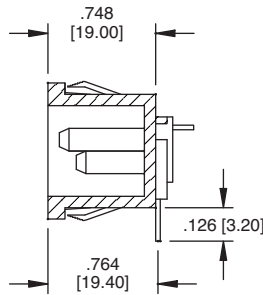
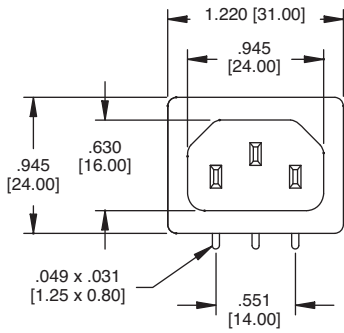

IEC-J-4

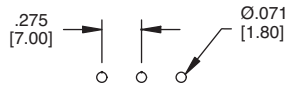
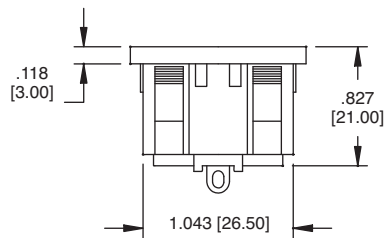

**Recommended PCB
Layout**

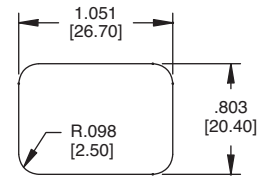

**Recommended Panel
Thickness: 0.80mm - 3.0mm**

**IEC-J
DEDICATED PANEL SNAP
RIGHT ANGLE PCB MOUNT**

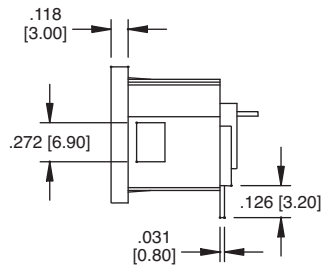
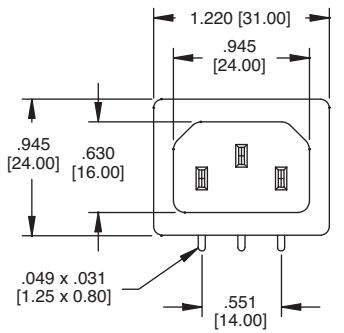

IEC-J-4-150

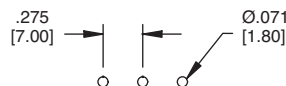
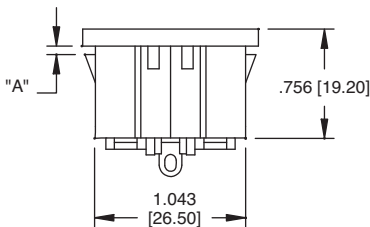

**Recommended PCB
Layout**

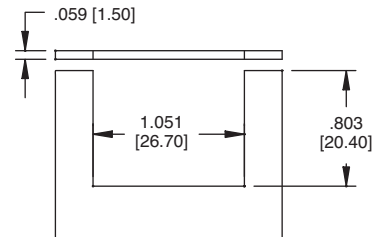

Recommended Panel Cut-Out

PANEL THICKNESS	PART NUMBER	DIM "A"
0.8mm	IEC-J-4-120	.047 [1.20]
1.5mm	IEC-J-4-150	.059 [1.50]
3.0mm	IEC-J-4-200	.079 [2.00]
4.0mm	IEC-J-4-300	.118 [3.00]

IEC-E FLANGED RIGHT ANGLE PCB MOUNT

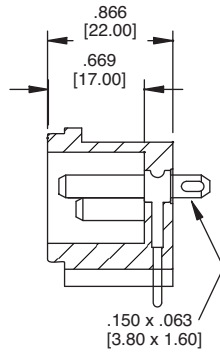
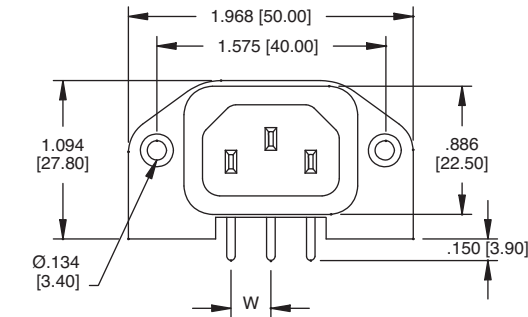

IEC-EW-4

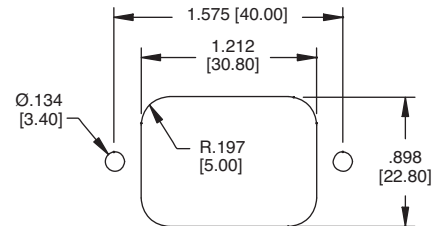

Recommended Panel Cut-Out

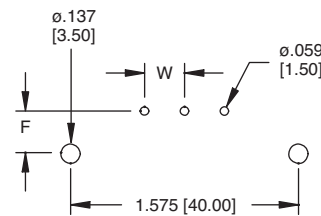
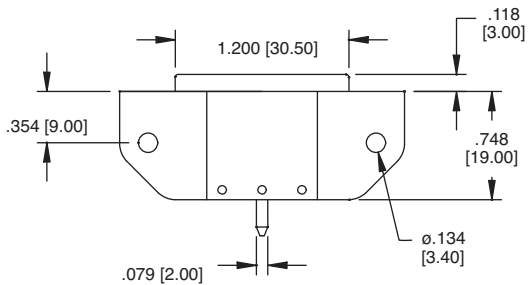

Recommended PCB Layout

DIMENSIONAL		
PART NO.	F	W
IEC-EW	.287 [7.30]	.276 [7.00]
IEC-EX	.287 [7.30]	.358 [9.10]
IEC-EY	.382 [9.70]	.276 [7.00]
IEC-EZ	.382 [9.70]	.358 [9.10]

IEC-B FLANGED SCREW ON PANEL MOUNT

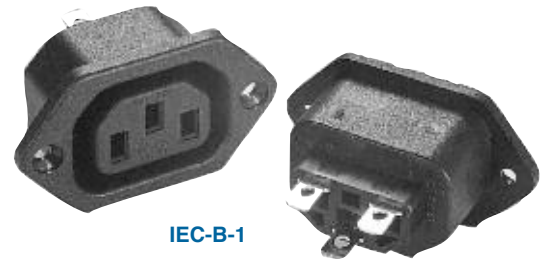
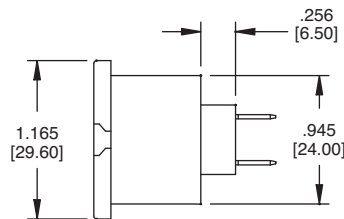
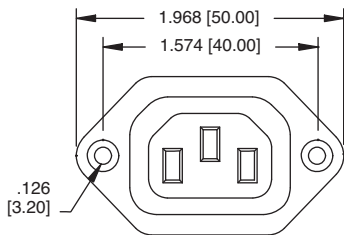

IEC-B-1

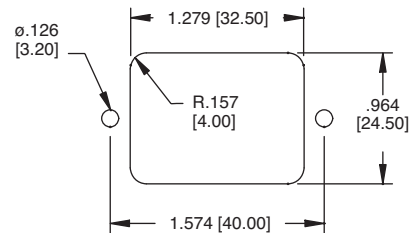

Recommended Panel Cut-Out

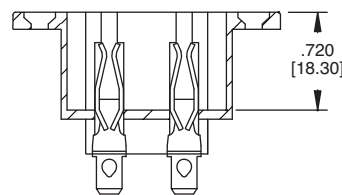
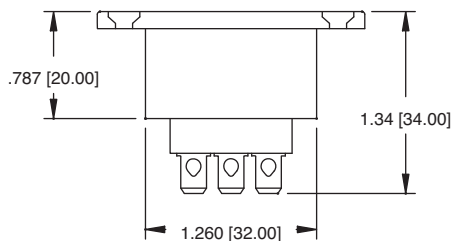

Cross Section

TERMINAL OPTIONS		
1	2	3
.187 Q.C.	.250 Q.C.	.157 Solder

**IEC-D
UNIVERSAL
PANEL SNAP**

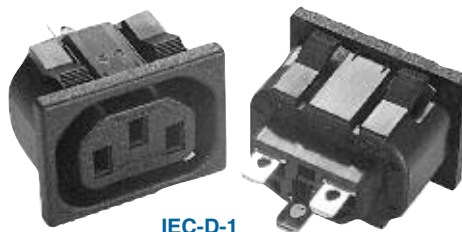
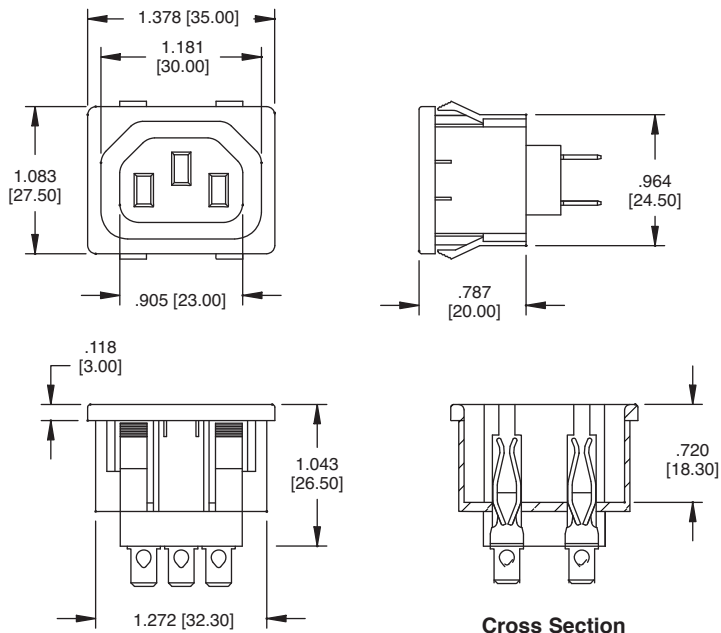

IEC-D-1

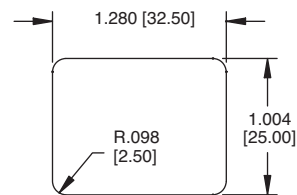

**Recommended Panel Thickness:
0.8mm - 3.0mm**

TERMINAL OPTIONS		
1	2	3
.187 Q.C.	.250 Q.C.	.157 Solder

**IEC-F
FUSED, SCREW ON
PANEL MOUNT**

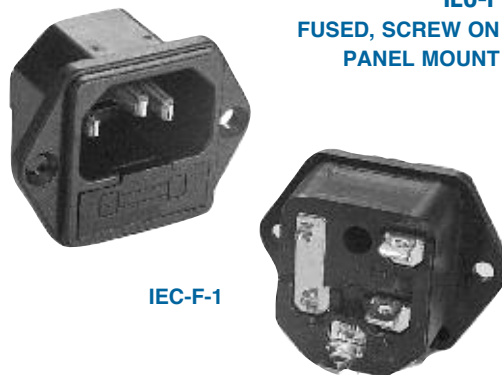
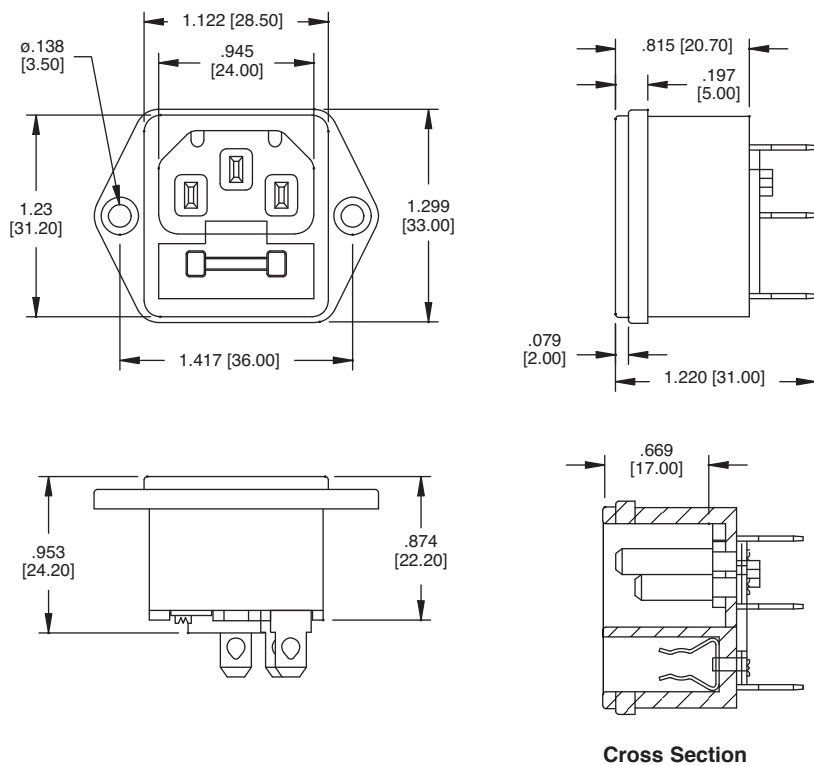

IEC-F-1

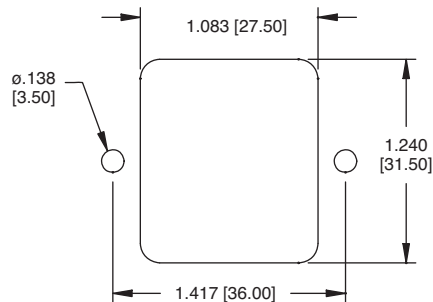

Recommended Panel Cut-Out

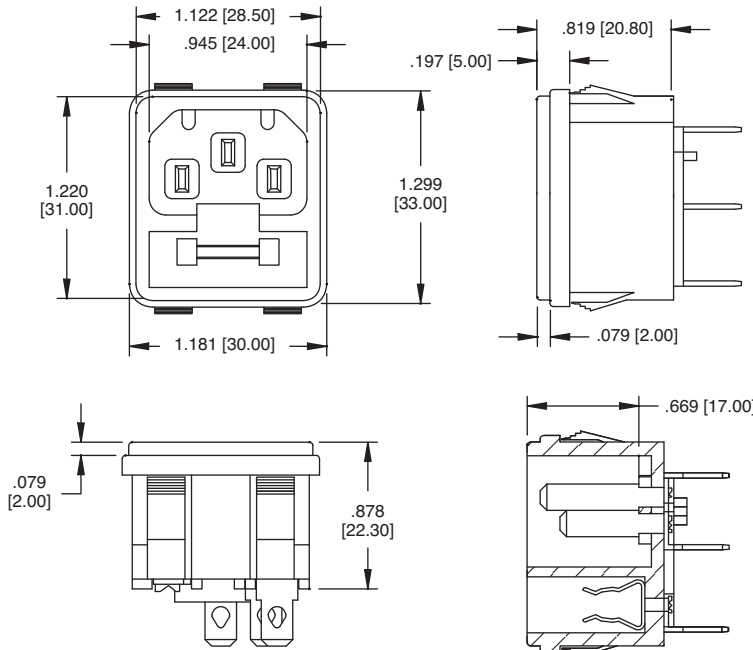

PANEL THICKNESS	DIM X
.031-.071 [0.8-1.8]	1.240 [31.50]
.075-.126 [1.9-3.2]	1.248 [31.70]

Cross Section

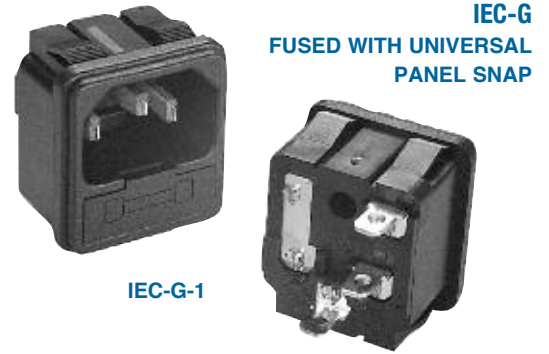

IEC-G-1

IEC-G
FUSED WITH UNIVERSAL
PANEL SNAP

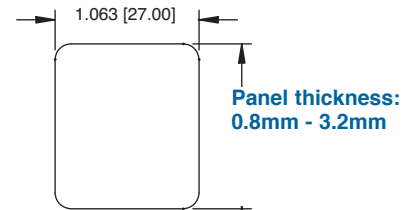

TERMINAL OPTIONS		
1	2	3
.187 Q.C.	.250 Q.C.	.157 Solder

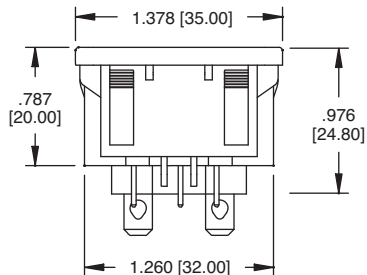
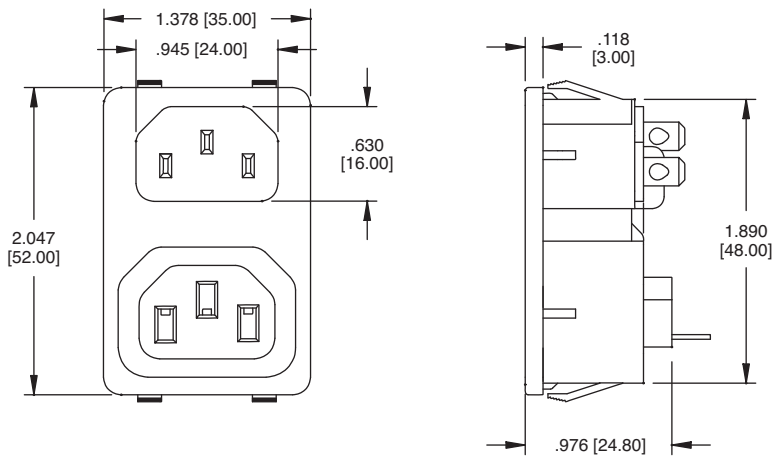

Recommended Panel Cut-Out

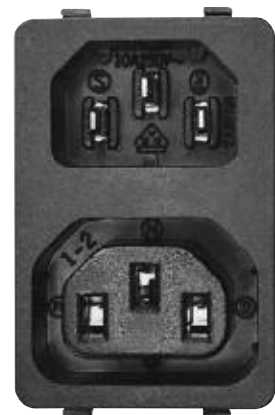

IEC-HS-1

IEC-HS
FUSED INLET & OUTLET
WITH UNIVERSAL
PANEL SNAP

IEC-GS-1

FUSED INLET WITH SWITCH,
SNAP IN PANEL MOUNT

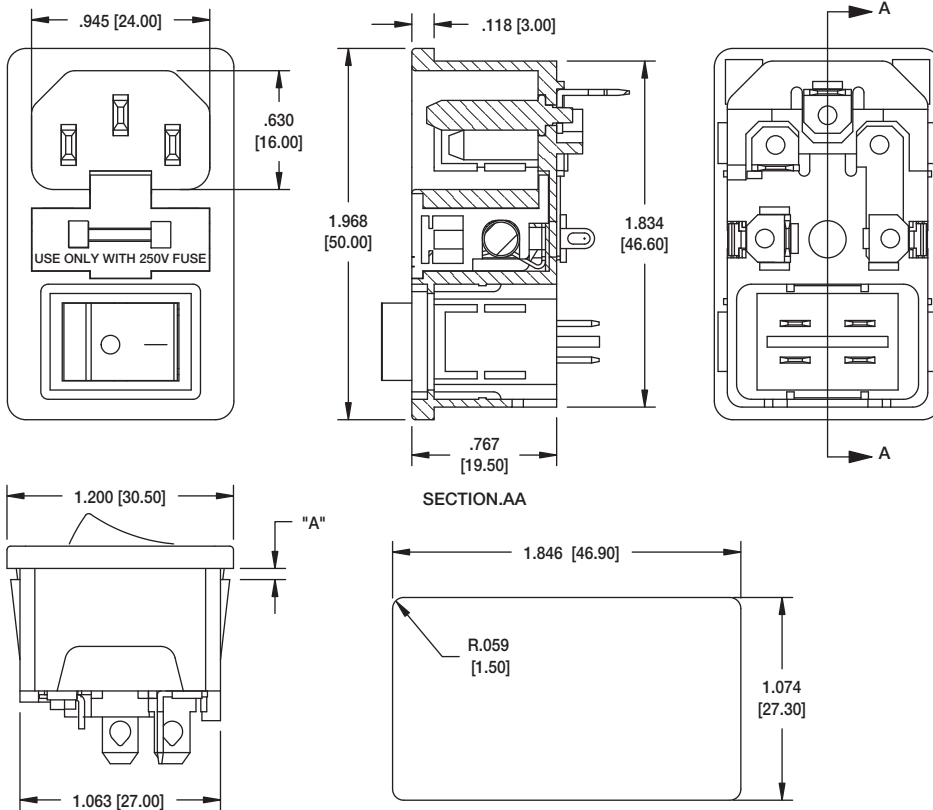

PART NUMBER	DIM "A"
IEC-GS-1-100	.039 [1.00]
IEC-GS-1-150	.059 [1.50]
IEC-GS-1-200	.079 [2.00]



IEC-GS-1-100

Recommended Panel Cut-Out

IEC-FS-1

FUSED INLET WITH SWITCH,
SWITCH, SCREW ON
PANEL MOUNT

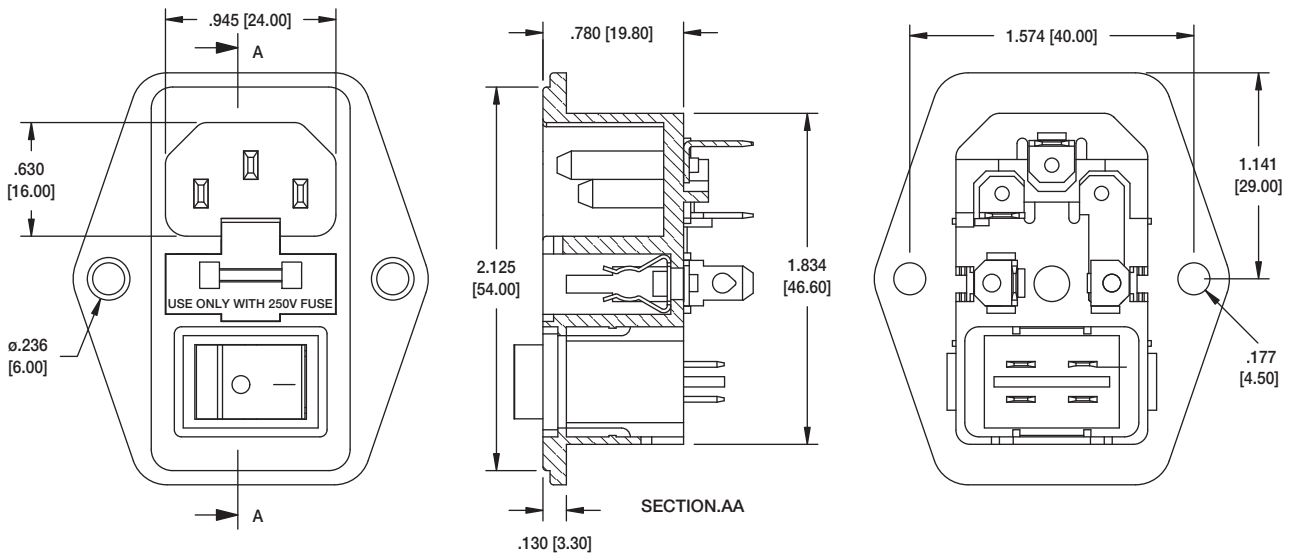

IEC-D-S
STACKED OUTLETS WITH
DEDICATED PANEL SNAPS

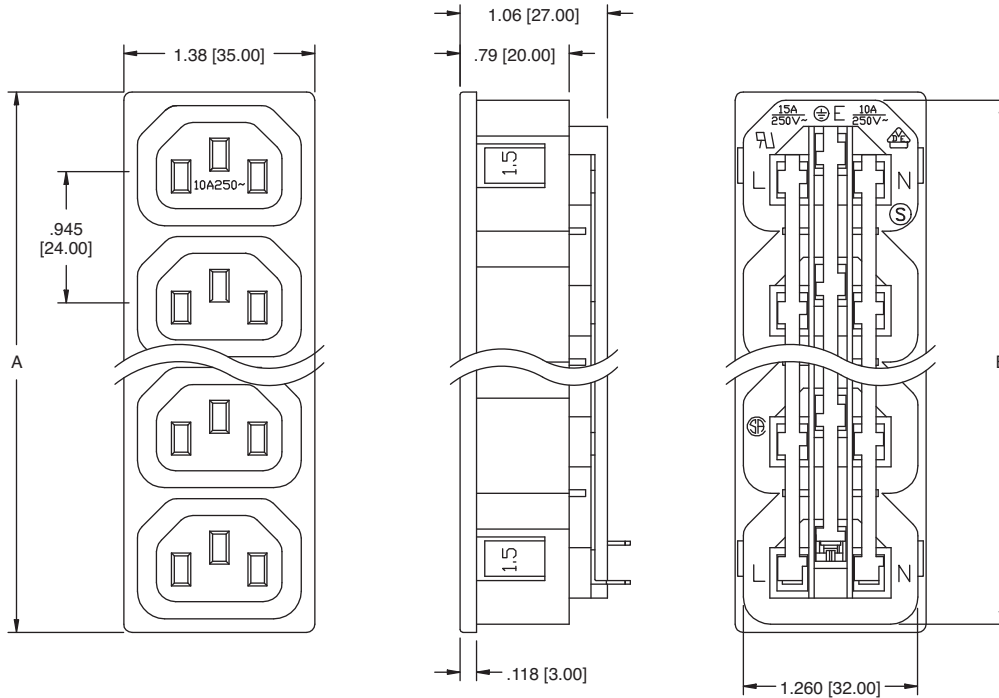

2 THRU 7 PORTS AVAILABLE

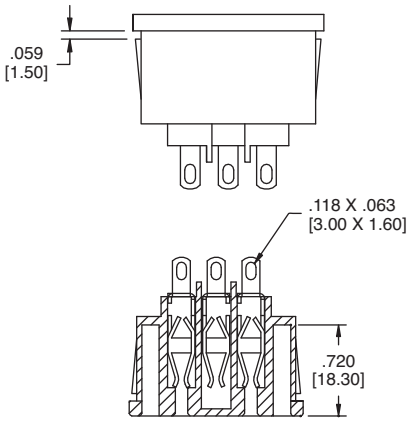

Cross Section

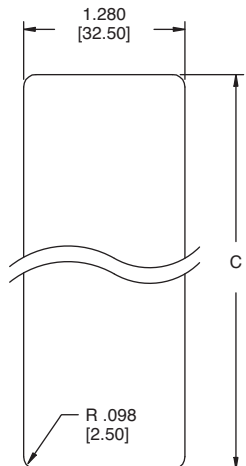

Recommended Panel Cut-Out



IEC-D-S4-150

DIMENSIONS				
PART NUMBER	PORTS	A	B	C
IEC-D-S2-150	2	2.007 [51.00]	1.890 [48.00]	1.901 [48.30]
IEC-D-S3-150	3	2.953 [75.00]	2.835 [72.00]	2.846 [72.30]
IEC-D-S4-150	4	3.897 [99.00]	3.780 [96.00]	3.791 [96.30]
IEC-D-S5-150	5	4.842 [123.00]	4.724 [120.00]	4.736 [120.30]
IEC-D-S6-150	6	5.787 [147.00]	5.670 [144.00]	5.681 [144.30]
IEC-D-S7-150	7	6.732 [171.00]	6.614 [168.00]	6.626 [168.30]

*PART NUMBERS SHOWN ARE FOR 1.5mm PANEL THICKNESS. CONSULT FACTORY FOR OTHER PANEL THICKNESSES REQUIREMENTS

NEMA-5-1 UNIVERSAL PANEL SNAP

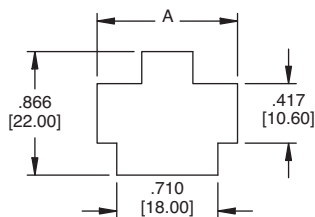
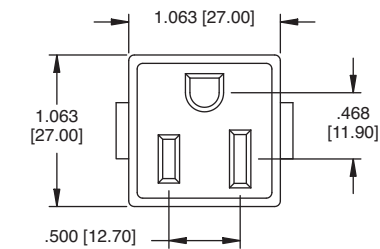

PANEL THICKNESS	DIM. A
.031 [0.80]	.945 [24.00]
.039 [1.00]	.968 [24.60]
.047 [1.20]	.992 [25.20]
.063 [1.60]	1.031 [26.20]

Recommended Panel Cut-Out For
1.50mm Panel Thickness

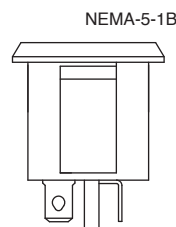
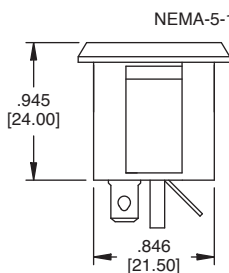
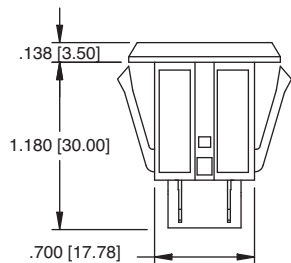

OPTIONAL STRAIGHT GROUND



NEMA-5-1

NEMA-5-2 UNIVERSAL PANEL SNAP 12-14 Awg

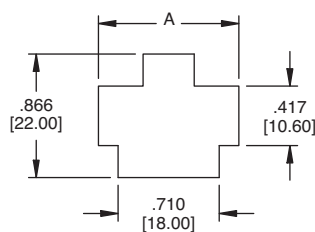
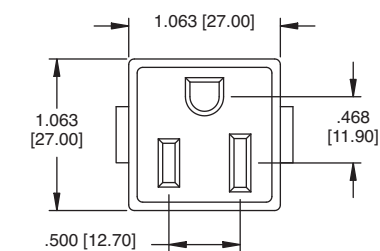

Recommended
Panel Cut-Out For
1.50mm Panel Thickness

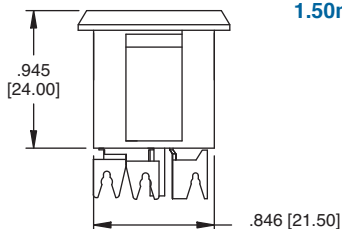
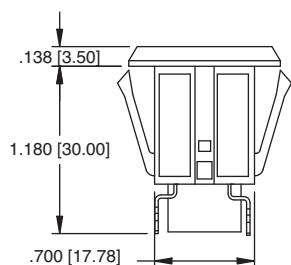

NEMA-5-2

NEMA-5-3 UNIVERSAL PANEL SNAP

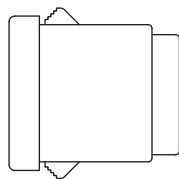
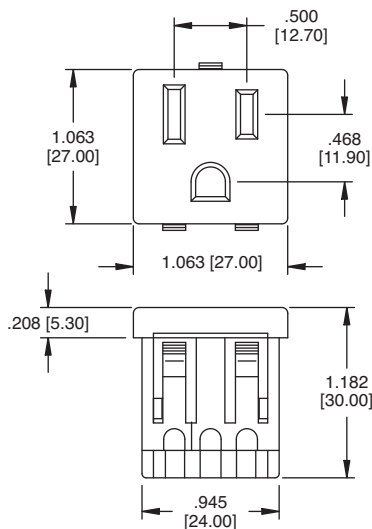

Recommended Panel Cut-Out For
Panel 0.8mm - 1.50mm

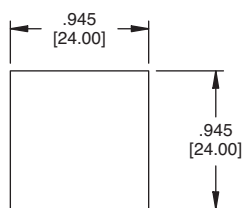

NEMA-5-3

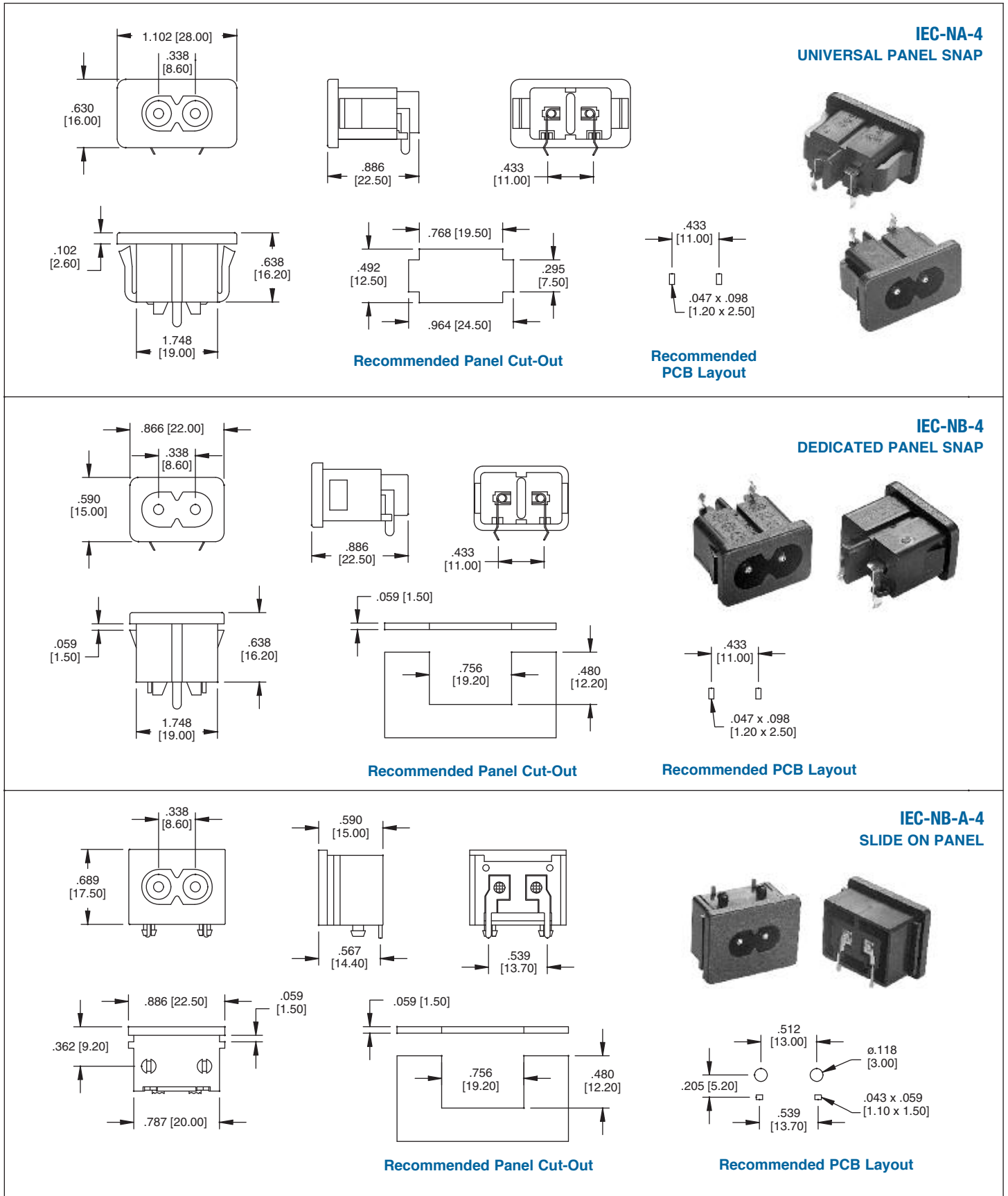

<p>Technical drawings for IEC-NC-4 connector showing front, side, and PCB layout views with dimensions in inches and millimeters.</p>	<p>IEC-NC-4 RIGHT ANGLE PANEL MOUNT</p> <p>Recommended PCB Layout</p> <p>Recommended Panel Cut-Out</p>
<p>Technical drawings for IEC-NC-A-4 connector showing front, side, and PCB layout views with dimensions in inches and millimeters.</p>	<p>IEC-NC-A-4 RIGHT ANGLE PANEL MOUNT</p> <p>Recommended PCB Layout</p> <p>Recommended Panel Cut-Out</p>
<p>Technical drawings for IEC-ND-4 connector showing front, side, and PCB layout views with dimensions in inches and millimeters.</p>	<p>IEC-ND-4 RIGHT ANGLE PANEL MOUNT</p> <p>Recommended PCB Layout</p> <p>Recommended Panel Cut-Out</p>

