

# Advanced Monolithic Systems

## AMS236/AMS336

### VOLTAGE REFERENCE DIODE

RoHS compliant

#### FEATURES

- Low Temperature Coefficient
- Wide Operating Current Range
- Guaranteed Temperature Stability
- Max.  $0.6\Omega$  Dynamic Impedance (A grade)
- $\pm 1\%$  Initial Tolerance Available

#### APPLICATIONS

- Power Supplies
- Instrumentation
- 8 Bit A/D, D/A Reference
- Current Loop Measurement and Control Systems
- Reference for 5V Systems

#### GENERAL DESCRIPTION

The AMS236/AMS336 are precision band-gap voltage reference diodes. These voltage reference features a very low dynamic impedance and good temperature coefficient, operating over a wide current range of  $400\mu\text{A}$  to  $10\text{mA}$ . On-chip trimming is used to provide tight tolerance and minimize temperature drift. A third terminal allows the reference voltage to be trimmed  $\pm 5\%$ .

The AMS236/AMS336 are used as a precision 2.5V low voltage reference for digital voltmeters, power supplies or op amp circuitry, and the 2.5V make it easy to obtain a stable reference from 5V logic supplies.

The AMS236 is rated for operation over  $-25^\circ\text{C}$  to  $+85^\circ\text{C}$  while the AMS336 is rated over a  $0^\circ\text{C}$  to  $70^\circ\text{C}$  temperature range. The AMS236/AMS336 are available in TO-92 and SO-8 packages.

#### ORDERING INFORMATION:

TOL.	PACKAGE TYPE		OPERATING TEMPERATURE RANGE
	TO-92	8 LEAD SOIC	
$\pm 25\text{mV}$	AMS236AN	AMS236AS	$-25^\circ\text{C}$ to $+85^\circ\text{C}$
$\pm 50\text{mV}$	AMS236BN	AMS236BS	$-25^\circ\text{C}$ to $+85^\circ\text{C}$
$\pm 50\text{mV}$	AMS336AN	AMS336AS	$0^\circ\text{C}$ to $70^\circ\text{C}$
$\pm 100\text{mV}$	AMS336BN	AMS336BS	$0^\circ\text{C}$ to $70^\circ\text{C}$

#### PIN CONNECTIONS

TO-92  
Plastic Package (N)

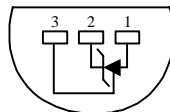

Bottom View

8L SOIC  
SO Package (S)

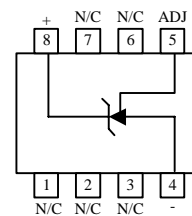

Top View

# AMS236/AMS336

## ABSOLUTE MAXIMUM RATINGS (Note 1)

Reverse Current	15mA	Storage temperature	-55°C to +150°C
Forward Current	10mA	Soldering information (25 sec)	265°C
Operating Temperature Range			
AMS236	-25°C to +85°C		
AMS336	0°C to +70°C		

## ELECTRICAL CHARACTERISTICS

Electrical Characteristics at  $I_R = 1$  mA, and  $T_A = +25^\circ\text{C}$  unless otherwise specified.

Parameter	Conditions	AMS236A			AMS236B			Units
		Min	Typ	Max	Min	Typ	Max	
Reverse Breakdown Voltage		2.475	2.500	2.525	2.450	2.500	2.550	V
Reverse Dynamic Impedance	$f = 100\text{Hz}$		0.2 <b>0.4</b>	0.6 <b>1</b>		0.2 <b>0.4</b>	0.6 <b>1</b>	$\Omega$
Reverse Breakdown Voltage Change with current	$400\mu\text{A} \leq I_R \leq 10\text{mA}$		2.6 <b>3</b>	6 <b>10</b>		2.6 <b>3</b>	6 <b>10</b>	mV
Temperature Stability	$-25^\circ\text{C} \leq T_A \leq +85^\circ\text{C}$		3.5	9		3.5	9	mV
Long Term Stability (Note 4)	$T_A = 25^\circ\text{C} \pm 0.1^\circ\text{C}$ $T = 1000$ Hr		20			20		ppm

## ELECTRICAL CHARACTERISTICS

Electrical Characteristics at  $I_R = 1$  mA, and  $T_A = +25^\circ\text{C}$  unless otherwise specified.

Parameter	Conditions	AMS336A			AMS336B			Units
		Min	Typ	Max	Min	Typ	Max	
Reverse Breakdown Voltage		2.450	2.500	2.550	2.400	2.500	2.600	V
Reverse Dynamic Impedance	$f = 100\text{Hz}$		0.2 <b>0.4</b>	1.0 <b>1.4</b>		0.2 <b>0.4</b>	1.0 <b>1.4</b>	$\Omega$
Reverse Breakdown Voltage Change with current	$400\mu\text{A} \leq I_R \leq 10\text{mA}$		2.6 <b>3</b>	10 <b>12</b>		2.6 <b>3</b>	10 <b>12</b>	mV
Temperature Stability	$0^\circ\text{C} \leq T_A \leq 70^\circ\text{C}$		1.8	6		1.8	6	mV
Long Term Stability (Note 4)	$T_A = 25^\circ\text{C} \pm 0.1^\circ\text{C}$ $T = 1000$ Hr		20			20		ppm

**Note 1:** Absolute Maximum Ratings indicate limits beyond which damage to the device may occur. Operating Ratings indicate conditions for which the device is intended to be functional, but do not guarantee specific performance limits. For guaranteed specifications and test conditions, see the Electrical Characteristics. The guaranteed specifications apply only for the test conditions listed.

**Note 2:** For elevated temperature operation,  $T_j$  max is:

AMS236 +125°C

AMS336 +100°C

Thermal Resistance	TO-92	SO-8
$\theta_{JA}$ (junction to ambient)	170°C/W (0.125" leads)	165°C/W

**Note 3:** Parameters identified with **boldface type** apply at temperature extremes. All other numbers apply at  $T_A = T_j = 25^\circ\text{C}$ .

**Note 4:** Temperature stability for the AMS236/336 family is guaranteed by design. Design limits are guaranteed (but not 100% production tested) over the specified temperature and supply voltage ranges. These limits are not used to calculate outgoing quality levels. The average temperature coefficient is defined as the maximum deviation of reference voltage at all measured temperatures between the operating  $T_{MAX}$  and  $T_{MIN}$ , divided by  $T_{MAX} - T_{MIN}$ .

## TYPICAL PERFORMANCE CHARACTERISTICS

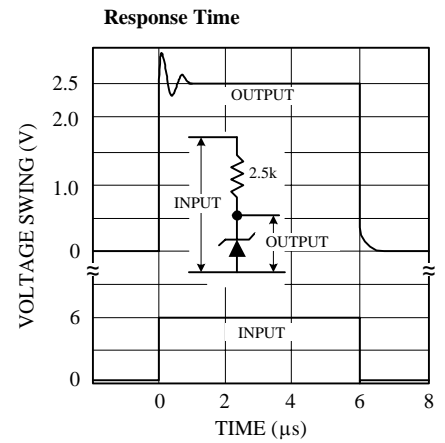
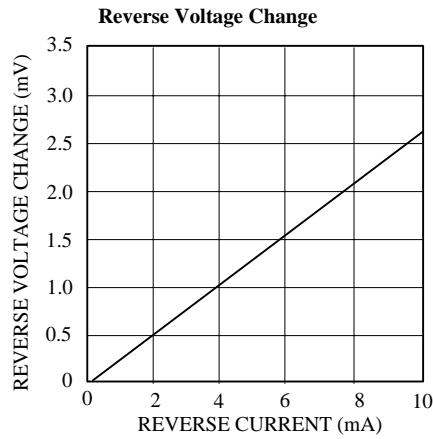
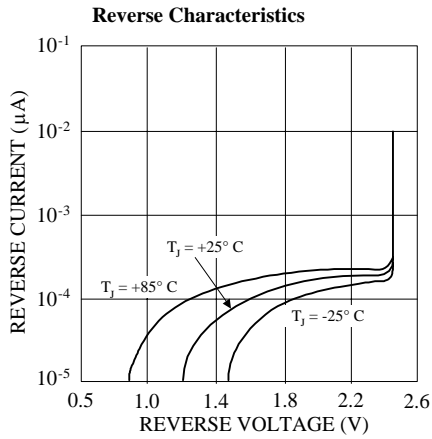

## TYPICAL APPLICATIONS

### 2.5V Reference

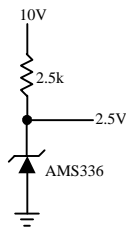

### Wide Input Range Reference

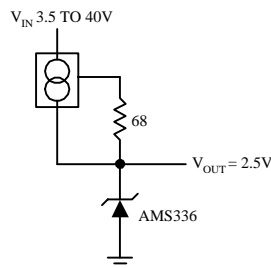

### 2.5V Reference with Minimum Temperature Coefficient

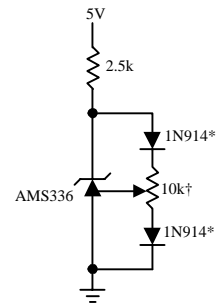

$\dagger$  Adjust to 2.50V  
\* Any silicon signal diode

### Precision Power Regulator with Low Temperature Coefficient

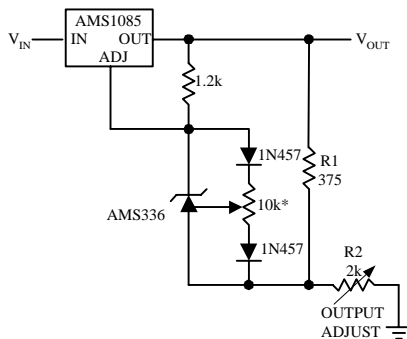

### Trimmed 2.5V Reference with Temperature Coefficient Independent of Breakdown Voltage

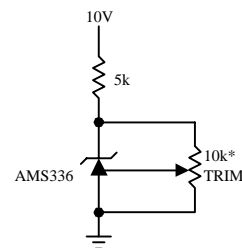

\*Does not affect Temperature Coefficient

