



FPF2024/5/6/7 Full Functional Load Switch With 100mA Current Limit

Features

- 1.6V to 5.5V Input Voltage Range
- Ultra Low Average Quiescent Current 1µA typ @1.8V
- Typical $R_{DS(ON)} = 225m\Omega$ @ $V_{IN} = 3.3V$
- Typical $R_{DS(ON)} = 280m\Omega$ @ $V_{IN} = 1.8V$
- 100mA Fixed Current Limit Minimum
- Under Voltage Lockout
- CMOS and Open Drain Fault Flag Options
- Fault Blanking
- Auto Restart
- Thermal Shutdown
- ESD Protection above 5500V HBM and 1500V CDM

Applications

- PDAs
- Cell Phones
- GPS Devices
- Digital Cameras
- Peripheral Ports
- MP3 Players



General Description

The FPF2024/5/6/7 are low $R_{DS(ON)}$ P-Channel MOSFET load switches with 150mA typical current limit value targeting small package load switch applications. The extended input voltage range spans from 1.6V to 5.5V to fulfill today's Ultra Portable Device's supply requirements. Switch control is by a logic input (ON) capable of interfacing directly with a low voltage control signal.

The FPF2024/5/6/7 respond to an output overload condition by going into constant current mode where the output current is regulated by the load switch. If the overcurrent condition persists beyond the 10ms Blanking Time, FPF2024 and FPF2025 pull the fault signal pin (FLAGB) low and shut-off the switch. An Auto-Restart feature turns FPF2024 and FPF2025 on again after 70ms if the ON pin is still active. The FPF2026 has a Latch-Off feature which shuts off the switch off after the expiration of the 10ms Blanking Time and keeps it off until the ON pin is toggled. The FPF2027 responds to an overload condition by immediately pulling the fault signal pin low and the switch remains in constant current mode until the output overload condition is removed. FPF2027 has a Startup Blanking feature which prevents startup transient overcurrent conditions from triggering the fault signal pin for 10ms after initial turn on via the ON pin.

These parts are available in a space-saving 6 ball advanced. Pb-Free 1.0x1.5 mm² CSP package.

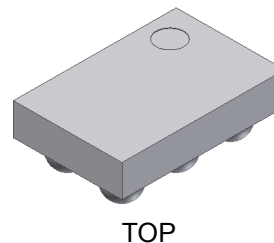
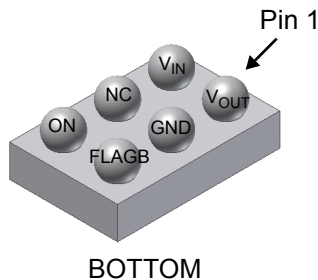

Ordering Information

Part	Min Current Limit [mA]	Blanking Current Limit Time [ms]	Auto-Restart Time [ms]	ON Pin Activity	FLAGB	Top Mark
FPF2024	100	10	70	Active HI	Open Drain	S2
FPF2025	100	10	70	Active LO	CMOS	S3
FPF2026	100	10	NA	Active HI	Open Drain	S4
FPF2027	100	0	NA	Active HI	Open Drain	S5

Typical Application Circuit

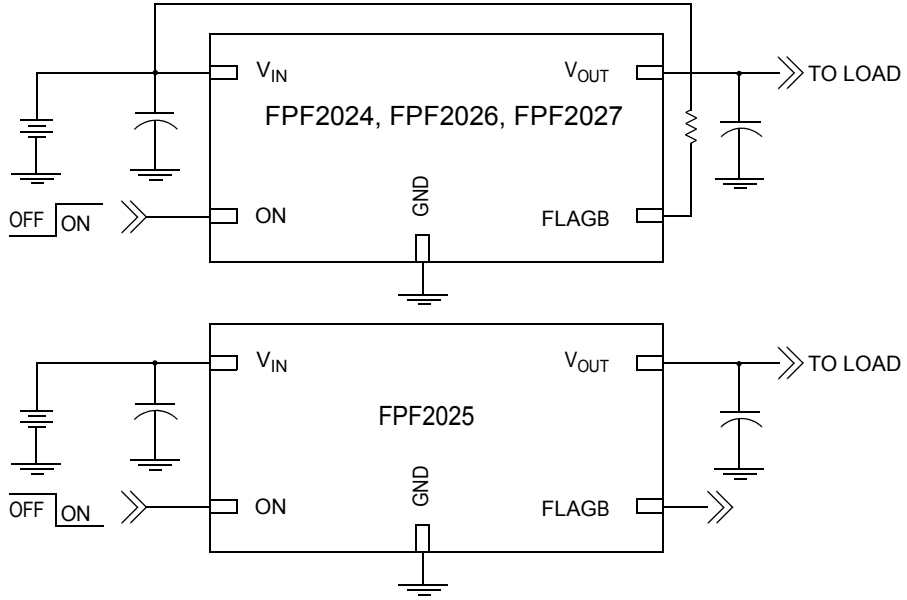

Functional Block Diagram

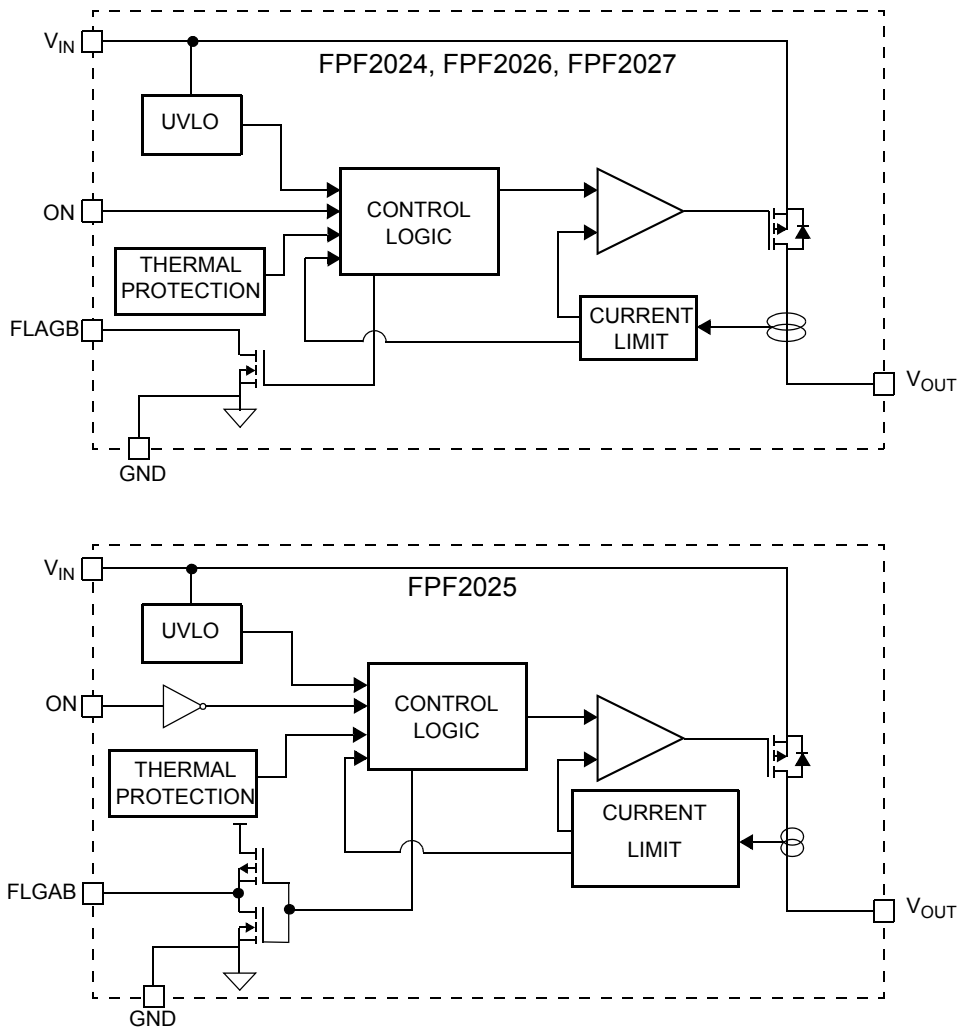

Pin Configuration

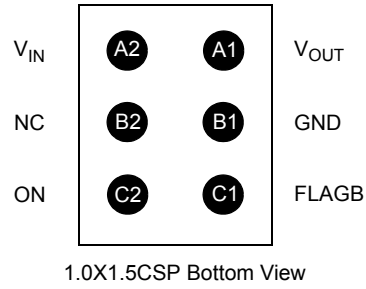

Pin Description

Pin	Name	Function
A1	V _{OUT}	Switch Output: Output of the power switch
A2	V _{IN}	Supply Input: Input to the power switch and the supply voltage for the IC
B1	GND	Ground
B2	NC	No Connection
C1	FLAGB	Fault Output: Active LO, open drain output for FPF2024/6/7 and CMOS output for FPF2025. FLAGB indicates an over current, supply under voltage or over temperature state
C2	ON	ON/OFF Control Input, Active High for FPF2024/6/7 and Active LO for FPF2025

Absolute Maximum Ratings

Parameter	Min.	Max.	Unit
V _{IN} , V _{OUT} , ON, FLAGB to GND	-0.3	6	V
Power Dissipation @ T _A = 25°C (Note 1)		1.2	W
Maximum Continuous Switch Current		0.2	A
Operating Temperature Range	-40	125	°C
Storage Temperature	-65	150	°C
Thermal Resistance, Junction to Ambient		85	°C/W
Electrostatic Discharge Protection	HBM	5500	V
	CDM	1500	V

Note1: Package power dissipation on 1square inch pad, 2 oz. copper board.

Recommended Operating Range

Parameter	Min.	Max.	Unit
V _{IN}	1.6	5.5	V
Ambient Operating Temperature, T _A	-40	85	°C

Electrical Characteristics

$V_{IN} = 1.6$ to $5.5V$, $T_A = -40$ to $+85^\circ C$ unless otherwise noted. Typical values are at $V_{IN} = 3.3V$ and $T_A = 25^\circ C$.

Parameter	Symbol	Conditions	Min.	Typ.	Max.	Units
Basic Operation						
Operating Voltage	V_{IN}		1.6		5.5	V
Quiescent Current	I_Q	$I_{OUT} = 0mA$, V_{ON} Active, $V_{IN} = 1.8V$ (Average)		1	4	μA
Shutdown Current	I_{SHDN}	$V_{ON} = V_{IN}$ (FPF2025) $V_{ON} = GND$ (FPF2024/6/7), $I_{OUT} = 0$			1	μA
On-Resistance	R_{ON}	$T_A = 25^\circ C$, $V_{IN} = 5.5V$		215	315	m Ω
		$T_A = -40$ to $+85^\circ C$, $V_{IN} = 5.5V$	120	215	350	
		$T_A = 25^\circ C$, $V_{IN} = 3.3V$		225	325	
		$T_A = -40$ to $+85^\circ C$, $V_{IN} = 3.3V$	140	225	360	
		$T_A = 25^\circ C$, $V_{IN} = 1.6V$		305	490	
		$T_A = -40$ to $+85^\circ C$, $V_{IN} = 1.6V$	180	305	580	
ON Input Logic High Voltage (ON)	V_{IH}	$V_{IN} = 1.6V$	0.8			V
		$V_{IN} = 5.5V$	1.5			
ON Input Logic Low Voltage	V_{IL}	$V_{IN} = 1.6V$			0.45	V
		$V_{IN} = 5.5V$			0.9	
ON Input Leakage		$V_{ON} = V_{IN}$ or GND			1	μA
Off Switch Leakage	I_{SWOFF}	$V_{ON} = V_{IN}$, $V_{OUT} = 0V$			1	μA
FLAGB Output Logic Low Voltage		$V_{IN} = 5.5V$, $I_{SINK} = 1mA$		0.1	0.2	V
		$V_{IN} = 1.8V$, $I_{SINK} = 1mA$		0.1	0.3	
FLAGB Output Logic High Voltage		$V_{IN} = 5.5V$, $I_{SOURCE} = 1mA$, FPF2025	5.2	5.4		V
		$V_{IN} = 1.6V$, $I_{SOURCE} = 1mA$, FPF2025	1.2	1.35		
FLAGB Output High Leakage Current		$V_{IN} = 5.5V$, Switch on, FPF2024, FPF2026, FPF2027			1	μA
Protections						
Current Limit	I_{LIM}	$V_{IN} = 3.3V$, $V_{OUT} = 3.0V$, $T_A = 25^\circ C$	100	150	200	mA
Thermal Shutdown		Shutdown Threshold T_J increasing		140		$^\circ C$
		Return from Shutdown		130		
		Hysteresis		10		
Under Voltage Lockout	UVLO	V_{IN} Increasing	1.475	1.525	1.575	V
Under Voltage Lockout Hysteresis				40		mV
Dynamic						
Turn On Time	t_{ON}	$R_L = 500\Omega$, $C_L = 0.1\mu F$		70		μs
Turn Off Time	t_{OFF}	$R_L = 500\Omega$		10		μs
V_{OUT} Rise Time	t_{RISE}	$R_L = 500\Omega$, $C_L = 0.1\mu F$		30		μs
Over Current Blanking Time	t_{BLANK}	FPF2024, FPF2025, FPF2026	5	10	20	ms
Startup FLAGB Blanking Time	t_{START_BLANK}	FPF2027 (Note2)	5	10	20	ms
Auto-Restart Time	t_{RSTRT}	FPF2024, FPF2025	35	70	140	ms
Sleep Mode Duration			128.5	257	514	ms
Wake-up Mode Duration			0.5	1	2	ms
Duty Cycle		Wake-up: Sleep Mode Duty Cycle		1:257		
Current Limit Response Time		Moderate Over-current condition $R_L = 50\Omega$		15		μs
Blanking/Auto-Restart Duty Ratio		t_{BLANK} / t_{RSTRT} (internally fixed) FPF2024, FPF2025		1:7		

Note2: FPF2027 has a 10ms Startup FLAGB Blanking Time when the part is turned on via ON pin to ensure transient load currents settle down.

Typical Characteristics

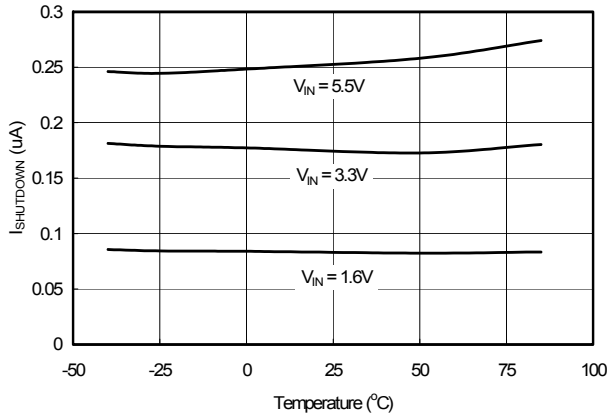

Figure 1. Shutdown Current vs. Temperature

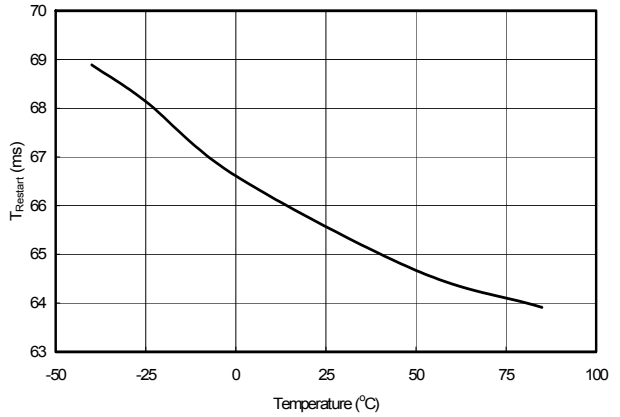

Figure 2. T_{Restart} vs. Temperature

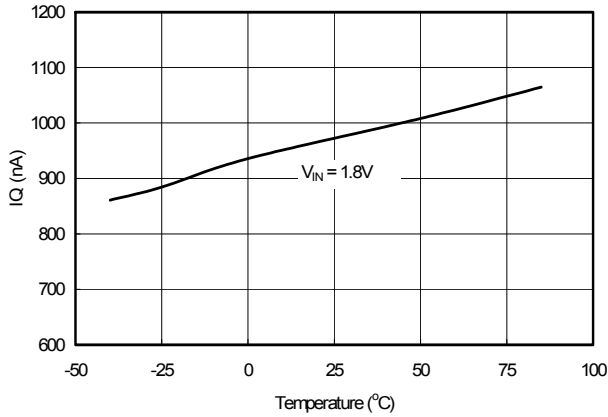

Figure 3. Quiescent Current vs. Temperature

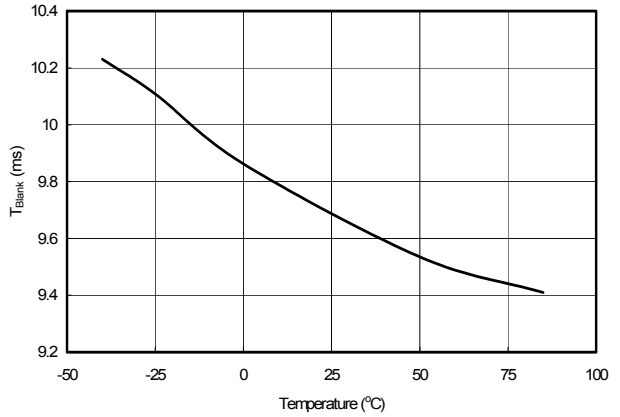

Figure 4. T_{Blank} vs. Temperature

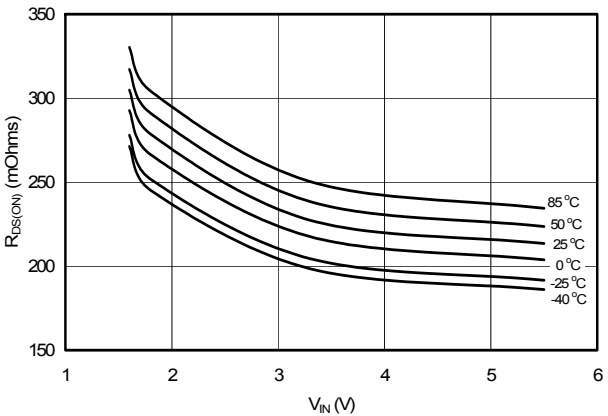

Figure 5. R_{DS(ON)} vs. V_{IN}

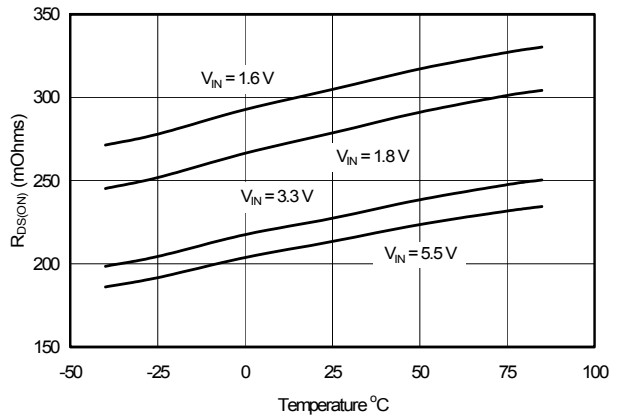

Figure 6. R_{DS(ON)} vs. Temperature

Typical Characteristics

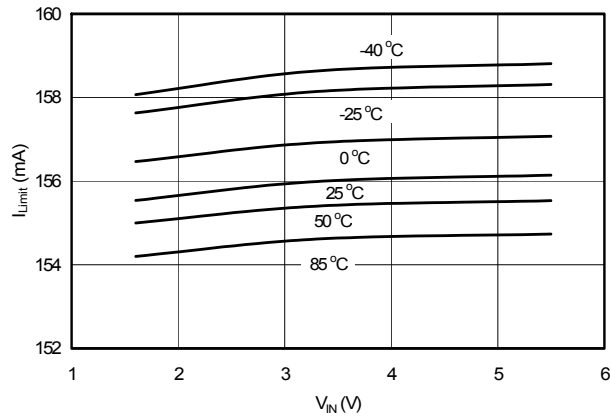

Figure 7. I_{Limit} vs. V_{IN}

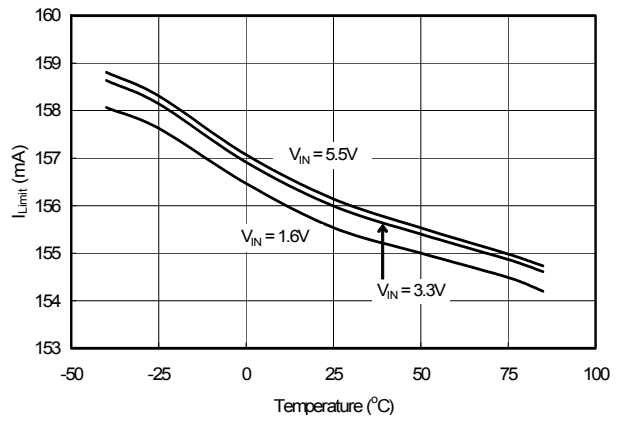

Figure 8. I_{Limit} vs. Temperature

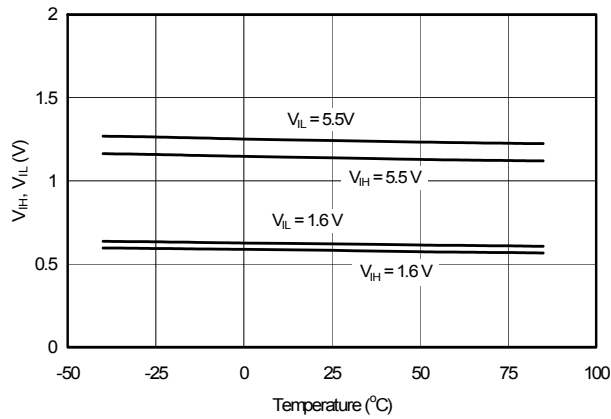

Figure 9. V_{IH}, V_{IL} vs Temperature

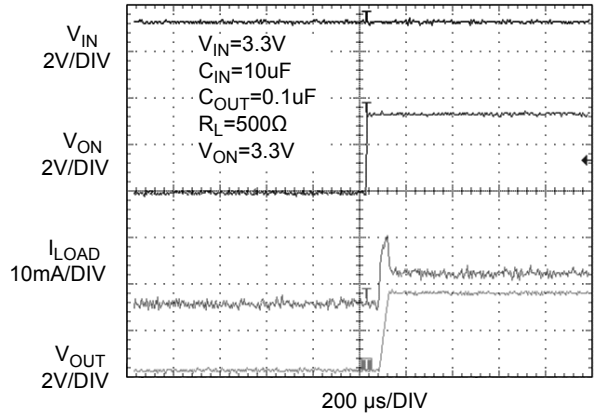

Figure 10. FPF2024 T_{ON} Response

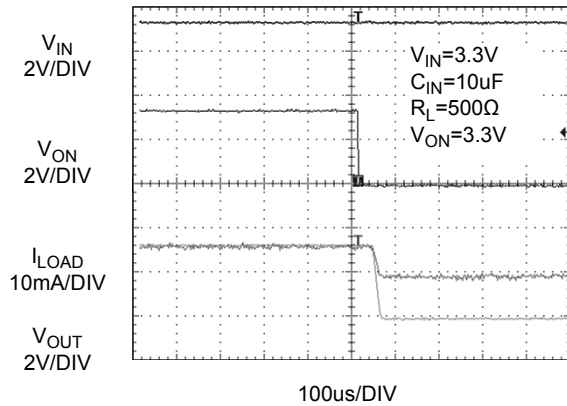

Figure 11. FPF2024 T_{OFF} Response

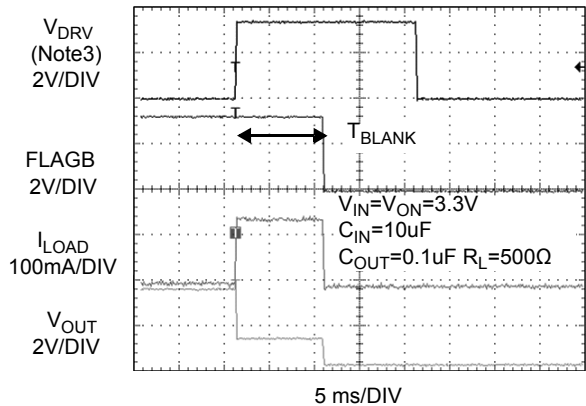

Figure 12. FPF2024 T_{BLANK} Response

Note3: V_{DRV} signal forces the device to go into overcurrent condition by loading a 7.5 Ω .

Typical Characteristics

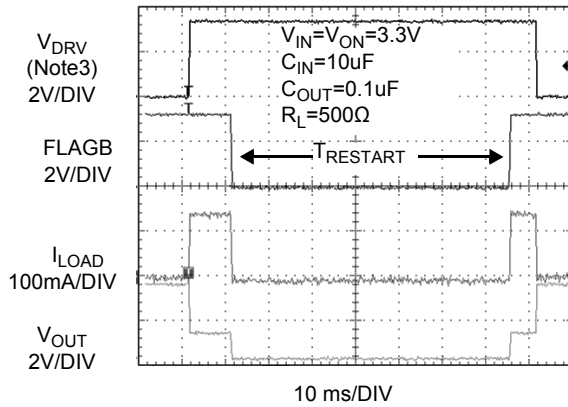

Figure 13. PPF2024 $T_{RESTART}$ Response

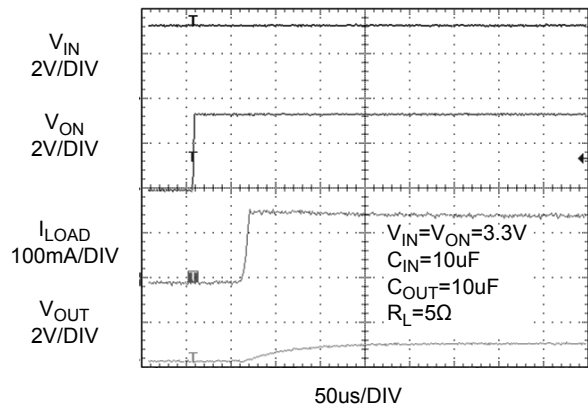

Figure 14. PPF2024 Current Limit Response Time (Output is loaded by 5Ω and $C_{OUT} = 10\mu F$)

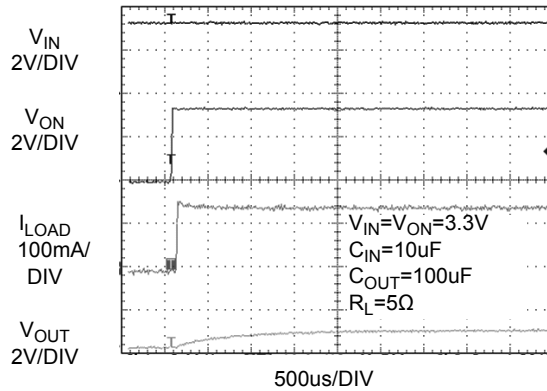

Figure 15. PPF2024 Current Limit Response Time (Output is loaded by 5Ω and $C_{OUT} = 100\mu F$)

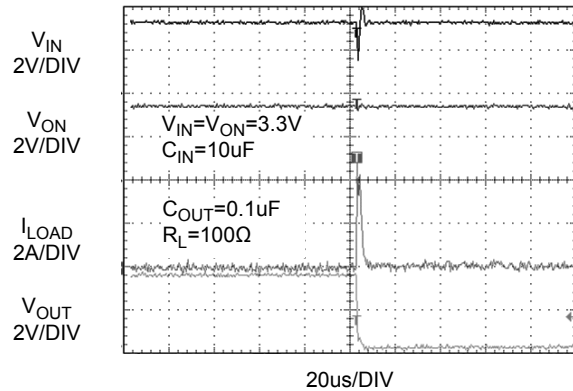

Figure 16. PPF2024 Short Circuit Response Time (Output shorted to GND while the switch is in normal operation)

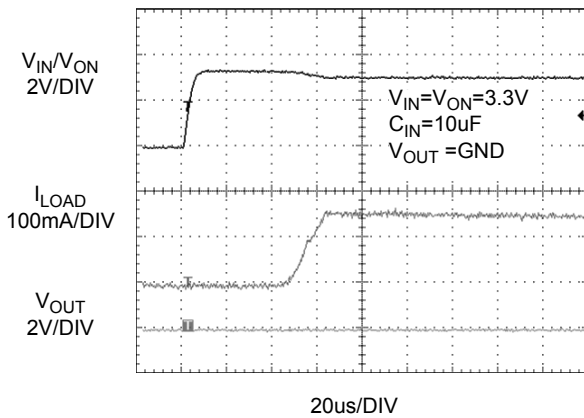

Figure 17. PPF2024 Current Limit Response (Input and enable pin are tied together and V_{OUT} is shorted to GND)

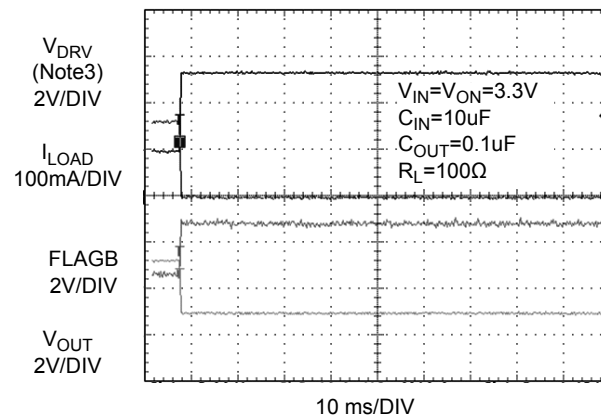

Figure 18. PPF2027 Over-Current (Over-Current condition is applied while device in normal operation (FLAGB inserts immediately and reports the fault condition))

Typical Characteristics

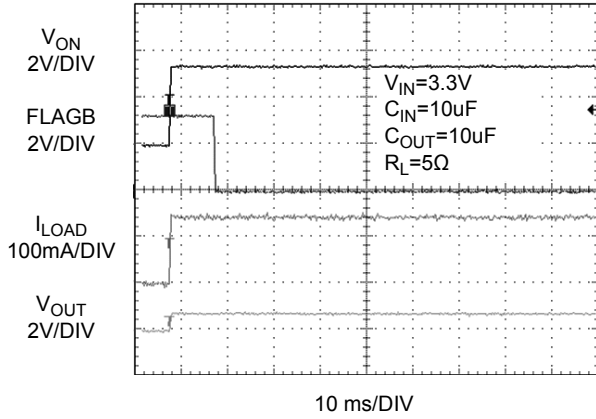

Figure 19. FPF2027 Startup FLAGB Blanking Time

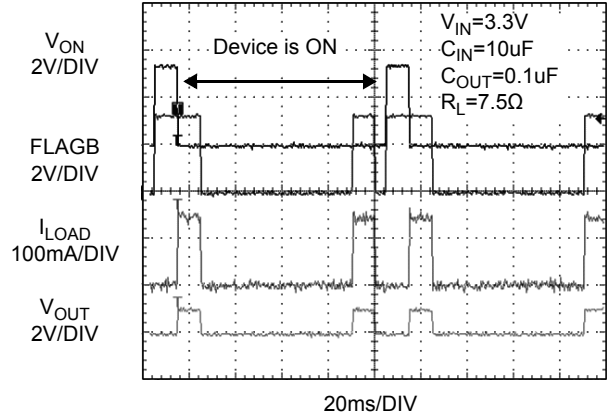

Figure 20. FPF2025 T_{BLANK} and $T_{RESTART}$ (Active LO Device)

Description of Operation

FPF2024-FPF2027 series Full-Function switches are current limited load switches with ultra-low power consumption. The core of each device consists of a 230mW P-channel MOSFET featuring slow turn-on to limit the inrush current, fast turn-off, current limit, UVLO(under-voltage lockout) and thermal shutdown protection features and a FLAGB output that indicates that a fault condition has occurred.

Some versions in the FPF202x series also feature Current Limit Blanking and Auto-Restart.

The FPF202x family achieves an ultra-low current consumption of 1 μ A through a proprietary "Sleep-Wakeup modes" implementation. Full functionality is guaranteed for operating voltages down to 1.6V over the -40°C to +85°C temperature range.

Sleep and Wakeup Mode Description

The ultra-low power consumption of FPF2024-FPF2027 is achieved through the implementation of proprietary Sleep/Wakeup modes.

The FPF2024-FPF2027 family turns on in Startup mode where it checks for potential load current, temperature, and under-voltage faults for 10ms. If no faults are detected during this startup period, the FPF2024-FPF2027 goes into a Sleep mode where it stays for 257ms. At the end of the Sleep period, the part goes into Wakeup mode to check for any fault condition. If no fault is detected in 1ms, the part goes back to Sleep mode. The 1:257 Wakeup/Sleep duty cycle results in an overall average current consumption of 1 μ A (typ).

During Sleep mode the thermal and under-voltage conditions are not monitored to reduce the current consumption of the device.

The switch current limiting circuitry is active at all times and protects the FPF2024-FPF2027 against excessive load currents in all modes.

While in the Wakeup mode, a current fault event will prevent the part from re-entering into Sleep mode even if input voltage and temperature faults are not present. In such a case, the part functions according to its feature set, e.g., it performs its normal Blanking, Auto-Restart or Latch-off functions as expected. If the over-current condition is removed from the output, the part will go back into Sleep mode after 10ms. The representative state diagrams of the FPF2024-FPF2027 are given in Figure 21, Figure 22 and Figure 23.

The ultra-low quiescent current consumption of 1 μ A along with the very-low minimum operating voltage of 1.6V, make the FPF2024-FPF2027 an ideal full-function load switch for ultra-portable applications.

On/Off Control

The ON pin controls the state of the switch. The FPF2024-FPF2027 series features both active high and low configurations to accommodate various application requirements. FPF2024, FPF2026 and FPF2027 are active high switches while the FPF2025 is an active low device. Applying a continuous high or low signal depending on the switch configuration, will hold the switch in the ON state. The load switch will move into the OFF state when the ON pin is inactive. In addition, FPF2026 moves into the OFF state if a current fault is encountered for longer duration than the Blanking Time. For all versions, an undervoltage on V_{IN} or a junction temperature in excess of 140°C overrides the ON control and turns off the switch.

In addition, a current fault condition longer than the Blanking Time will cause the switch to turn off in the FPF2024, FPF2025 and FPF2026. The FPF2024 and FPF2025 have an Auto-Restart feature which will automatically turn the switch on again after 70ms. For the FPF2026, the ON pin must be toggled to turn the switch on again. The FPF2027 does not turn off in response to an over current condition, and remains in a constant current mode for so long as the ON pin is active, and the thermal shutdown or UVLO are not activated.

The ON pin control voltage and V_{IN} pin have independent recommended operating ranges. The ON pin voltage can be driven by a voltage level higher than the input voltage.

Fault Reporting

Over-current, input under-voltage, or over-temperature fault conditions are signaled out by the FLAGB pin going low.

FPF2024, FPF2025 and FPF2026 have a current fault blanking feature which prevents current faults lasting shorter than the Blanking Time of 10ms (typ) from triggering the fault signal (FLAGB) output.

If the over-current condition persists beyond the Blanking Time, the FPF2024 and FPF2025 pull the FLAGB pin low and shut the switch off. If the ON pin is kept active, an Auto-Restart feature releases the FLAGB pin and turns the switch on again after 70ms.

If the over-current condition persists beyond the Blanking Time, the FPF2026 has a Latch-Off feature which pulls the FLAGB pin low and shuts the switch off. The switch is kept off and the FLAGB pin is kept low until the ON pin is toggled.

The FPF2027 responds to an overload condition by immediately pulling the FLAGB pin low and the switch remains in constant current mode until the output overload condition is removed. The FPF2027 has a Start-Up Blanking feature which prevents current faults related to start-up transients from triggering the FLAGB output. The Startup Blanking feature is effective for the first 10ms (typ) following device turn-on via ON pin.

The FPF2024, FPF2026 and FPF2027 have an open-drain MOSFET FLAGB output which requires a pull-up resistor between V_{IN} and FLAGB. A 100K Ω pull up resistor is recommended. The FPF2025 has a CMOS FLAGB output and does not require a pull-up resistor. During shutdown, the pull-down on FLAGB is disabled to reduce current draw from the supply.

Current Limiting

The current limit function ensures that the current through the switch does not exceed a maximum value while not limiting at less than a minimum value. The minimum current at which the parts will limit the load current is internally set to 100mA.

The switch current limiting circuitry is active at all times (Sleep and Wakeup mode) and protects the FPF2024-FPF2027 against excessive load currents in all modes. The proprietary current limiting circuit responds to an over-current condition in 15 μ s (typ).

Undervoltage Lockout (UVLO)

The undervoltage lockout feature turns-off the switch if the input voltage drops below the undervoltage lockout threshold. With the ON pin active, the input voltage rising above the undervoltage lockout threshold will cause a controlled turn-on of the switch and will limit current over-shoots. The UVLO feature is disabled during Sleep mode. If device is in the UVLO condition, FLAGB goes low and indicates the fault. If the input voltage goes below UVLO voltage but remains above 1.3V (typ) during Sleep mode, the switch is kept on until the next Wakeup cycle, where the UVLO violation will be detected. If the input voltage falls below 1.3V in Sleep mode, the switch is immediately turned off.

Thermal Shutdown

The Thermal Shutdown protects the device from internally or externally generated excessive temperatures. The Thermal shutdown feature is disabled during Sleep mode. However, excessive load currents that may result in high power dissipation will be detected during Sleep mode and will activate the full-function Wakeup mode, which has thermal shutdown protection. During an over-temperature condition the FLAGB is pulled low and the switch is turned-off. If the temperature of the die drops below the threshold temperature, the switch automatically turns-on again. To avoid unwanted thermal oscillations, a 10°C (typ) thermal hysteresis is implemented between thermal shutdown entry and exit temperatures.

Description of Operation cont.

State Diagram for the part options with Blanking and Auto-Restart (FPF2024/5)

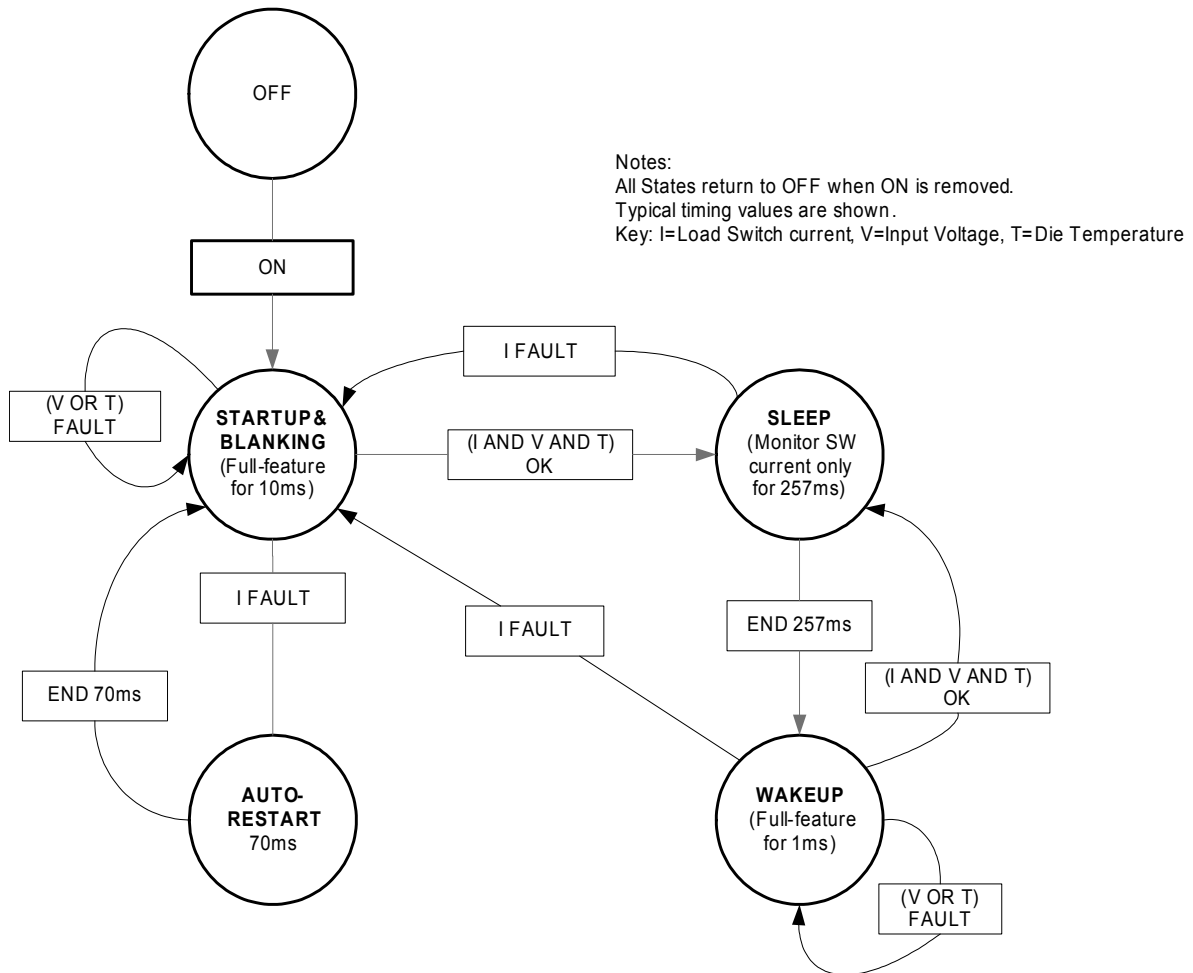

Figure 21. Representative State Diagram of FPF2024/5

Description of Operation cont.

State Diagram for the part options with Blanking only(no Auto-Restart -FPF2026)

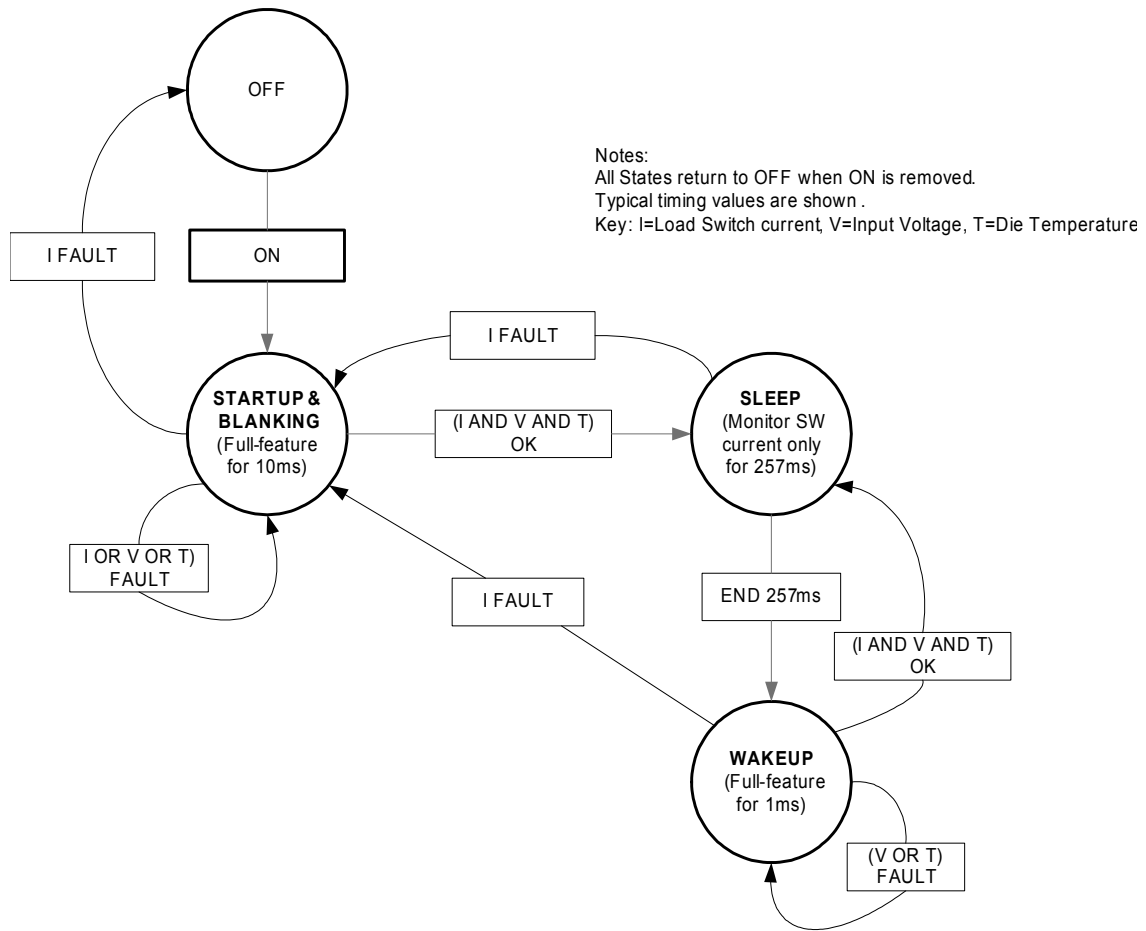
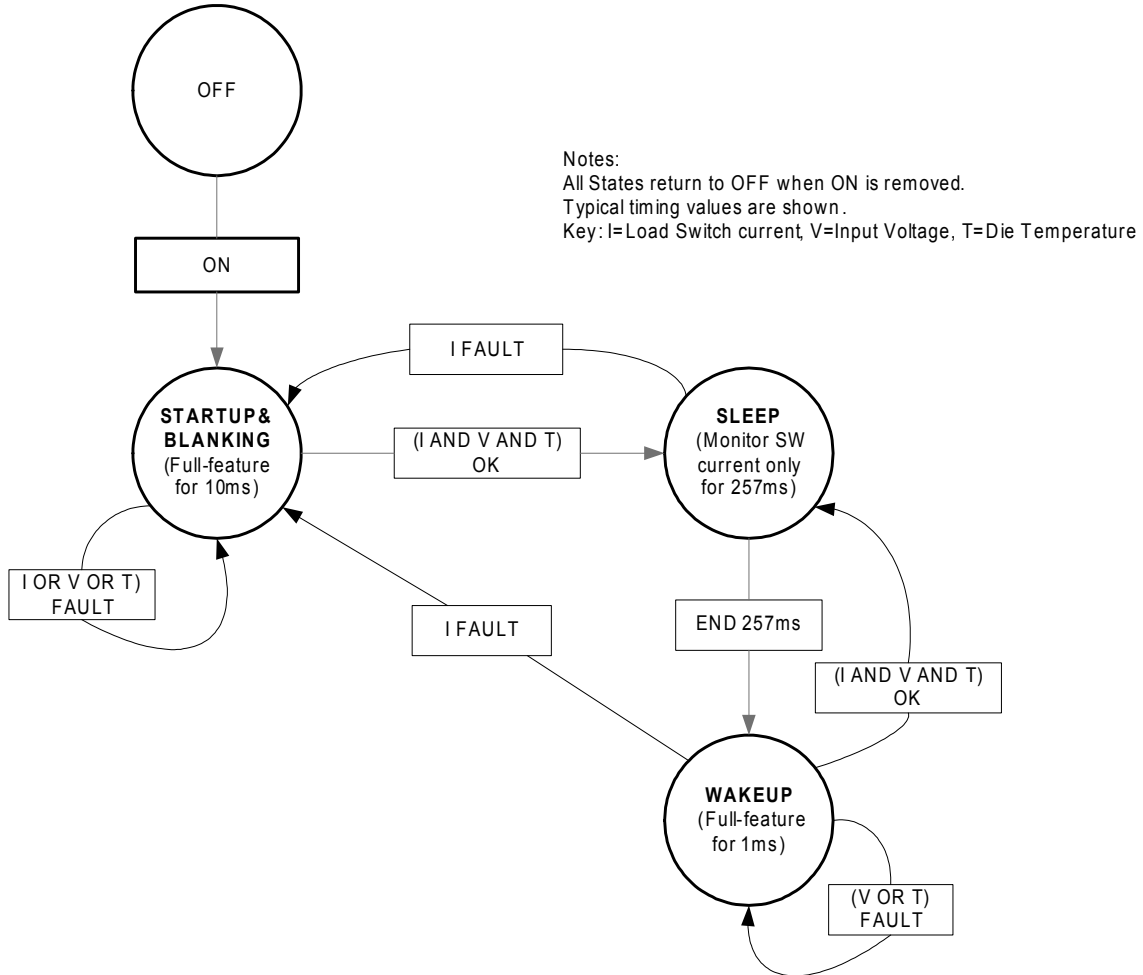

Figure 22. Representative State Diagram of FPF2026

Description of Operation cont.

State Diagram for the part options with no Blanking (FPF2027)



Notes:
 All States return to OFF when ON is removed.
 Typical timing values are shown.
 Key: I=Load Switch current, V=Input Voltage, T=Die T Temperature

Figure 23. Representative State Diagram of FPF2027

Application Information

Input Capacitor

To limit the voltage drop on the input supply caused by transient in-rush currents when the switch is turned on into a discharged load capacitor or a short-circuit, a capacitor is recommended to be placed between V_{IN} and GND. The FPF2024-FPF2027 series feature a slow turn-on to limit the inrush current and requires a smaller input capacitor. A 1uF ceramic capacitor, C_{IN} , placed close to the pins is typically sufficient. Higher values of C_{IN} can be used to further reduce the voltage drop.

Output Capacitor

A 0.1uF capacitor C_{OUT} should be placed between V_{OUT} and GND. This capacitor will prevent parasitic board inductances from forcing V_{OUT} below GND when the switch turns-off. For the FPF2024, FPF2025 and FPF2026, the total output capacitance needs to be kept below a maximum value, $C_{OUT(max)}$, to prevent the part from registering an over-current condition beyond the Blanking Time and turning-off the switch. The maximum output capacitance can be determined from the following formula:

$$C_{OUT(Max)} = \frac{I_{LIM(Max)} \times t_{BLANK(Min)}}{V_{IN}}$$

Power Dissipation

During normal operation as a switch, the power dissipation is small and has little effect on the operating temperature of the part. The maximum power dissipation while switch is in normal operation occurs just before a part enters the current limit. This may be calculated using the formula below:

$$P_{Max(Normal\ Operation)} = (I_{LIM(Max)})^2 \times R_{ON(Max)} \\ = (0.2)^2 \times 0.58 = 23.2\ mW, \text{ for } V_{IN}=1.6V$$

If the part goes into current limit, the maximum power dissipation occurs when the output of switch is shorted to ground. For the FPF2024 and FPF2025, the power dissipation will scale with the Auto-Restart Time, t_{RSTRT} , and the Over Current Blanking Time, t_{BLANK} . In this case the maximum power dissipated for the FPF2024 and FPF2025 is:

$$P_{Max(Current\ limit)} = \frac{t_{BLANK}}{t_{BLANK} + t_{RSTRT}} \times V_{IN(Max)} \times I_{LIM(Max)} \\ = \frac{10}{10 + 70} \times 5.5 \times 0.2 = 137\ mW$$

Take note that this is below the maximum package power dissipation, and the thermal shutdown feature protection provides additional safety to protect the part from damage due to excessive heating. The junction temperature is only able to increase to the thermal shutdown threshold. Once this temperature has been reached, toggling ON will have no affect until the junction temperature drops below the thermal shutdown exit temperature. For the FPF2027, a short on the output will cause the part to operate in a constant current state dissipating a worst case power of:

$$P_{Max} = V_{IN(Max)} \times I_{LIM(Max)} = 5.5 \times 0.2 = 1.1\ W$$

Output of FPF2027 is shorted to GND.

This power dissipation is significant enough that it will activate the thermal shutdown protection, and the part will cycle in and out of thermal shutdown so long as the ON pin is active and the output short is present.

Improving Thermal Performance

An improper layout could result in higher junction temperature and ultimately trigger the thermal shutdown protection feature. This concern applies particularly significant for the FPF2027 where the switch is in constant current mode in the overload conditions.

The following techniques have been identified to improve the thermal performance of this family of devices. These techniques are listed in order of the significance of their impact.

- NC pin can be connected to the GND plane to improve thermal performance.
- The V_{IN} , V_{OUT} and GND pins will dissipate most of the heat generated during a high load current condition. Using wide traces will help minimize parasitic electrical effects, along with minimizing the case to ambient thermal impedance. The layout suggested in Figure 24 provides each pin with adequate copper so that heat may be transferred out of the device as efficiently as possible. The low-power FLAGB and ON pin traces may be laid-out to maximize the area available to the ground pad.
- Placing the input and output capacitors as close to the device as possible also contributes to heat dissipation, particularly during high load currents.

FPF202X Demo Board

FPF202X Demo board has components and circuitry to demonstrate the functions and features of the FPF202X load switch family. An N-Channel MOSFET(Q), in series with a 7.5Ω resistor, are connected between V_{OUT} and the GND pin of the device. By turning on the Q transistor, the 7.5Ω is loaded to the output voltage and simulates an over-current condition. The R2 resistor is connected between FLAGB pin and input voltage as pull-up resistor for FPF2024, FPF2026 and FPF2027 devices. The FPF2025 does not require a pull-up resistor due to its CMOS output structure.

The thermal performance of the board is improved using the techniques recommended in the layout recommendations section of datasheet.

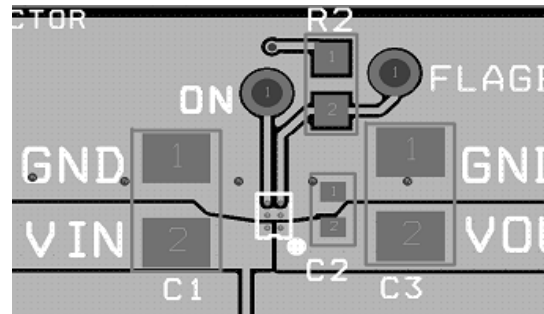

Figure 24. FPF202X proper layout

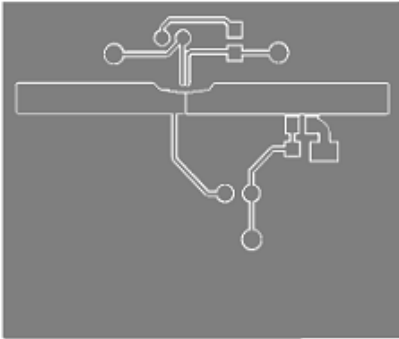

Figure 25. Top Layer



Figure 28. TOP, SST and SMT

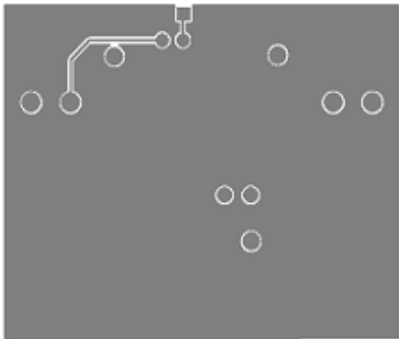

Figure 26. Bottom Layer

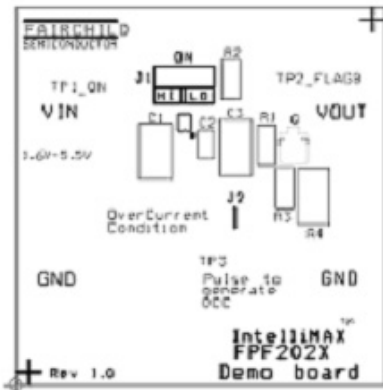
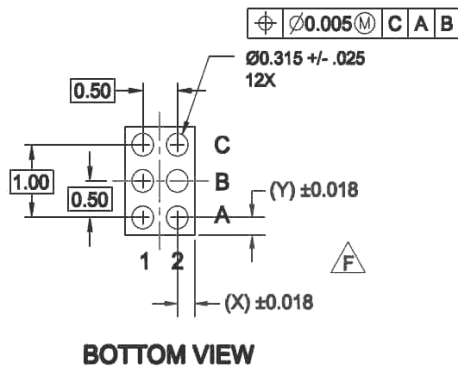
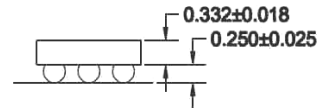
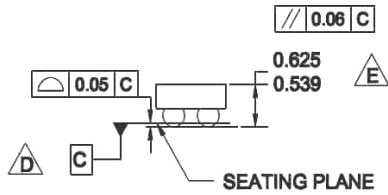
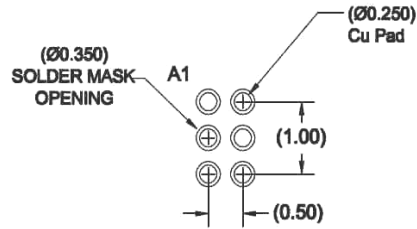
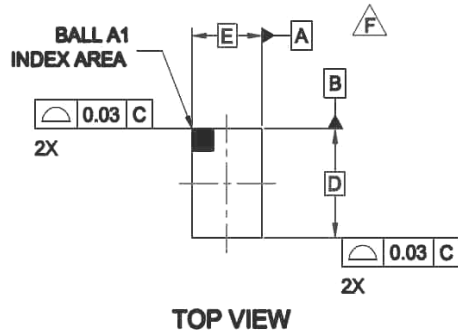

Figure 27. SST

Dimensional Outline and Pad Layout



NOTES:







- A. NO JEDEC REGISTRATION APPLIES.
- B. DIMENSIONS ARE IN MILLIMETERS.
- C. DIMENSIONS AND TOLERANCE PER ASMEY14.5M, 1994.
- D. DATUM C IS DEFINED BY THE SPHERICAL CROWNS OF THE BALLS.
- E. PACKAGE NOMINAL HEIGHT IS 582 MICRONS ±43 MICRONS (539-625 MICRONS).
- F. FOR DIMENSIONS D, E, X, AND Y SEE PRODUCT DATASHEET.
- G. BALL COMPOSITION: Sn95.5Ag3.9Cu0.6
- H. DRAWING FILNAME: MKT-UC006Aerev1.

Product	D	E	X	Y
FPF2024/5/6/7	1.500±/- 0.030	1.000 ±/-0.030	0.240	0.240



TRADEMARKS

The following includes registered and unregistered trademarks and service marks, owned by Fairchild Semiconductor and/or its global subsidiaries, and is not intended to be an exhaustive list of all such trademarks.

- | | | | |
|---|---|---|---|
| Build it Now™ | FRFET® | Programmable Active Droop™ | The Power Franchise® |
| CorePLUS™ | Global Power ResourceSM | QFET® | the power™ |
| CorePOWER™ | Green FPS™ | QS™ | franchise™ |
| CROSSVOLT™ | Green FPS™ e-Series™ | Quiet Series™ | TinyBoost™ |
| CTL™ | GTO™ | RapidConfigure™ | TinyBuck™ |
| Current Transfer Logic™ | IntelliMAX™ |  ™ | TinyLogic® |
| EcoSPARK® | ISOPLANAR™ | Saving our world, 1mW at a time™ | TINYOPTO™ |
| EfficientMax™ | MegaBuck™ | Saving our world, 1W at a time™ | TinyPower™ |
| EZSWITCH™ * | MICROCOUPLER™ | Saving our world, 1kW at a time™ | TinyPWM™ |
|  ™ | MicroFET™ | SmartMax™ | TinyWire™ |
|  ™ | MicroPak™ | SMART START™ | µSerDes™ |
| Fairchild® | MillerDrive™ | SPM® |  ™ |
| Fairchild Semiconductor® | MotionMax™ | STEALTH™ | UHC® |
| FACT Quiet Series™ | Motion-SPM™ | SuperFET™ | Ultra FRFET™ |
| FACT® | OPTOLOGIC® | SuperSOT™-3 | UniFET™ |
| FAST® | OPTOPLANAR® | SuperSOT™-6 | Vcx™ |
| FastvCore™ |  ™ | SuperSOT™-8 | VisualMax™ |
| FlashWriter® * | PDP SPM™ | SupreMOS™ | |
| FPS™ | Power-SPM™ | SyncFET™ | |
| F-PFS™ | PowerTrench® |  ™ | |

* EZSWITCH™ and FlashWriter® are trademarks of System General Corporation, used under license by Fairchild Semiconductor.

DISCLAIMER

FAIRCHILD SEMICONDUCTOR RESERVES THE RIGHT TO MAKE CHANGES WITHOUT FURTHER NOTICE TO ANY PRODUCTS HEREIN TO IMPROVE RELIABILITY, FUNCTION, OR DESIGN. FAIRCHILD DOES NOT ASSUME ANY LIABILITY ARISING OUT OF THE APPLICATION OR USE OF ANY PRODUCT OR CIRCUIT DESCRIBED HEREIN; NEITHER DOES IT CONVEY ANY LICENSE UNDER ITS PATENT RIGHTS, NOR THE RIGHTS OF OTHERS. THESE SPECIFICATIONS DO NOT EXPAND THE TERMS OF FAIRCHILD'S WORLDWIDE TERMS AND CONDITIONS, SPECIFICALLY THE WARRANTY THEREIN, WHICH COVERS THESE PRODUCTS.

LIFE SUPPORT POLICY

FAIRCHILD'S PRODUCTS ARE NOT AUTHORIZED FOR USE AS CRITICAL COMPONENTS IN LIFE SUPPORT DEVICES OR SYSTEMS WITHOUT THE EXPRESS WRITTEN APPROVAL OF FAIRCHILD SEMICONDUCTOR CORPORATION.

As used herein:

1. Life support devices or systems are devices or systems which, (a) are intended for surgical implant into the body or (b) support or sustain life, and (c) whose failure to perform when properly used in accordance with instructions for use provided in the labeling, can be reasonably expected to result in a significant injury of the user.
2. A critical component in any component of a life support, device, or system whose failure to perform can be reasonably expected to cause the failure of the life support device or system, or to affect its safety or effectiveness.

ANTI-COUNTERFEITING POLICY

Fairchild Semiconductor Corporation's Anti-Counterfeiting Policy. Fairchild's Anti-Counterfeiting Policy is also stated on our external website, www.fairchildsemi.com, under Sales Support.

Counterfeiting of semiconductor parts is a growing problem in the industry. All manufactures of semiconductor products are experiencing counterfeiting of their parts. Customers who inadvertently purchase counterfeit parts experience many problems such as loss of brand reputation, substandard performance, failed application, and increased cost of production and manufacturing delays. Fairchild is taking strong measures to protect ourselves and our customers from the proliferation of counterfeit parts. Fairchild strongly encourages customers to purchase Fairchild parts either directly from Fairchild or from Authorized Fairchild Distributors who are listed by country on our web page cited above. Products customers buy either from fairchild directly or from Authorized Fairchild Distributors are genuine parts, have full traceability, meet Fairchild's quality standards for handling and storage and provide access to Fairchild's full range of up-to-date technical and product information. Fairchild and our Authorized Distributors will stand behind all warranties and will appropriately address and warranty issues that may arise. Fairchild will not provide any warranty coverage or other assistance for parts bought from Unauthorized Sources. Fairchild is committed to combat this global problem and encourage our customers to do their part in stopping this practice by buying direct or from authorized distributors.

PRODUCT STATUS DEFINITIONS

Definition of Terms

Datasheet Identification	Product Status	Definition
Advance Information	Formative / In Design	Datasheet contains the design specifications for product development. Specifications may change in any manner without notice.
Preliminary	First Production	Datasheet contains preliminary data; supplementary data will be published at a later date. Fairchild Semiconductor reserves the right to make changes at any time without notice to improve design.
No Identification Needed	Full Production	Datasheet contains final specifications. Fairchild Semiconductor reserves the right to make changes at any time without notice to improve the design.
Obsolete	Not In Production	Datasheet contains specifications on a product that is discontinued by Fairchild Semiconductor. The datasheet is for reference information only.