

## 50 Gbps, AND / NAND / OR / NOR MODULE



### Typical Applications

The HMC-C065 is ideal for:

- OC-768 and SDH STM-256 Equipment
- Serial Data Transmission up to 50 Gbps
- Digital Logic Systems up to 50 Gbps
- Broadband Test and Measurement

### Functional Diagram

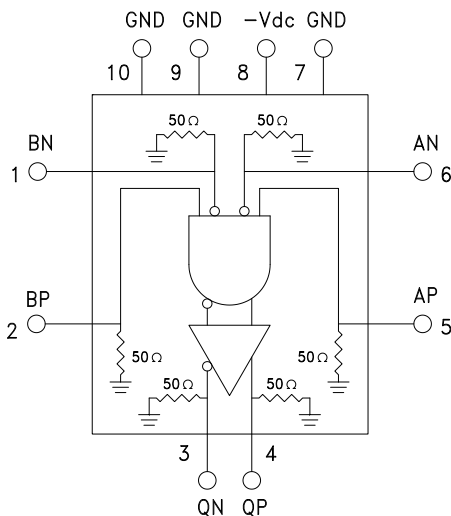

### Features

- Supports Data Rates up to 50 Gbps
- Inputs Terminated Internally in 50 ohms
- Supports Single-Ended or Differential Operation
- Low Power Consumption: 560mW
- Less Than 200 fs Additive RMS Jitter
- Single -3.3 V Power Supply
- Hermetically Sealed Module: 1.85mm Connectors
- 40°C to +70°C Operating Temperature

### General Description

The HMC-C065 is an AND/NAND/OR/NOR gate function designed to support data transmission rates of up to 50 Gbps. The HMC-C065 may be easily configured to provide any of the following logic functions: AND, NAND, OR and NOR. All input signals to the HMC-C065 are terminated with 50 Ohms to ground on-chip, and may be either AC or DC coupled. The differential outputs of the HMC-C065 may be either AC or DC coupled. Outputs can be connected directly to a 50 Ohm to ground terminated system, while DC blocking capacitors may be used if the terminating system is 50 Ohms to a non-ground DC voltage. The HMC-C065 operates from a single -3.3V DC supply, and is supplied in a hermetically sealed module with 1.85mm connectors.

### Electrical Specifications, $T_A = +25^\circ\text{C}$ , $-V_{dc} = V_{ee} = -3.3\text{V}$

Parameter	Conditions	Min.	Typ.	Max	Units
Power Supply Voltage	$\pm 10\%$ Tolerance	-3.6	-3.3	-3	V
Power Supply Current			170	210	mA
Maximum Data Rate	NRZ Format	50			Gbps
Maximum Clock Rate		25			GHz
Deterministic Jitter [1]			2		ps p-p
Additive Random Jitter [2]			0.2		ps rms
Rise Time, tr	20% - 80%		9		ps
Fall Time, tf	20% - 80%		10		ps
Data Output Swing	Differential Output Swing	400	480		mV p-p
Input Return Loss	Up to 28 GHz		10		dB

For price, delivery, and to place orders, please contact Hittite Microwave Corporation:  
20 Alpha Road Chelmsford, MA 01824 Phone: 978-250-3343 Fax: 978-250-3373

Order Online at [www.hittite.com](http://www.hittite.com)  
**www.BDTIC.com/Hittite/**

**50 Gbps, AND / NAND / OR / NOR  
MODULE**

**Electrical Specifications, (continued)**

Parameter	Conditions	Min.	Typ.	Max	Units
Output Return Loss	up to 28 GHz		10		dB
Propagation Delay, td			230		ps
Data Input Amplitude	Single-Ended Amplitude	100		800	mV p-p
	Differential Amplitude	100		2000	mV p-p
Input High Voltage		-0.5		0.5	V
Input Low Voltage		-1		0	V
Output High Voltage			-10		mV
Output Low Voltage			-300		mV

[1] Deterministic jitter measured at 45 Gbps with PRBS 2<sup>13</sup>-1 pattern. It is the peak to peak deviation from the ideal time crossing  
 [2] Random jitter is measured with 45 Gbps 10101... pattern

**DC Current vs. Supply Voltage**

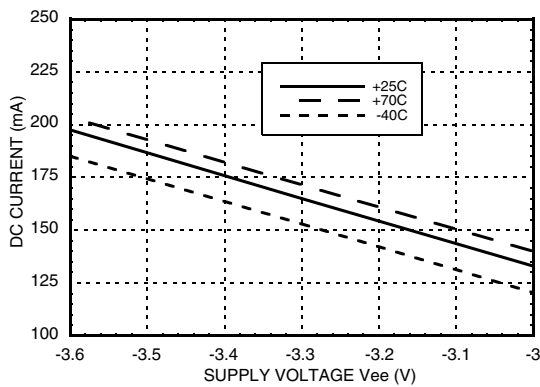

**Differential Output vs. Supply Voltage**

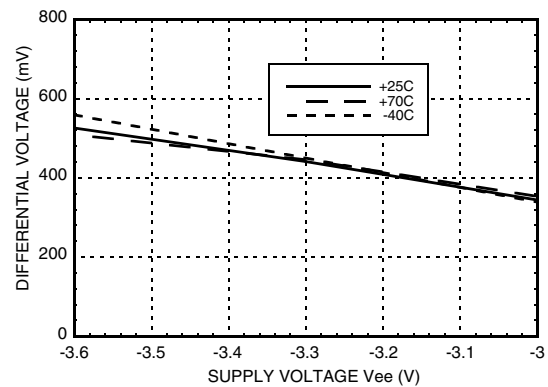

**Output Power vs. Frequency**

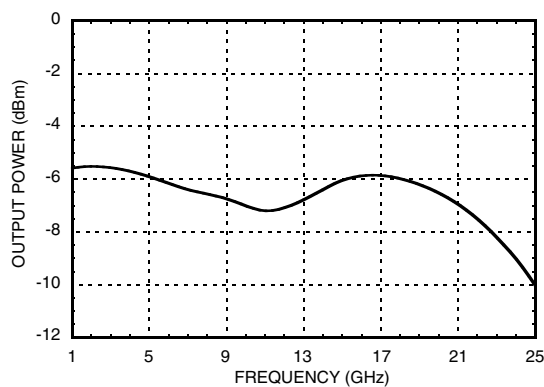

For price, delivery, and to place orders, please contact Hittite Microwave Corporation:  
 20 Alpha Road Chelmsford, MA 01824 Phone: 978-250-3343 Fax: 978-250-3373

[www.BDTIC.com/Hittite/](http://www.BDTIC.com/Hittite/)

**50 Gbps, AND / NAND / OR / NOR  
MODULE**

**Peak-to-Peak Jitter vs. Supply Voltage [1] [2]**

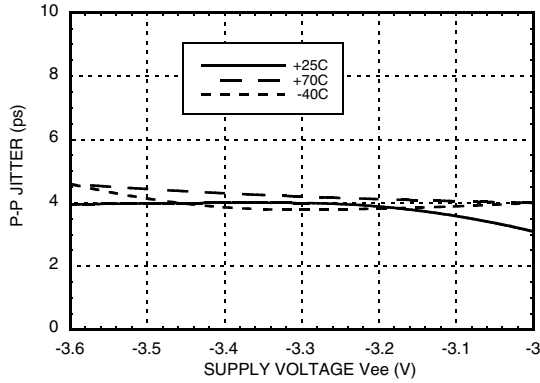

**Rise Time vs. Supply Voltage [1]**

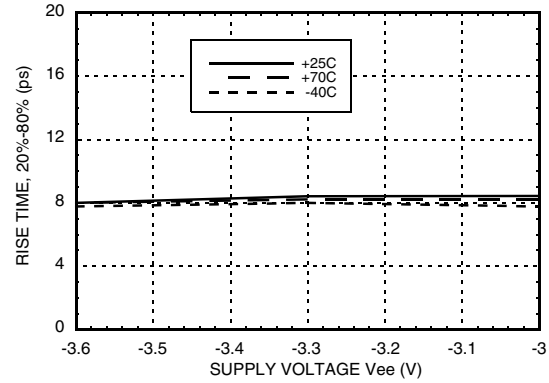

**Fall Time vs. Supply Voltage [1]**

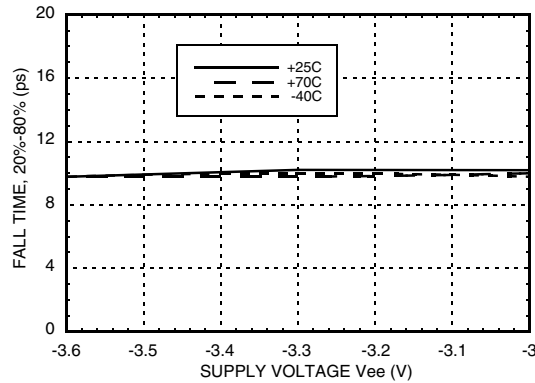

[1] Data input = 45Gbps PRBS 2<sup>23</sup>-1

[2] Source jitter was not deembedded.

For price, delivery, and to place orders, please contact Hittite Microwave Corporation:  
20 Alpha Road Chelmsford, MA 01824 Phone: 978-250-3343 Fax: 978-250-3373

Order Online at [www.hittite.com](http://www.hittite.com)  
**www.BDTIC.com/Hittite/**

## 50 Gbps, AND / NAND / OR / NOR MODULE

### Eye Diagram

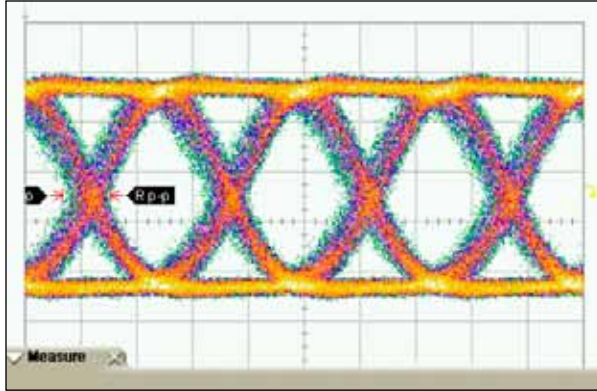

[1] Test Conditions:

Eye diagram data presented on an Infinium DCA 86100A

Rate = 40 GB/s

Pseudo Random Code =  $2^{23}-1$

Vin = 250 mVpp Differential

	Current	Minimum	Maximum	Total Meas
Rise Time (f1)	11.56 ps	10.89 ps	11.78 ps	20
Fall Time (f1)	10.89 ps	10.22 ps	10.89 ps	20
Differential Eye Amplitude (f1)	490 mV	489 mV	490 mV	20
Jitter p-p (f1)	8.667 ps	8.000 ps	8.89 ps	20

Vertical Scale	122.8 mV / div
Horizontal Scale	10.0 ps / div

### Timing Diagram

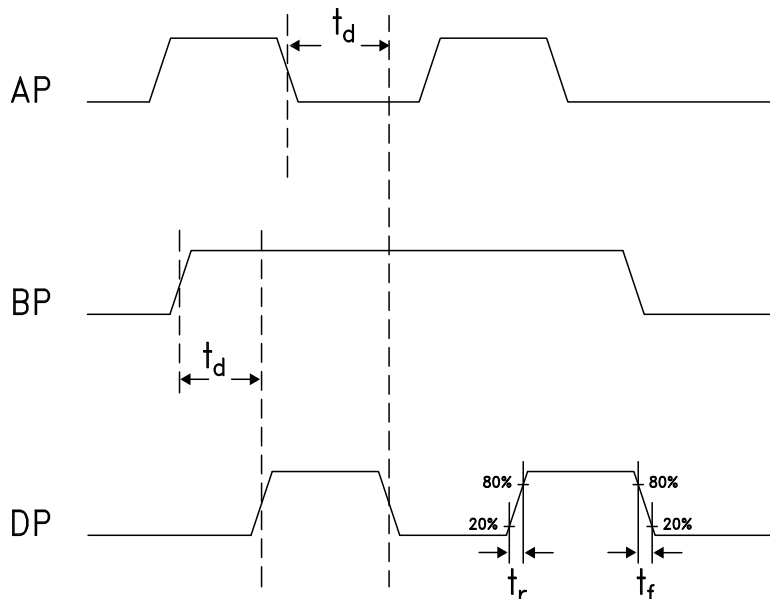

### Truth Table

Input		Outputs
A	B	Q
L	L	L
L	H	L
H	L	L
H	H	H

Notes:  
A = AP - AN  
B = BP - BN  
Q = QP - QN

H - Negative voltage level  
L - Positive voltage level

For price, delivery, and to place orders, please contact Hittite Microwave Corporation:  
20 Alpha Road Chelmsford, MA 01824 Phone: 978-250-3343 Fax: 978-250-3373

Order Online at [www.hittite.com](http://www.hittite.com)  
[www.BDTIC.com/Hittite/](http://www.BDTIC.com/Hittite/)

**50 Gbps, AND / NAND / OR / NOR  
MODULE**

**Absolute Maximum Ratings**

Power Supply Voltage (Vee)	-3.6 to +0.5V
Input Signals	-1.5V to +0.5V
Output Signals	-1.5V to +0.5V
Junction Temperature	125°C
Storage Temperature	-65°C to +125°C
Operating Temperature	-40°C to 70°C



**ELECTROSTATIC SENSITIVE DEVICE  
OBSERVE HANDLING PRECAUTIONS**

**Outline Drawing**

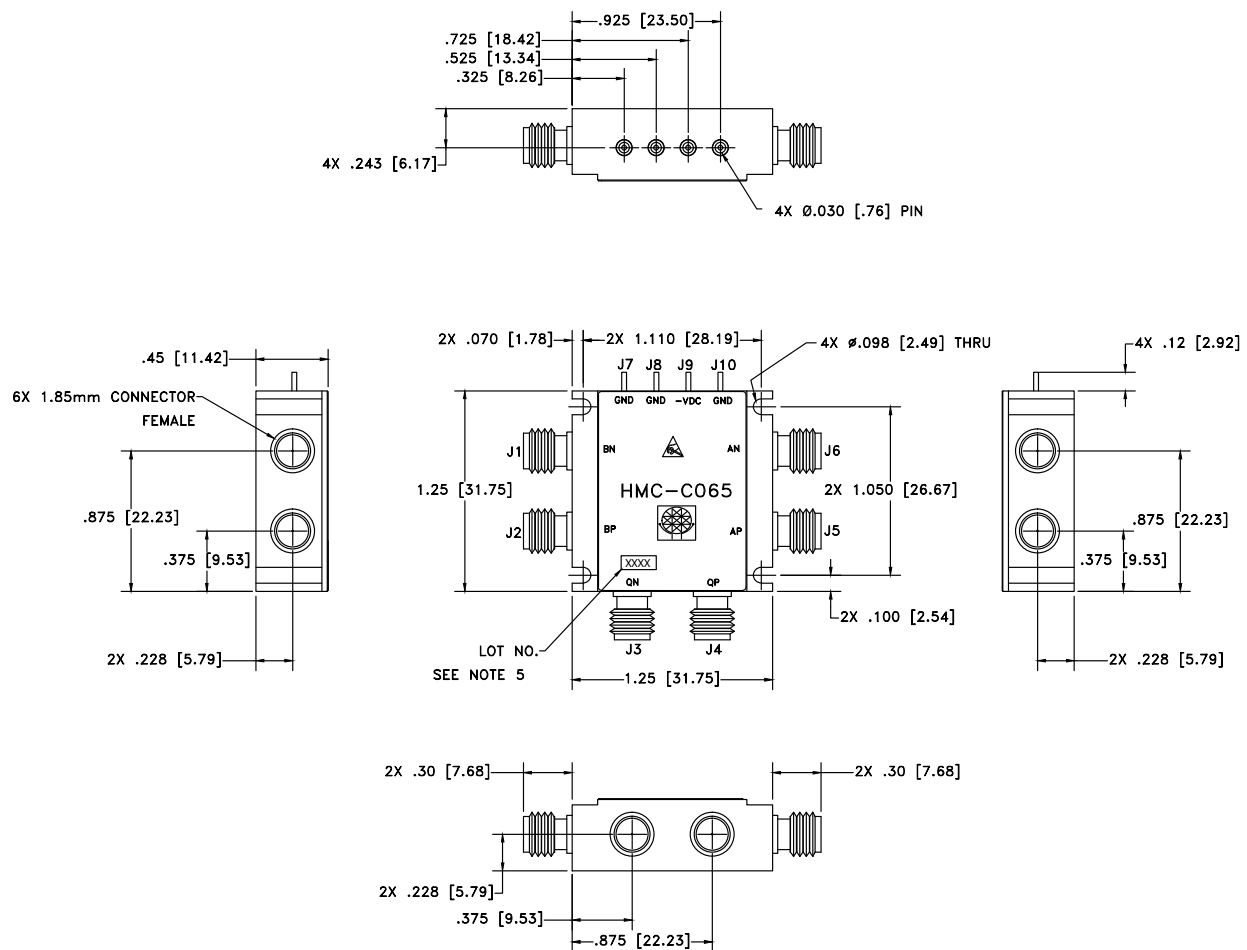

**NOTES:**

- 1 PACKAGE, LEADS, COVER MATERIAL: KOVAR
- 2 FINISH: GOLD PLATE OVER NICKEL PLATE.
- 3 ALL DIMENSIONS ARE IN INCHES [MILLIMETERS]
- 4 TOLERANCES:  
4.1 .XX = ± .02  
4.2 XXX = ± .010
- 5 MARK LOT NUMBER ON 0.080 X 0.250 LABEL WHERE SHOWN, WITH 0.030" MIN. TEXT HEIGHT.

**Package Information**



Package Type	C-13
Package Weight [1]	59.5 gms

[1] Includes the connectors

[2] ±1 gms Tolerance

**50 Gbps, AND / NAND / OR / NOR  
MODULE**

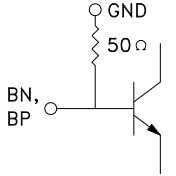
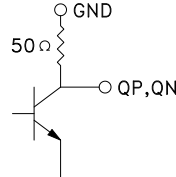
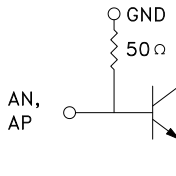
**Pin Descriptions**

Pin Number	Function	Description	Interface Schematic
1, 2	BN, BP	Differential Data Input B.	
3, 4	QN, QP	Differential data outputs.	
5, 6	AP, AN	Differential Data Input A.	
7, 9, 10	GND	Signal and supply ground.	
8	-Vdc	-3.3V Negative Supply	