



## WIDEBAND DIRECT QUADRATURE MODULATOR, 100 - 6000 MHz

### Typical Applications

The HMC1097LP4E is Ideal for:

- UMTS, GSM or CDMA Basestations
- Fixed Wireless or WLL
- ISM Transceivers, 900 & 2400 MHz
- GMSK, QPSK, QAM, SSB Modulators
- Cellular/3G and WiMAX/4G

### Features

- Very Low Noise Floor, -160 dBm/Hz
- Excellent Carrier & Sideband Suppression
- Very High Linearity, +30 dBm OIP3
- High Output Power, +11 dBm Output P1dB
- High Modulation Accuracy
- 24 Lead 4x4 mm QFN Package: 16 mm<sup>2</sup>

### Functional Diagram

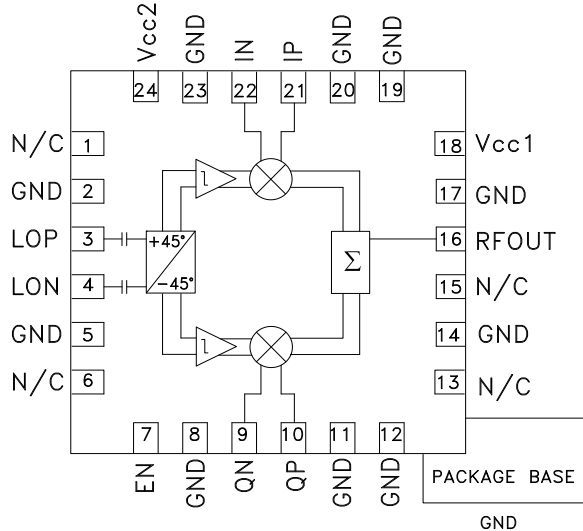

### General Description

The HMC1097LP4E is a low noise, high linearity Direct Quadrature Modulator RFIC which is ideal for digital modulation applications from 0.1 to 6.0 GHz including; Cellular/3G, WiMAX/4G, Broadband Wireless Access & ISM circuits. Housed in a compact 4x4 mm (LP4) SMT QFN package, the RFIC requires minimal external components & provides a low cost alternative to more complicated double upconversion architectures. The RF output port is single-ended and matched to 50 Ohms with no external components. The LO requires -6 to +6 dBm and can be driven in either differential or single-ended mode. This device is optimized for a +5V supply, and offers improved carrier feedthrough and sideband suppression characteristics.

### Electrical Specifications, See Test Conditions on following page herein.

Parameter	Typ.	Typ.	Typ.	Typ.	Typ.	Units
Frequency Range, RF	450-960	1700-2200	2200-2700	3400-4000	5000-6000	MHz
Output Power	1.5	2.7	2.7	0	-5.2	dBm
Conversion Voltage Gain	-4.7	-3.5	-3.5	-6.2	-11.4	dB
Output P1dB	+11	+11	+10.5	+10	+5.3	dBm
Output Noise Floor	-162	-160	-159	-159	-156	dBm/Hz
Output IP3	+29	+31	+29	+22	+17	dBm
Carrier Feedthrough (uncalibrated)	-40	-39	-36	-29	-33	dBm
Sideband Suppression (uncalibrated)	40	46	48	32	29	dBc
LO Port Return Loss	4	6	6	6	6	dB
RF Port Return Loss	12	14	15	16	16	dB

For price, delivery and to place orders: Hittite Microwave Corporation, 2 Elizabeth Drive, Chelmsford, MA 01824

Phone: 978-250-3343 Fax: 978-250-3373 Order On-line at [www.hittite.com](http://www.hittite.com)

Application Support: Phone: 978-250-3343 or [apps@hittite.com](mailto:apps@hittite.com)

## WIDEBAND DIRECT QUADRATURE MODULATOR, 100 - 6000 MHz

### Electrical Specifications, (continued)

Parameter	Conditions	Min.	Typ.	Max.	Units
<b>RF Output</b>					
RF Frequency Range		100		6000	MHz
RF Return Loss			15		dB
<b>LO Input</b>					
LO Frequency Range		100		6000	MHz
LO Input Power		-6	0	+6	dBm
LO Port Return Loss			6		dB
<b>Baseband Input Port</b>					
Baseband Input DC Voltage (Vbbdc)			+0.45 (+0.4--+0.5)		V
Baseband Input DC Bias Current (Ibbdc)	Single-ended.		110		pA
Single-ended Baseband Input Capacitance	De-embed to the lead of the device.		4.5		pF
<b>DC Power Supply</b>					
Supply Voltage (Vcc1, Vcc2)		+4.75	+5.0	+5.25	V
Supply Current (Icc1 + Icc2) EN Low			170		mA
Supply Current (Icc1 + Icc2) EN High			8		mA
<b>Enable/Disable Interface</b>					
EN High Level	Device disabled	2.2	5		V
EN Low Level	Device enabled		0	1.5	V
Enable/Disable Settling Time			400/400		ns
LO Leakage Isolation	EN=5V, LO=2.1GHz, 0dBm		-57.1		dBm

### Test Conditions: Unless Otherwise Specified, the Following Test Conditions Were Used

Parameter	Condition
Temperature	+25 °C
Baseband Input Frequency	200 kHz
Baseband Input DC Voltage (Vbbdc)	+0.45V
Baseband Input AC Voltage (Peak to Peak Differential, I and Q)	1.3V
Baseband Input AC Voltage for OIP3 Measurements (Peak to Peak Differential, I and Q)	650 mV per tone @ 3.5 & 4.5 MHz
Baseband Input AC Voltage for Noise Floor Measurements (Peak to Peak Differential, I and Q)	no baseband input voltage
Frequency Offset for Output Noise Measurements	20 MHz
Supply (Vcc1, Vcc2)	+5.0V
LO Input Power	0 dBm
LO Input Mode	Single-Ended through LON
Mounting Configuration	Refer to HMC1097LP4E Application Schematic Herein
Sideband & Carrier Feedthrough	Uncalibrated

### Calibrated vs. Uncalibrated Test Results

During the Uncalibrated Sideband and Carrier Suppression tests, care is taken to ensure that the I/Q signal paths from the Vector Signal Generator (VSG) to the Device Under Test (DUT) are equal. The "Uncalibrated" Sideband and Carrier Suppression plots were measured at T= -40 °C, +25 °C, and +85 °C.

The "Calibrated" Sideband Suppression data was plotted after a manual adjustment of the I/Q amplitude balance and I/Q phase offset (skew) at +25 °C, 5V Vcc, 0 dBm LO input power level. The +25 °C adjustment settings were held constant during tests over temperature.

The "Calibrated" Carrier Suppression data was plotted after a manual adjustment of the IP/IN & QP/QN DC offsets at +25 °C, 5V Vcc, 0 dBm LO input power level. The +25 °C adjustment settings were held constant during tests over temperature.

## WIDEBAND DIRECT QUADRATURE MODULATOR, 100 - 6000 MHz

**Output Power vs. Frequency Over Temperature**

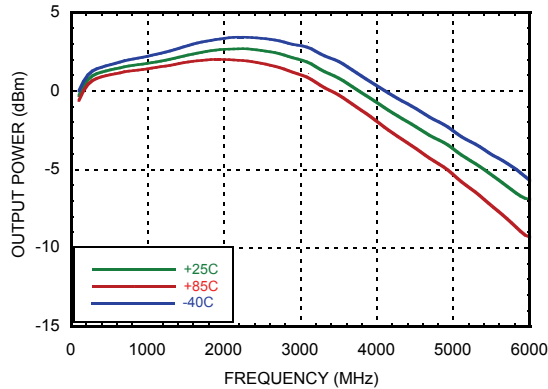

**Output IP3, P1dB & Noise Floor @ 20 MHz Offset vs. Frequency Over Temperature**

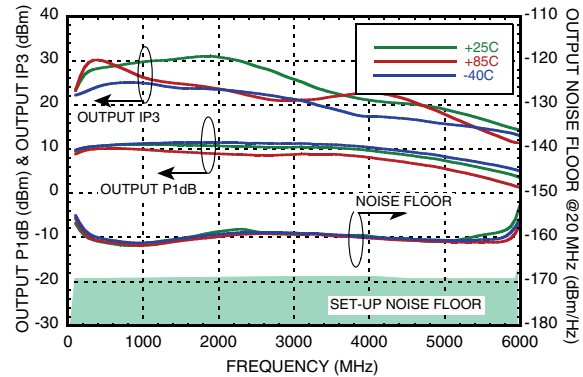

**Uncalibrated Carrier Feedthrough [1] vs. Frequency Over Temperature**

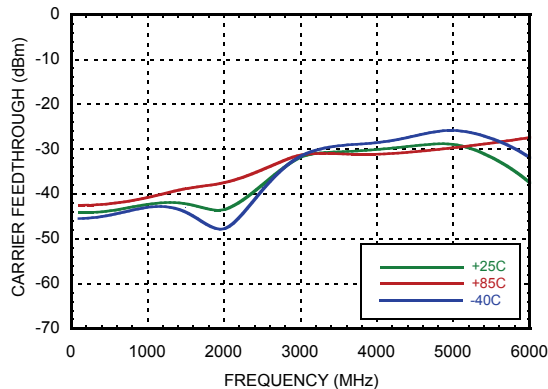

**Calibrated Carrier Feedthrough [1] vs. Frequency Over Temperature**

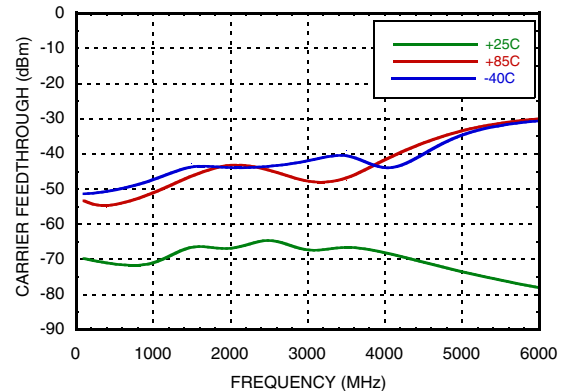

**Uncalibrated Carrier Feedthrough [1] vs. Frequency Over Temperature When Disabled**

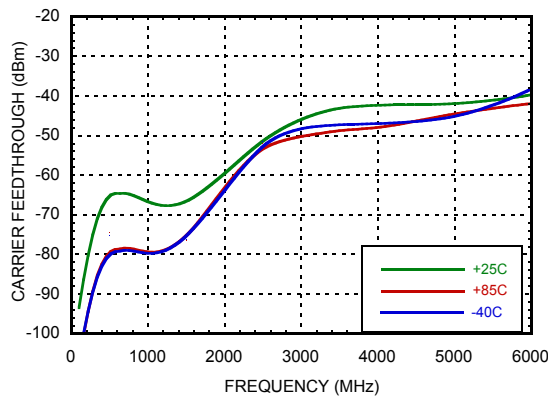

**RF and LO Return Loss vs. Frequency**

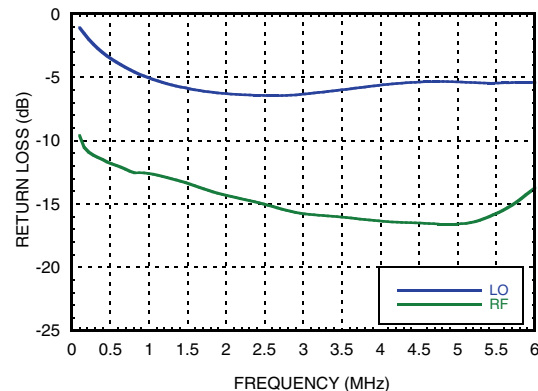

[1] See note titled "Calibrated vs. Uncalibrated test results" herein.

## WIDEBAND DIRECT QUADRATURE MODULATOR, 100 - 6000 MHz

**Output Power vs. Frequency Over LO Power**

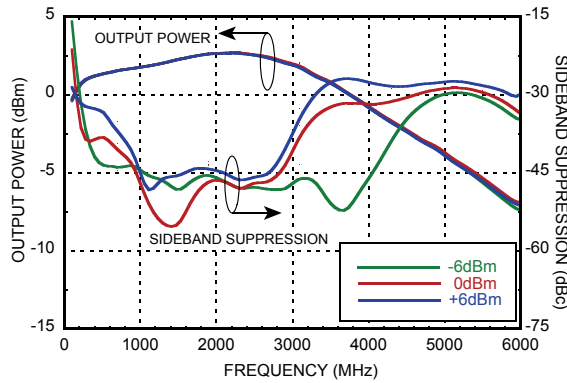

**Output IP3, P1dB & Noise Floor @ 20 MHz Offset vs. Frequency Over LO Power**

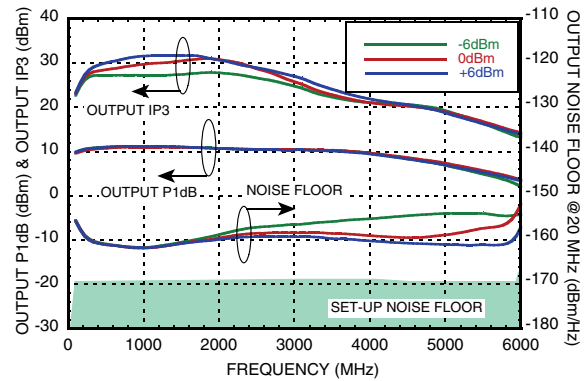

**Uncalibrated Sideband Suppression vs. Frequency Over Temperature [1]**

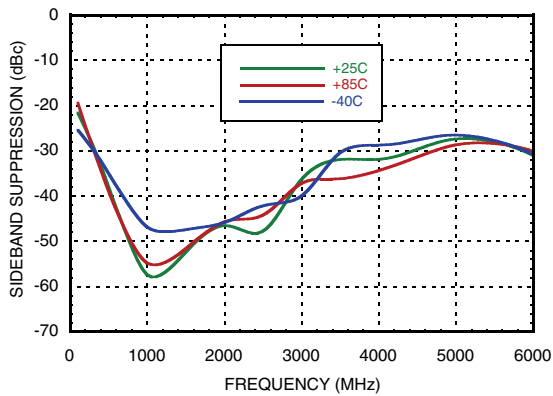

**Calibrated Sideband Suppression vs. Frequency Over Temperature [1]**

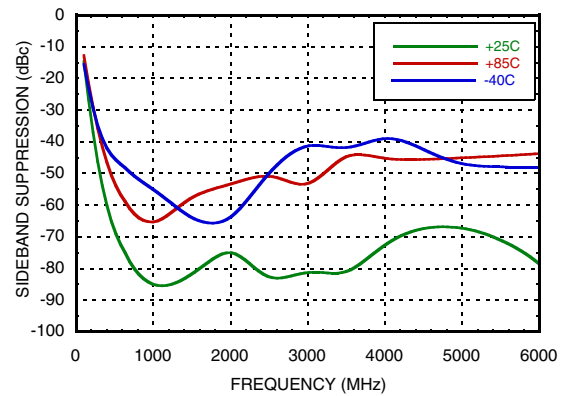

**Output Power vs. Frequency Over Supply Voltage**

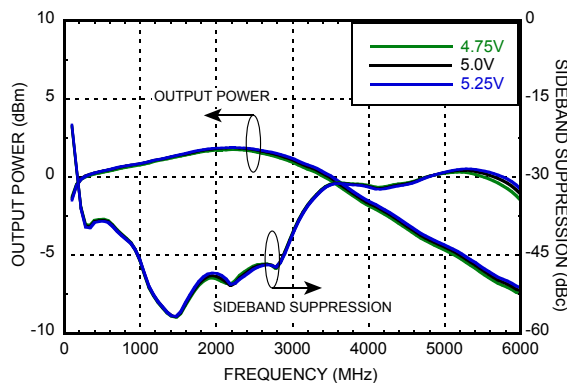

**Output IP3, P1dB & Noise Floor @ 20 MHz Offset vs. Frequency Over Supply Voltage**

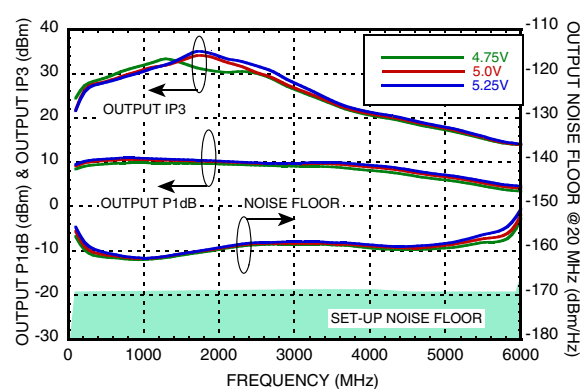

[1] See note titled "Calibrated vs. Uncalibrated test results" herein.



## WIDEBAND DIRECT QUADRATURE MODULATOR, 100 - 6000 MHz

**Output Power vs. Baseband Voltage @ 2100 MHz**

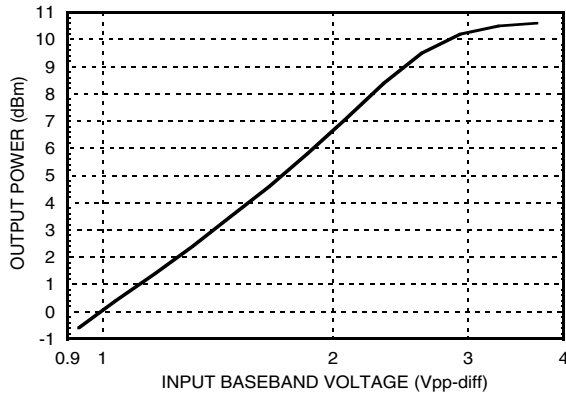

**Output Noise @ 20 MHz Offset vs. Output Power Over LO Frequency**

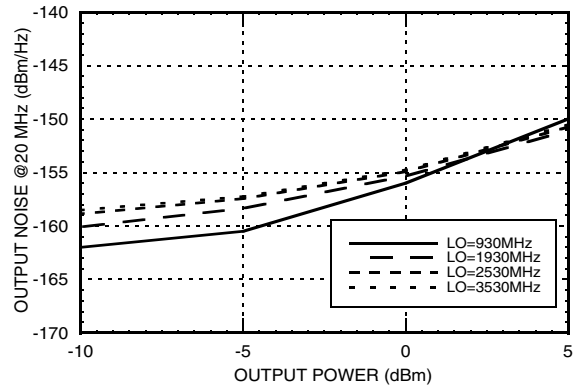

**ACPR for W-CDMA @ 2140 MHz, 1 Carrier<sup>[1]</sup>**

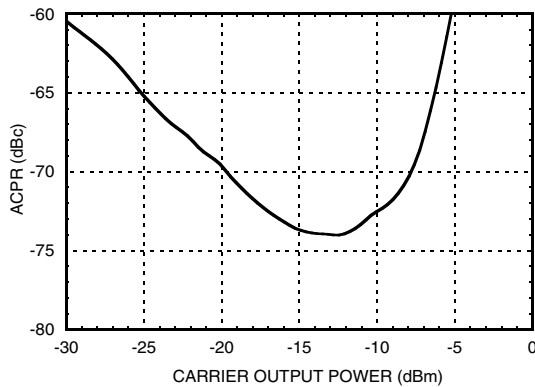

[1] W-CDMA (Modulation Set-up for ACPR Mode); The Baseband I and Q input signals were generated using "Test Model 1 with 64 channels" settings in the Agilent E3844C.

### Absolute Maximum Ratings

Vcc1, Vcc2, EN	0V to +5.6V
LO Input Power	+18 dBm
Baseband Input Voltage (AC + DC) (Reference to GND)	-0.3V to + 1.3V
Junction Temperature	125°C
Continuous Pdiss (T = 85°C) (Derate 30 mW/°C above 85°C)	2.05 Watts
Thermal Resistance (R <sub>th</sub> ) (junction to ground paddle)	9°C/W
Storage Temperature	-65 to +150 °C
Operating Temperature	-40 to +85 °C
ESD Sensitivity (HBM)	Class 1B



ELECTROSTATIC SENSITIVE DEVICE  
OBSERVE HANDLING PRECAUTIONS

### Outline Drawing

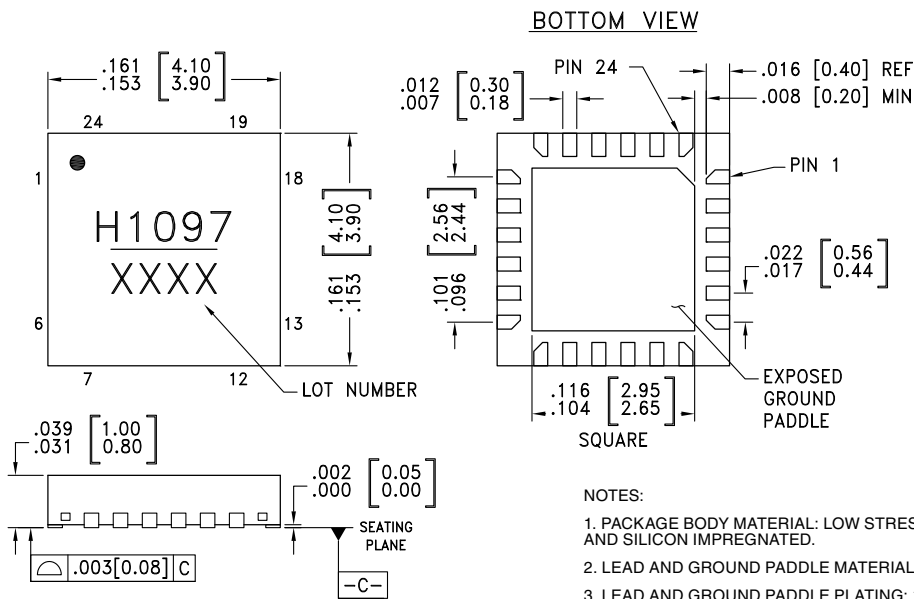

#### NOTES:

1. PACKAGE BODY MATERIAL: LOW STRESS INJECTION MOLDED PLASTIC SILICA AND SILICON IMPREGNATED.
2. LEAD AND GROUND PADDLE MATERIAL: COPPER ALLOY.
3. LEAD AND GROUND PADDLE PLATING: 100% MATTE TIN.
4. DIMENSIONS ARE IN INCHES [MILLIMETERS].
5. LEAD SPACING TOLERANCE IS NON-CUMULATIVE.
6. CHARACTERS TO BE HELVETICA MEDIUM, .025 HIGH, WHITE INK, OR LASER MARK LOCATED APPROX. AS SHOWN.
7. PAD BURR LENGTH SHALL BE 0.15mm MAX. PAD BURR HEIGHT SHALL BE 0.25mm MAX.
8. PACKAGE WARP SHALL NOT EXCEED 0.05mm
9. ALL GROUND LEADS AND GROUND PADDLE MUST BE SOLDERED TO PCB RF GROUND.
10. REFER TO HITTITE APPLICATION NOTE FOR SUGGESTED PCB LAND PATTERN.

### Package Information

Part Number	Package Body Material	Lead Finish	MSL Rating	Package Marking [2]
HMC1097LP4E	RoHS-compliant Low Stress Injection Molded Plastic	100% matte Sn	MSL1 [1]	H1097 XXXX

[1] Max peak reflow temperature of 260 °C

[2] 4-Digit lot number XXXX

For price, delivery and to place orders: Hittite Microwave Corporation, 2 Elizabeth Drive, Chelmsford, MA 01824

Phone: 978-250-3343 Fax: 978-250-3373 Order On-line at [www.hittite.com](http://www.hittite.com)

Application Support: Phone: 978-250-3343 or [apps@hittite.com](mailto:apps@hittite.com)

### Pin Descriptions

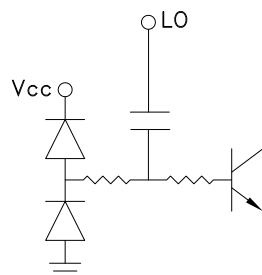
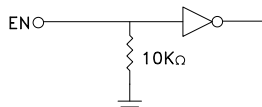
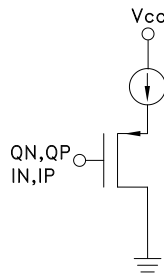
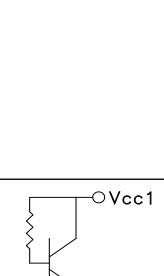
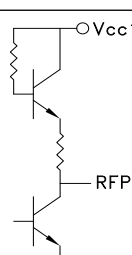
Pin Number	Function	Description	Interface Schematic
1, 6, 13, 15	N/C	Not connected.	
2, 5, 8, 11, 12, 14, 17, 19, 20, 23	GND	These pins and the ground paddle should be connected to a high quality RF/DC ground.	
3, 4	LOP, LON	LO inputs. AC coupled and matched to 50 Ohms single ended. Do not need external DC decoupling capacitors. The ports could be driven single-ended or differentially.	
7	EN	This pin has a 10 Kohm pulldown resistor to GND. When connected to GND or left floating the chip is fully enabled. When connected to VCC the LO amplifiers and the mixers are disabled.	
9, 10	QN, QP	Q channel differential baseband input. These are high impedance ports. The nominal recommended bias voltage is 0.45V (0.4V-0.5V) <sup>[1]</sup> . The nominal recommended baseband input AC voltage is 1.3V peak-to-peak differential. By adjusting the DC offsets on ports QN & QP, the Carrier Suppression of the device can be optimized for a specific frequency band and LO power level. The typical offset voltage for optimization is less than 15 mV.  The amplitude and phase difference between The I and Q inputs can be adjusted in order to optimize the Sideband Suppression for a specific frequency band and LO power level	
21, 22	IP, IN	I channel differential baseband input. These are high impedance ports. The nominal recommended bias voltage is 0.45V (0.4V-0.5V) <sup>[1]</sup> . The nominal recommended baseband input AC voltage is 1.3V peak-to-peak differential. By adjusting the DC offsets on ports IN & IP, the Carrier Suppression of the device can be optimized for a specific frequency band and LO power level. The typical offset voltage for optimization is less than 15 mV.  The amplitude and phase difference between The I and Q inputs can be adjusted in order to optimize the Sideband Suppression for a specific frequency band and LO power level	
16	RFOUT	DC coupled and matched to 50 Ohms. Output requires an external DC blocking capacitor.	

[1] See Linearity Optimization in the Application Information Section.

### Pin Descriptions (continued)

Pin Number	Function	Description	Interface Schematic
18	Vcc1	Supply voltage for the output stages 30 mA @ +5V.	
24	Vcc2	Supply voltage for the LO and mixer stage 140 mA @ +5V.	

### Application & Evaluation PCB Schematic

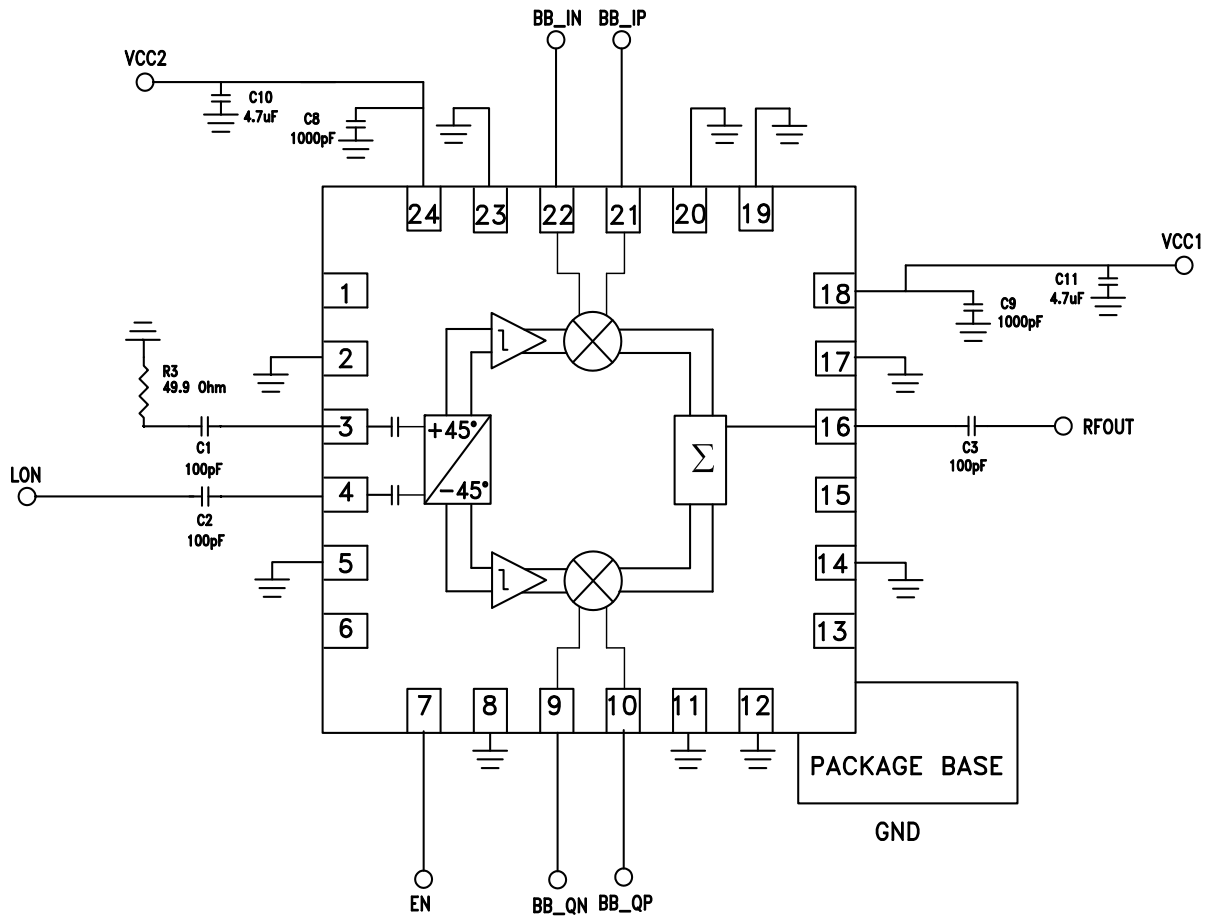



### Evaluation PCB

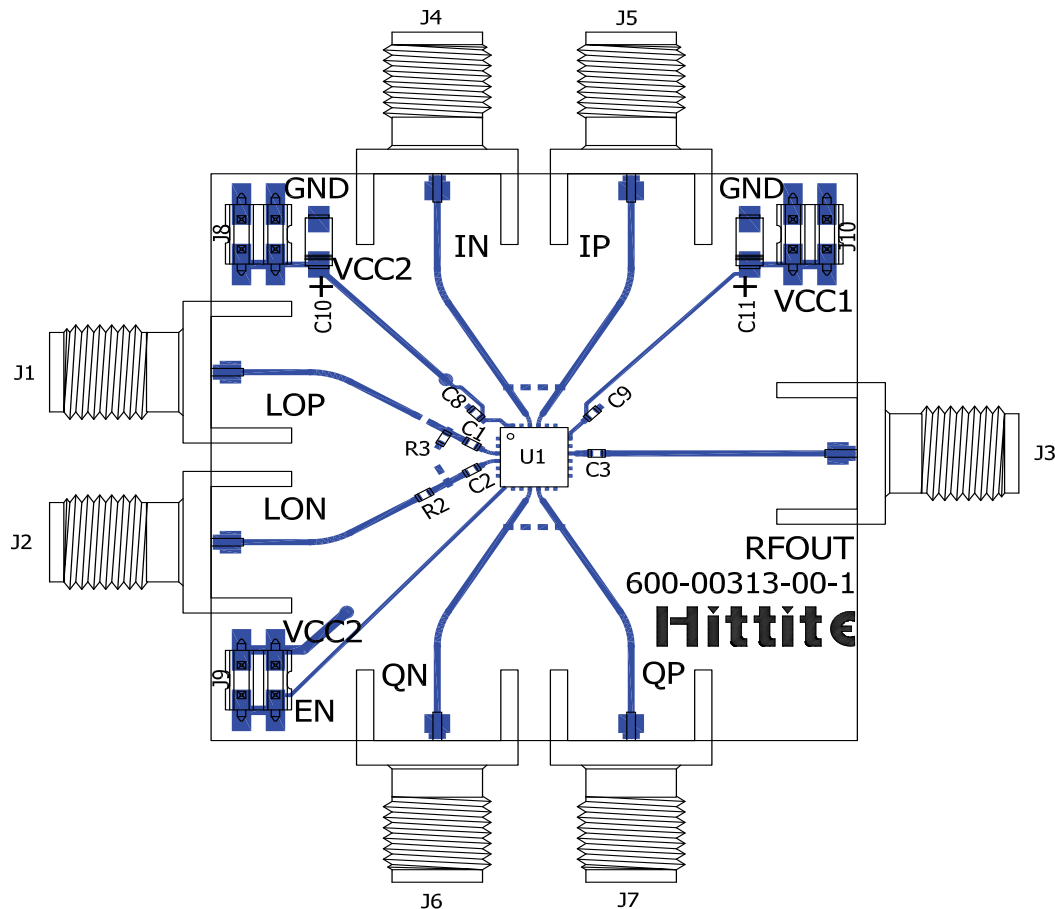

### List of Materials for Evaluation PCB EVAL01-HMC1097LP4E<sup>[1]</sup>

Item	Description
J1 - J7	PC Mount SMA Connector
J8-J10	DC Molex Connector
C1 - C3	100 pF Chip Capacitor, 0402 Pkg.
C8, C9	1000 pF Chip Capacitor, 0402 Pkg.
C10, C11	4.7 uF, Case A, Tantalum
R2	0 Ohm Resistor, 0402 Pkg.
R3	49.9 Ohm Resistor, 0402 Pkg.
U1	HMC1097LP4E Modulator
PCB <sup>[2]</sup>	600-00313-00-1 Evaluation PCB

[1] Reference this number when ordering complete evaluation PCB

[2] Circuit Board Material: Rogers 4350

The circuit board used in the application should use RF circuit design techniques. Signal lines should have 50 ohm impedance while the package ground leads and exposed paddle should be connected directly to the ground plane similar to that shown. A sufficient number of via holes should be used to connect the top and bottom ground planes. The evaluation circuit board shown is available from Hittite upon request.

### Characterization Set-up

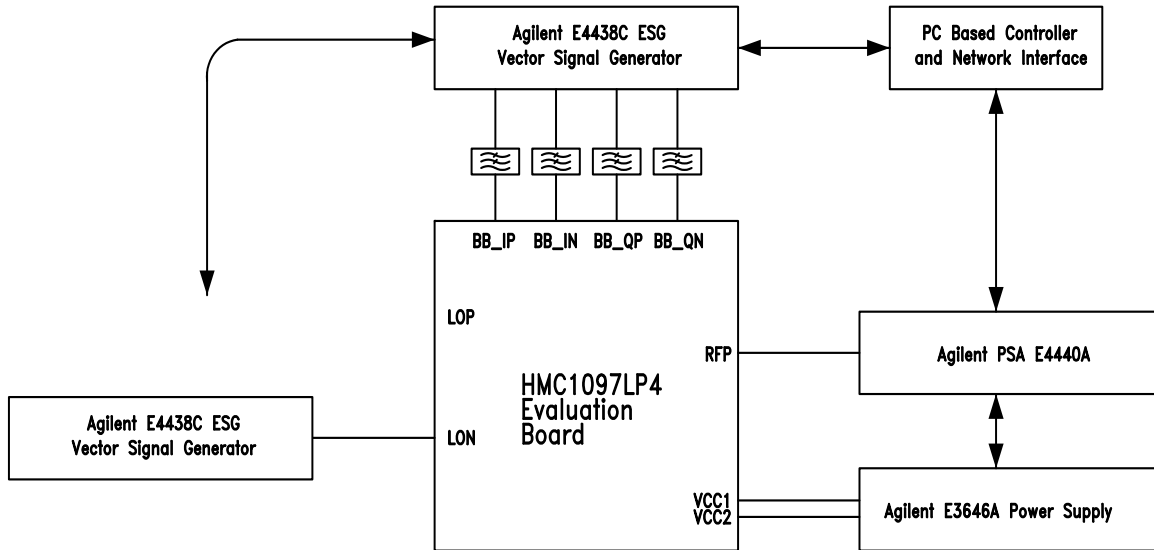

### Application Information

#### Principle of Operation

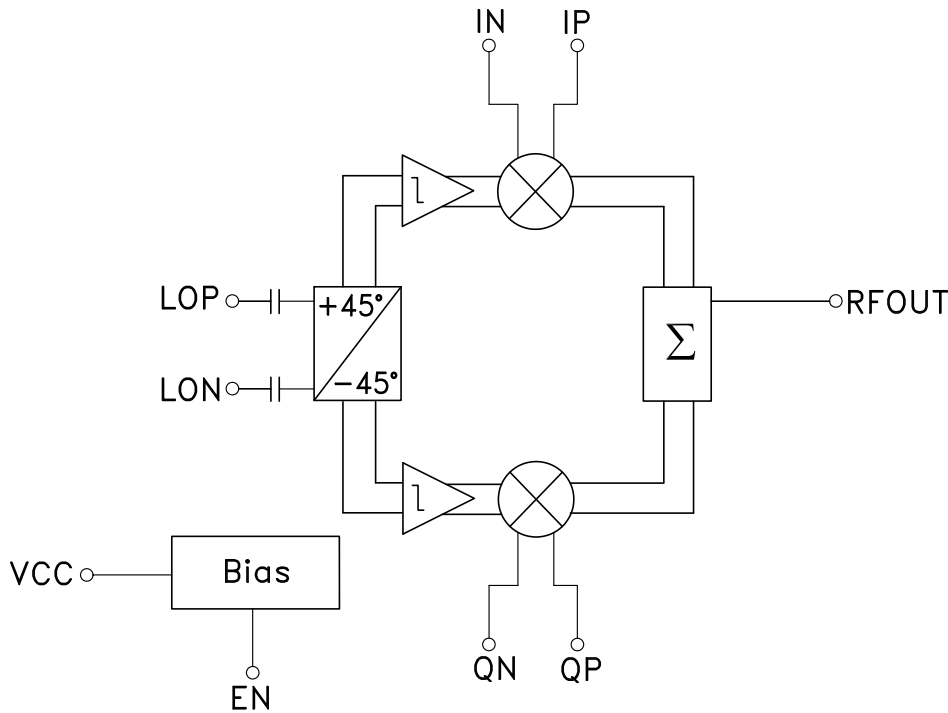

Figure 1: The HMC1097LP4E Simplified Block Diagram

The HMC1097LP4E is a low-noise, high-linearity, broadband Direct Quadrature Modulator designed for directly converting complex modulated baseband signals from zero IF or low IF to RF transmission levels from 100 MHz to 6 GHz. The HMC1097LP4E's excellent noise and linearity performance makes it suitable for a wide range of transmission standards, including single and multicarrier CDMA, UMTS, CDMA2000, GSM/EDGE, W-CDMA, TD-SCDMA, and WiMAX/LTE applications.

As shown in the simplified block diagram (Figure 1) the HMC1097LP4E offers an easy-to-use, complete direct conversion solution in a highly compact 4 x 4 mm plastic package thereby reducing cost, area, and power consumption.

The HMC1097LP4E modulator consists of the following functional blocks:

1. LO Interface: High Accuracy LO quadrature phase splitter and LO limiting amplifiers
2. I/Q modulator: I and Q input differential voltage-to-current converters, I and Q upconverting mixers and the differential-to-single-ended converter
3. Bias and Enable/Disable Circuits

#### LO Interface

The LO interface consists of a LO quadrature phase splitter that generates two carrier signals in quadrature followed by LO limiting amplifiers which are used to drive the I and Q mixers with saturated signal levels. Therefore, the LO path is immune to large variations in the LO input signal level and the modulator performance does not vary much

## WIDEBAND DIRECT QUADRATURE MODULATOR, 100 - 6000 MHz

with LO input power.

The LO input impedance is set by the LO quadrature phase splitter. The LO port can be driven differentially with 100  $\Omega$  differential input impedance or single ended through LON input with 50 $\Omega$  input impedance while the unused LOP input should be terminated to GND through 50 $\Omega$ . The LO port requires -6 to +6 dBm input power in either differential or single-ended mode and does not require DC blocking capacitors.

### I/Q Modulator

The differential baseband inputs (QP, QN, IP, and IN) present a high impedance. The DC common-mode voltage at the baseband inputs sets the currents in the I and Q double-balanced mixers. The nominal baseband input DC common-mode voltage used in the characterization of the HMC1097LP4E is 0.45V, which should be externally applied. The baseband input DC common-mode voltage can be varied between 0.4V and 0.5V to optimize overall modulator performance. It is not recommended to leave the baseband inputs floating which generates excessive current flow that may cause damage to the IC. The baseband inputs should be pulled down to GND in shutdown mode. The nominal baseband input AC Voltage used in the characterization of the HMC1097LP4E is 1.3Vpp differential. The baseband input AC voltage can be varied to optimize overall modulator performance.

It is recommended to drive the baseband inputs differentially to reduce even-order distortion products and also use reconstruction filters at the baseband inputs to avoid aliasing

After upconversion, the outputs of the I and Q mixers are summed together differentially and converted to single-ended RF output. The single-ended RF output port is internally matched to 50 Ohms and does not require any external matching components. Only a standard DC-blocking capacitor is required at this interface.

### Bias and Enable/Disable Circuits

A bandgap reference circuit generates the reference currents used by the different sections. The part requires a single supply voltage of +5V to operate.

The EN pin can be used to disable the bandgap reference circuit. Disabling the bias circuit will also disable the reference currents to the LO limiting amplifiers, I and Q mixers and the output stage. If the EN pin is connected to ground or left floating, the part operates normally. If the EN pin is connected to the +5V VCC, the LO limiting amplifiers, I and Q mixers and the output stage are disabled and the LO leakage is also reduced. The LO signal itself is suppressed approximately by 57.1 dB at 2.1GHz when the EN pin is connected to the +5V VCC. The enable and disable settling times are approximately 400 ns.

### Carrier Feedthrough Calibration

Carrier feedthrough is related to the dc offsets at the differential baseband inputs of the modulator. If exactly the same DC common-mode voltage is applied to each of the baseband inputs and there were no dc offsets at the differential baseband inputs, the LO leakage at the RF output would be perfectly suppressed.

By adding small DC offset voltages at the differential baseband inputs, the carrier feedthrough can be optimized for a specific frequency band and LO power level. The carrier feedthrough can not be calibrated by the DC common-mode level at the I and Q baseband inputs. DC offsets at the differential I and Q baseband inputs should be iteratively adjusted until a minimum carrier feedthrough level is obtained. Externally available offset voltage steps and the modulator's noise floor limit the minimum achievable calibrated carrier feedthrough level. The typical offset voltages for optimization are less than 15mV. Figure 2 illustrates the typical calibrated carrier feedthrough performance of the HMC1097LP4E. In this characterization of the HMC1097LP4E, carrier feedthrough was calibrated with 500MHz LO frequency steps at 25C and external offset voltage settings were held constant during tests over temperature. For instance, the required the Q channel offset is 2mV and the I channel offset is -3mV at 2.5GHz.

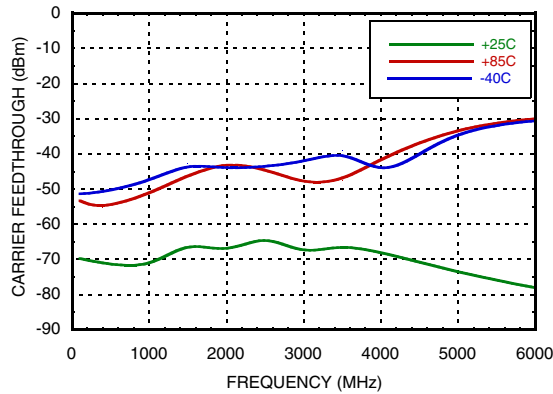

Figure 2: The HMC1097LP4E Calibrated Carrier Feedthrough

### Sideband Suppression Calibration

Sideband suppression is related to relative gain and relative phase offsets between the I-channel and Q-channel. The amplitude and phase difference between the I and Q inputs can be adjusted in order to optimize the sideband suppression for a specific frequency band and LO power level. The amplitude and phase offsets at the I and Q inputs should be iteratively adjusted until a minimum sideband suppression level is obtained. The externally available amplitude and phase steps and the modulator's noise floor limit the minimum achievable calibrated sideband suppression level. Figure 3 illustrates the typical calibrated sideband suppression performance of the HMC1097LP4E. In this characterization of the HMC1097LP4E, sideband suppression was calibrated with 500MHz LO frequency steps at 25C and external amplitude and phase offset settings were held constant during tests over temperature. For instance, gain imbalance is equal to -0.03dB and phase imbalance is equal to -0.25deg at 2.5GHz.

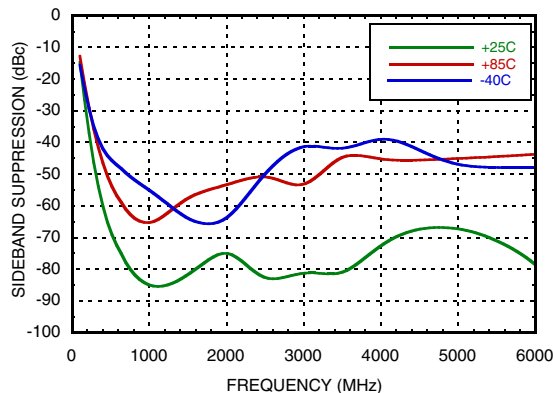

Figure 3: The HMC1097LP4E Calibrated Sideband Suppression

### Linearity Optimization

Output IP3 (OIP3) of the HMC1097LP4E depends on the DC common-mode level at the I and Q baseband inputs. The DC common-mode level at the I and Q baseband inputs can be adjusted in order to optimize the OIP3 for a specific frequency band. Figure 4 illustrates the typical relationship between OIP3 and the DC common-mode level at the I and Q baseband inputs for different LO frequencies. As shown in Figure 4, OIP3 of the HMC1097LP4E can be optimized up to 35dBm.

## WIDEBAND DIRECT QUADRATURE MODULATOR, 100 - 6000 MHz

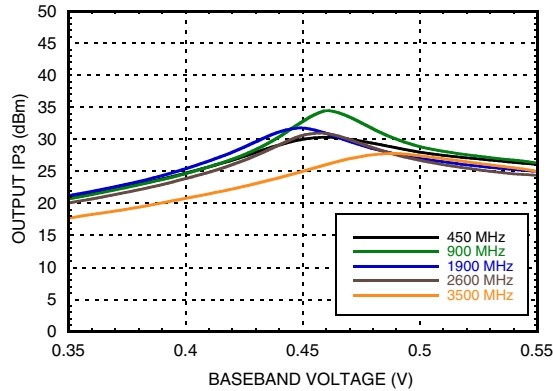

Figure 4: The HMC1097LP4E Linearity Optimization

### GSM/EDGE Operation

The HMC1097LP4E is suitable for GSM/EDGE applications. The EVM performance of the HMC1097LP4E in a GSM/EDGE environment is shown in Figure 5.

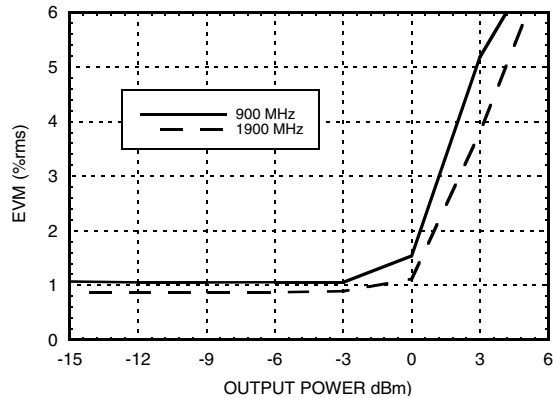

Figure 5: The HMC1097LP4E EVM vs. Output Power @ GSM/EDGE(8-PSK)

### Wimax Operation

The HMC1097LP4E is suitable for Wimax applications. The EVM performance of the HMC1097LP4E in a Wimax environment is shown in Figure 6.

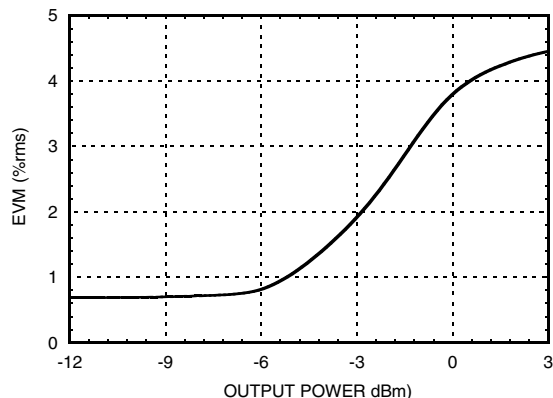

Figure 6: The HMC1097LP4E EVM vs. Output Power @ Wimax 64QAM 3500MHz

### W-CDMA Operation

The HMC1097LP4E is suitable for W-CDMA operation. Figure 7 shows the adjacent and alternate channel power ratios for the HMC1097LP4E at an LO frequency of 2140 MHz. The HMC1097LP4E is able to deliver about -73 dBc ACPR and -80 dBc AltCPR at an output power of -10 dBm. ACPR and AltCPR performances of the HMC1097LP4E can be improved by adjusting the DC common-mode level on the I and Q baseband inputs.

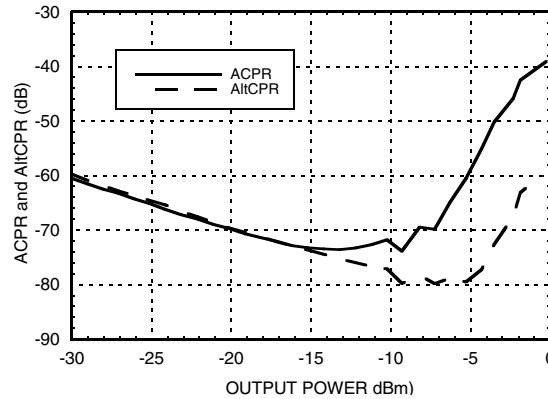

Figure 7: The HMC1097LP4E ACPR and AltCPR vs. Output Power @ WCDMA

### LTE Operation

The HMC1097LP4E is suitable for LTE applications. The EVM performance of the HMC1097LP4E in a LTE environment is shown in Figure 8.

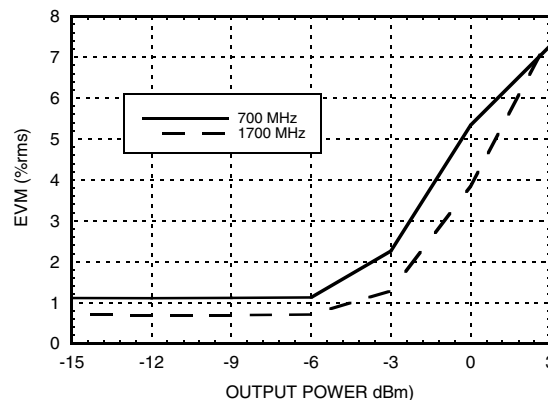

Figure 8: The HMC1097LP4E EVM vs. Output Power @ LTE Downlink 25RB QPSK