

GaAs MMIC DOUBLE-BALANCED MIXER, 6 - 18 GHz

Typical Applications

The HMC141 & HMC142 is ideal for:

- UNII & HiperLAN
- Microwave & MMW Radios
- Military, Space & Test Equipment

Features

- Input IP3: +21 dBm
- LO / RF Isolation: 25 to 40 dB
- IF Bandwidth: DC to 6 GHz
- Small Size: 1.52 x 1.52 x 0.1 mm (HMC141)
- Small Size: 1.52 x 1.52 x 0.1 mm (HMC142)

Functional Diagram

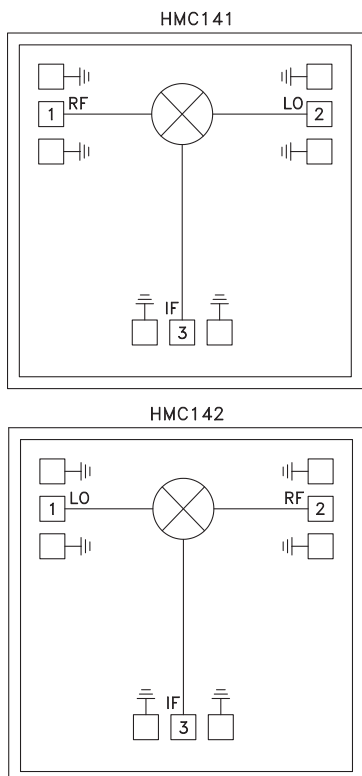

General Description

The HMC141 chip is a miniature double-balanced mixer which can be used as an upconverter or downconverter. The HMC142 is identical to the HMC141 except that the layout is a mirror image designed to ease integration into image-reject mixer modules. Broadband operation and excellent isolations are provided by on-chip baluns, which require no external components and no DC bias. The design is similar to the HMC143/144 mixers but without an IF combiner, providing a broad DC to 6 GHz IF bandwidth. These devices are much smaller and more reliable than hybrid diode mixers for VSAT and point-to-point radios.

Electrical Specifications, $T_A = +25^\circ\text{C}$, LO Drive = +20 dBm

Parameter	IF = 100 MHz LO = 20 dBm						Units
	Min.	Typ.	Max.	Min.	Typ.	Max.	
Frequency Range, RF & LO	6 - 16			16 - 18			GHz
Frequency Range, IF	DC - 6			DC - 6			GHz
Conversion Loss		9	11		10	12	dB
Noise Figure (SSB)		9	11		10	12	dB
LO to RF Isolation		33			28		dB
LO to IF Isolation	20	30		13	20		dB
IP3 (Input)		22			22		dBm
IP2 (Input)		40			42		dBm
1 dB Compression (Input)		15			15		dBm

* Unless otherwise noted, all measurements performed as downconverter, IF= 100 MHz.

For price, delivery and to place orders: Hittite Microwave Corporation, 20 Alpha Road, Chelmsford, MA 01824

Phone: 978-250-3343 Fax: 978-250-3373 Order On-line at www.hittite.com

Application Support: Phone: 978-250-3343 or apps@hittite.com

www.BDTIC.com/Hittite/

GaAs MMIC DOUBLE-BALANCED MIXER, 6 - 18 GHz

Conversion Gain vs. Temperature @ LO = +20 dBm

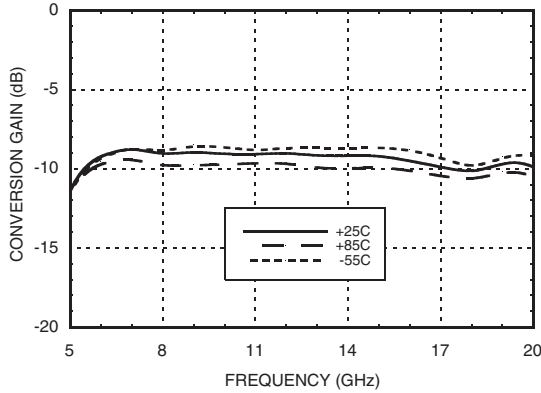

Isolation @ LO = +20 dBm

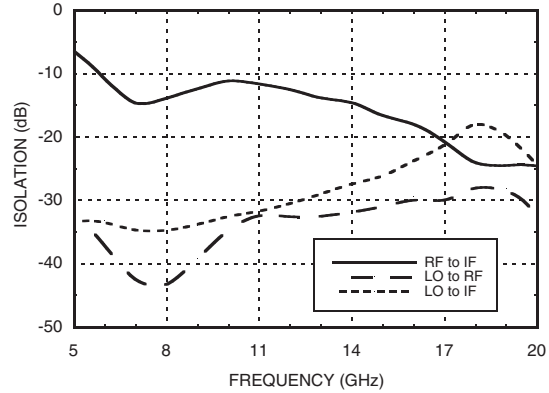

Conversion Gain vs. LO Drive

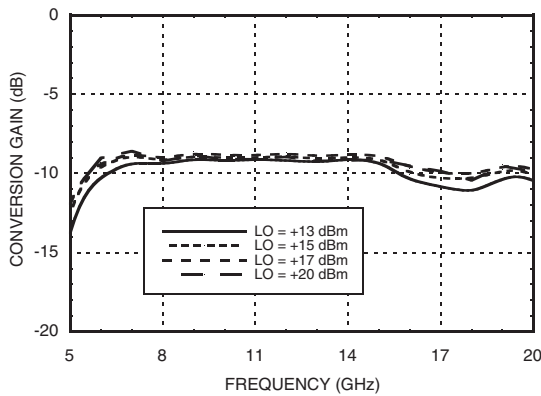

Return Loss @ LO = +20 dBm

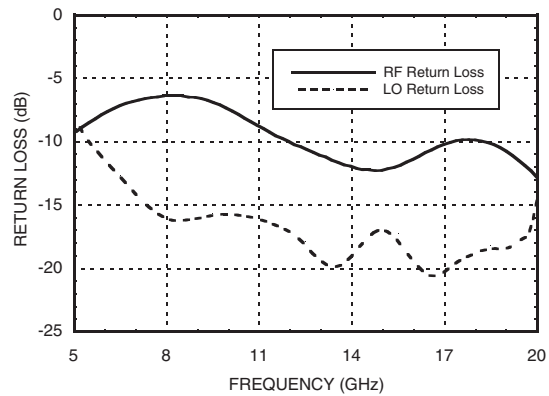

IF Bandwidth @ LO = +20 dBm

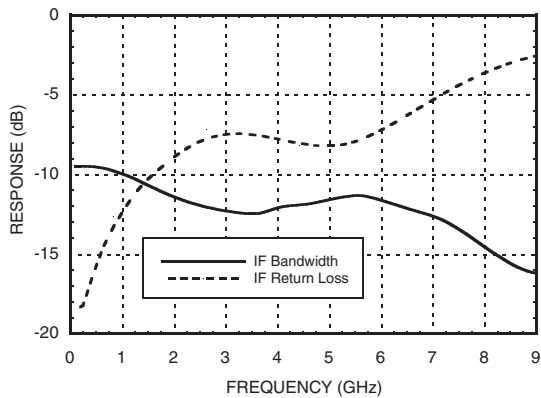

Upconverter Performance Conversion Gain @ LO = +20 dBm

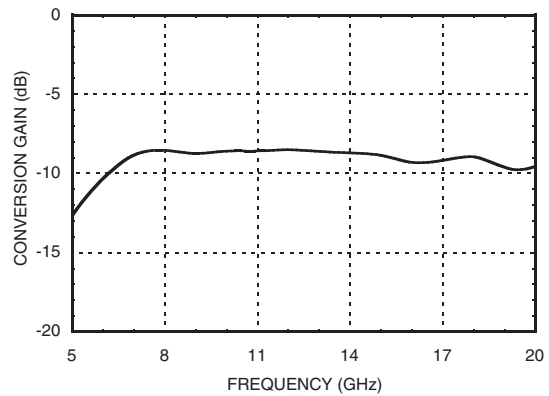

GaAs MMIC DOUBLE-BALANCED MIXER, 6 - 18 GHz

Input IP3 vs. LO Drive*

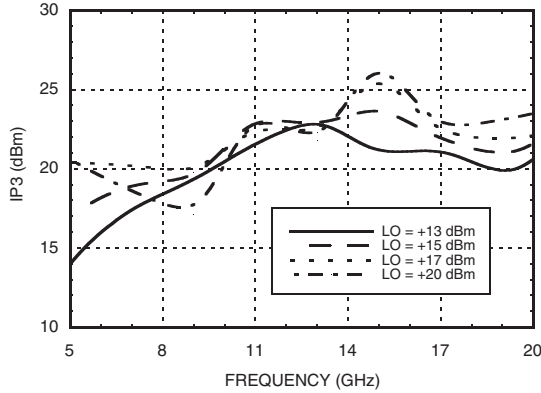

Input IP3 vs. Temperature @ LO = +20 dBm*

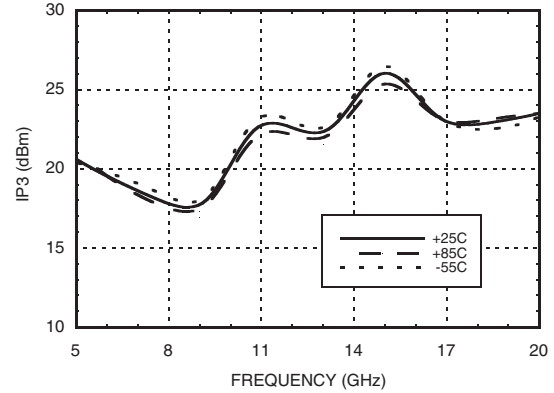

Input IP2 vs. LO Drive *

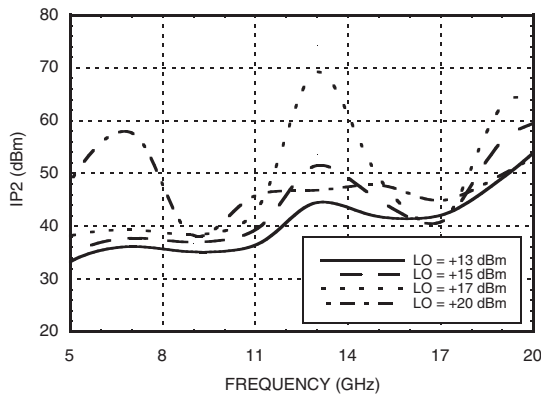

Input P1dB vs. Temperature @ LO = +20 dBm

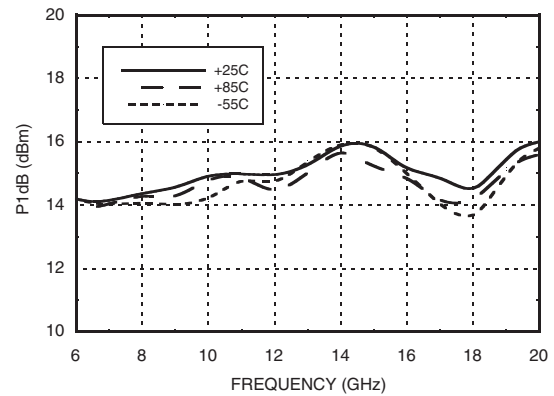

MxN Spurious @ IF Port

mRF	nLO				
	0	1	2	3	4
0	XX	3	7	3	35
1	3	0	17	25	32
2	72	64	59	59	74
3	76	76	71	72	76
4	74	76	77	77	77

RF = 6 GHz @ -10 dBm
LO = 6.1 GHz @ +20 dBm
All values in dBc relative to the IF power level.
Measured as downconverter.

Harmonics of LO

LO Freq. (GHz)	nLO Spur @ RF Port			
	1	2	3	4
6	38	34	44	39
8	44	29	46	43
10	36	25	46	53
12	33	23	47	XX
14	32	28	XX	XX
16	30	27	XX	XX
18	27	32	XX	XX

LO = +20 dBm
All values in dBc below input LO level @ RF port.

* Two-tone input power = 0 dBm each tone, 1 MHz spacing.

**GaAs MMIC DOUBLE-BALANCED
MIXER, 6 - 18 GHz**

Outline Drawings

(See HMC141/142 Operation Application Note)

HMC141

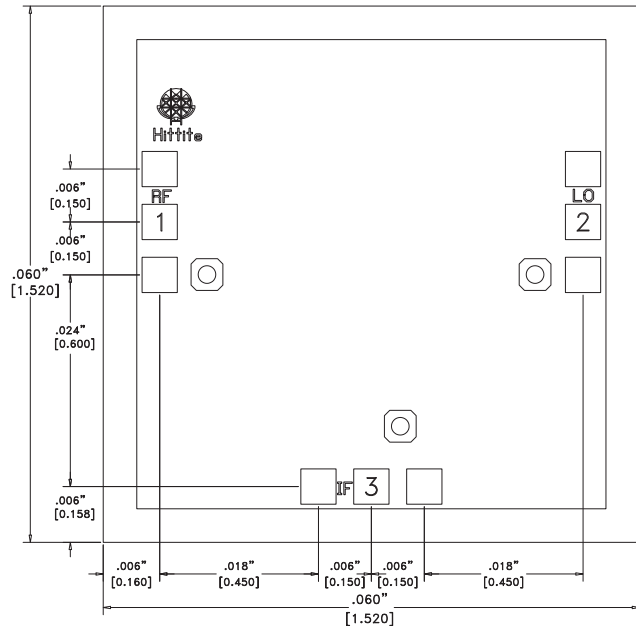

Absolute Maximum Ratings

RF / IF Input	+20 dBm
LO Drive	+27 dBm
Channel Temperature (Tc)	150 °C
Thermal Resistance	101.7 °C/W
IF DC Current	±2 mA
Storage Temperature	-65 to +150 °C
Operating Temperature	-55 to +85 °C



**ELECTROSTATIC SENSITIVE DEVICE
OBSERVE HANDLING PRECAUTIONS**

NOTES:

1. ALL DIMENSIONS ARE IN INCHES [MM].
2. DIE THICKNESS IS .004".
3. TYPICAL BOND PAD IS .004" SQUARE.
4. BACKSIDE METALLIZATION: GOLD.
5. BOND PAD METALLIZATION: GOLD.
6. BACKSIDE METAL IS GROUND.
7. CONNECTION NOT REQUIRED FOR UNLABELED BOND PADS.

HMC142

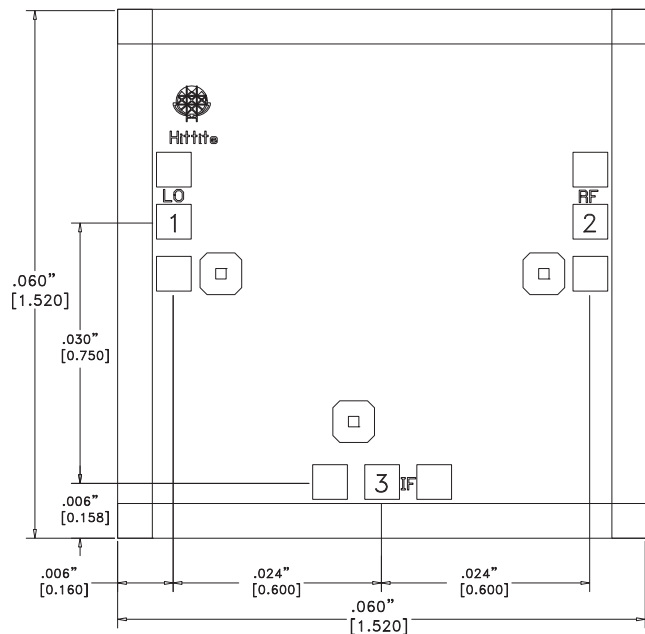

Die Packaging Information [1]

Standard	Alternate
WP-3 (Waffle Pack)	[2]

[1] Refer to the "Packaging Information" section for die packaging dimensions.

[2] For alternate packaging information contact Hittite Microwave Corporation.

Pad Descriptions HMC141 (HMC142)

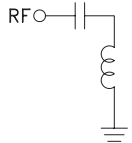
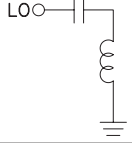
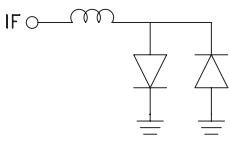
Pad Number	Function	Description	Interface Schematic
1 (2)	RF	This pin is AC coupled and matched to 50 Ohms.	
2 (1)	LO	This pin is AC coupled and matched to 50 Ohms.	
3	IF	This pin is DC coupled. For applications not requiring operation to DC, this port should be DC blocked externally using a series capacitor whose value has been chosen to pass the necessary IF frequency range. For operation to DC, this pin must not source/sink more than 2 mA of current or die non-function and possible die failure will result.	

**GaAs MMIC DOUBLE-BALANCED
MIXER, 6 - 18 GHz**

Mounting & Bonding Techniques for Millimeterwave GaAs MMICs

The die should be attached directly to the ground plane eutectically or with conductive epoxy (see HMC general Handling, Mounting, Bonding Note).

50 Ohm Microstrip transmission lines on 0.127mm (5 mil) thick alumina thin film substrates are recommended for bringing RF to and from the chip (Figure 1). If 0.254mm (10 mil) thick alumina thin film substrates must be used, the die should be raised 0.150mm (6 mils) so that the surface of the die is coplanar with the surface of the substrate. One way to accomplish this is to attach the 0.102mm (4 mil) thick die to a 0.150mm (6 mil) thick molybdenum heat spreader (moly-tab) which is then attached to the ground plane (Figure 2).

Microstrip substrates should be brought as close to the die as possible in order to minimize ribbon bond length. Typical die-to-substrate spacing is 0.076mm (3 mils). Gold ribbon of 0.075 mm (3 mil) width and minimal length <0.31 mm (<12 mils) is recommended to minimize inductance on RF, LO & IF ports.

Handling Precautions

Follow these precautions to avoid permanent damage.

Storage: All bare die are placed in either Waffle or Gel based ESD protective containers, and then sealed in an ESD protective bag for shipment. Once the sealed ESD protective bag has been opened, all die should be stored in a dry nitrogen environment.

Cleanliness: Handle the chips in a clean environment. DO NOT attempt to clean the chip using liquid cleaning systems.

Static Sensitivity: Follow ESD precautions to protect against ESD strikes.

Transients: Suppress instrument and bias supply transients while bias is applied. Use shielded signal and bias cables to minimize inductive pick-up.

General Handling: Handle the chip along the edges with a vacuum collet or with a sharp pair of bent tweezers. The surface of the chip has fragile air bridges and should not be touched with vacuum collet, tweezers, or fingers.

Mounting

The chip is back-metallized and can be die mounted with AuSn eutectic preforms or with electrically conductive epoxy. The mounting surface should be clean and flat.

Eutectic Die Attach: A 80/20 gold tin preform is recommended with a work surface temperature of 255 °C and a tool temperature of 265 °C. When hot 90/10 nitrogen/hydrogen gas is applied, tool tip temperature should be 290 °C. DO NOT expose the chip to a temperature greater than 320 °C for more than 20 seconds. No more than 3 seconds of scrubbing should be required for attachment.

Epoxy Die Attach: Apply a minimum amount of epoxy to the mounting surface so that a thin epoxy fillet is observed around the perimeter of the chip once it is placed into position. Cure epoxy per the manufacturer's schedule.

Wire Bonding

RF bonds made with 0.003" x 0.0005" ribbon are recommended. These bonds should be thermosonically bonded with a force of 40-60 grams. DC bonds of 0.001" (0.025 mm) diameter, thermosonically bonded, are recommended. Ball bonds should be made with a force of 40-50 grams and wedge bonds at 18-22 grams. All bonds should be made with a nominal stage temperature of 150 °C. A minimum amount of ultrasonic energy should be applied to achieve reliable bonds. All bonds should be as short as possible, less than 12 mils (0.31 mm).

