



GaAs MMIC SMT PASSIVE FREQUENCY DOUBLER, 4 - 8 GHz INPUT

Typical Applications

The HMC204MS8G / HMC204MS8GE is suitable for:

- Wireless Local Loop
- LMDS, VSAT, and Point-to-Point Radios
- UNII & HiperLAN
- Test Equipment

Features

- Conversion Loss: 17 dB
- Fo, 3Fo, 4Fo Isolation: 42 dB
- Passive: No Bias Required
- Ultra Small Package: MSOP8

Functional Diagram

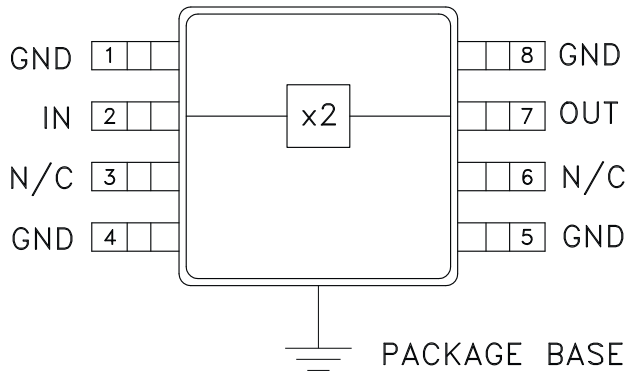

General Description

The HMC204MS8G & HMC204MS8GE are passive miniature frequency doublers in 8 lead MSOP surface mount packages. Suppression of undesired fundamental and higher order harmonics is 42 dB typical with respect to input signal level. The doubler utilizes the same GaAs Schottky diode/balun technology found in Hittite MMIC mixers. It requires no DC bias and adds no measurable phase noise onto the multiplied signal.

Electrical Specifications, $T_A = +25^\circ\text{C}$, As a Function of Drive Level

Parameter	Input = +10 dBm			Input = +12 dBm			Input = +15 dBm			Units
	Min.	Typ.	Max.	Min.	Typ.	Max.	Min.	Typ.	Max.	
Frequency Range, Input	5.5 - 7.5			5.0 - 8.0			4.0 - 8.0			GHz
Frequency Range, Output	11.0 - 15.0			10.0 - 16.0			8.0 - 16.0			GHz
Conversion Loss		17	21		17	22		17	21	dB
FO Isolation (with respect to input level)	37	42		37	42		39	45		dB
3FO Isolation (with respect to input level)	37	45		37	45		35	45		dB
4FO Isolation (with respect to input level)	45	55		40	50		35	45		dB



GaAs MMIC SMT PASSIVE FREQUENCY DOUBLER, 4 - 8 GHz INPUT

Conversion Gain vs. Temperature @ +15 dBm Drive Level

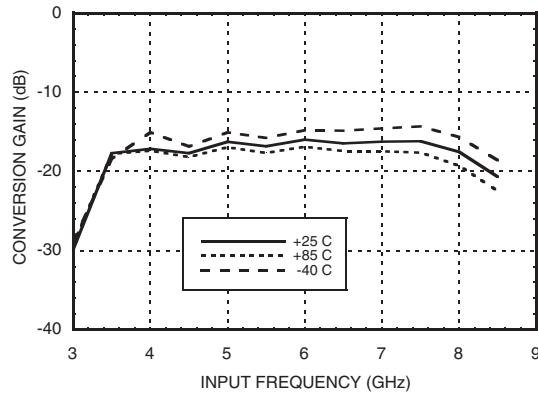

Conversion Gain @ +25° vs. Drive Level

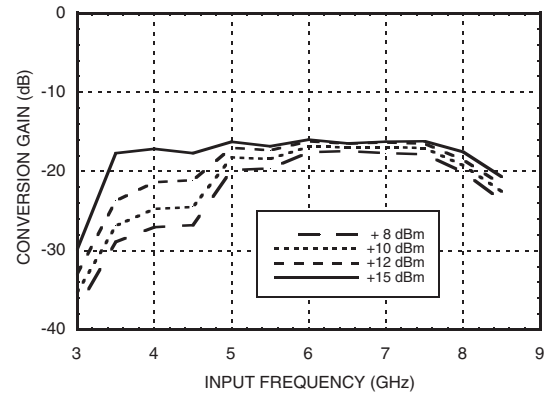

Isolation @ +15 dBm Drive Level*

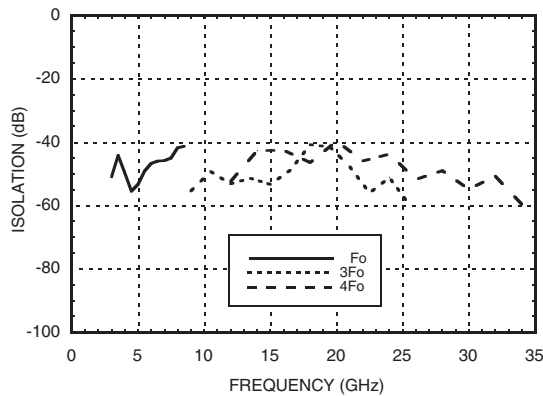

Input Return Loss vs. Drive Level

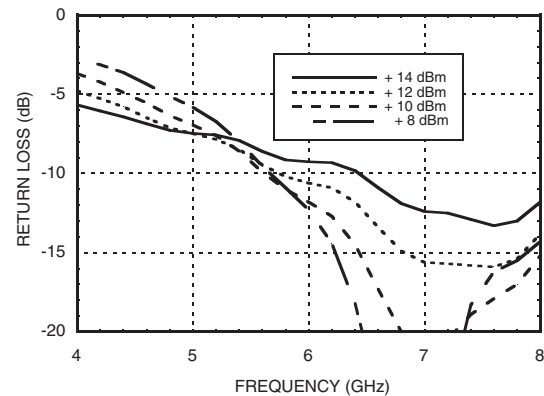

*With respect to input level

Output Return Loss

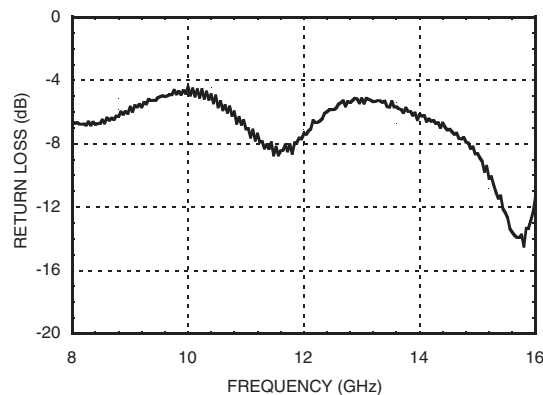

Absolute Maximum Ratings

Input Drive	+27 dBm
Storage Temperature	-65 to +150 °C
Operating Temperature	-40 to +85 °C



ELECTROSTATIC SENSITIVE DEVICE
OBSERVE HANDLING PRECAUTIONS

Outline Drawing

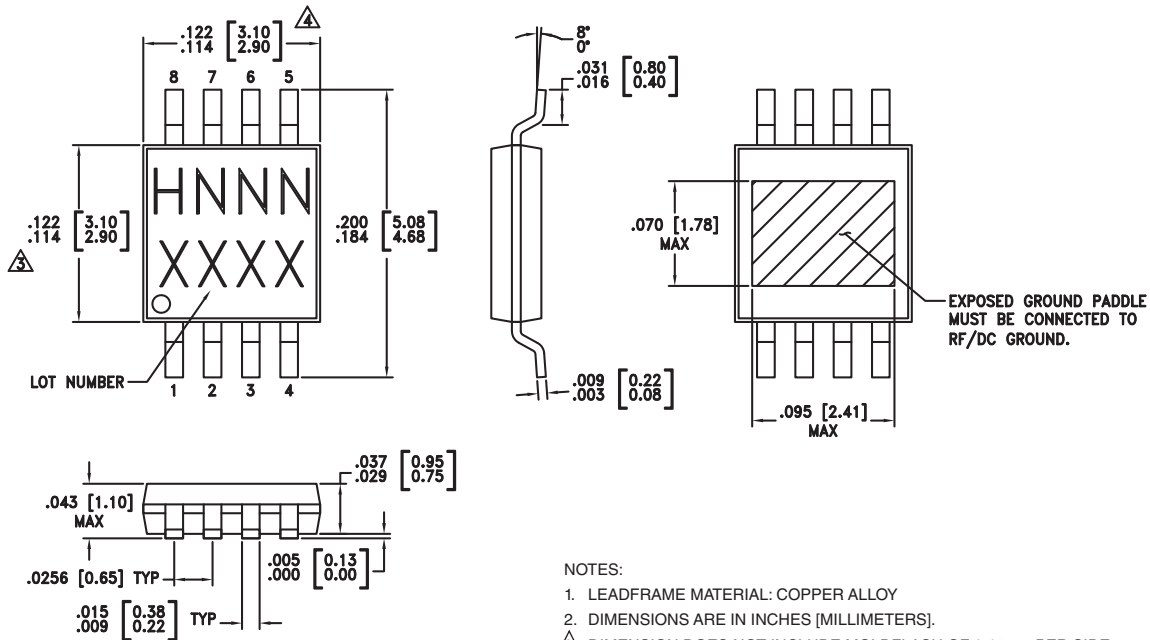

Package Information

Part Number	Package Body Material	Lead Finish	MSL Rating	Package Marking ^[3]
HMC204MS8G	Low Stress Injection Molded Plastic	Sn/Pb Solder	MSL1 ^[1]	H204 XXXX
HMC204MS8GE	RoHS-compliant Low Stress Injection Molded Plastic	100% matte Sn	MSL1 ^[2]	H204 XXXX

[1] Max peak reflow temperature of 235 °C

[2] Max peak reflow temperature of 260 °C

[3] 4-Digit lot number XXXX

For price, delivery, and to place orders, please contact Hittite Microwave Corporation:
 20 Alpha Road, Chelmsford, MA 01824 Phone: 978-250-3343 Fax: 978-250-3373

Order On-Line at www.hittite.com
www.BDTIC.com/Hittite/

Evaluation PCB

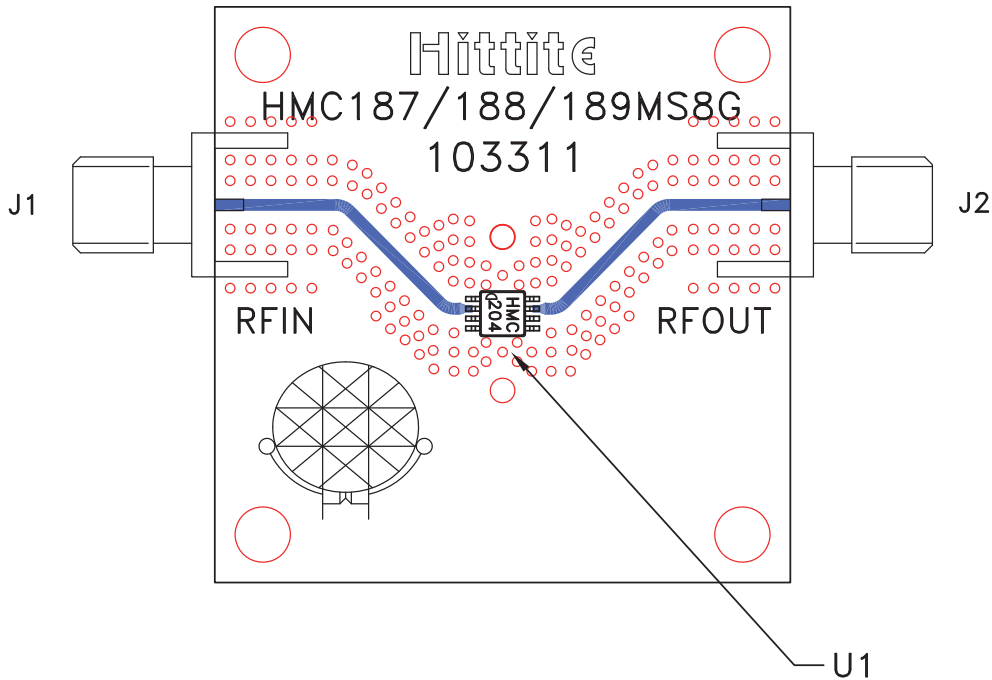

List of Materials for Evaluation PCB 103313 [1]

Item	Description
J1, J2	PCB Mount SMA Connector
U1	HMC204MS8G / HMC204MS8GE
PCB [2]	103311 Eval Board

[1] Reference this number when ordering complete evaluation PCB

[2] Circuit Board Material: Rogers 4350

The circuit board used in the final application should be generated with proper RF circuit design techniques. Signal lines at the RF port should have 50 ohm impedance and the package ground leads and exposed ground paddle should be connected directly to the ground plane similar to that shown above. The evaluation circuit board shown above is available from Hittite Microwave Corporation upon request.