

GaAs PHEMT MMIC MEDIUM POWER AMPLIFIER, 12 - 30 GHz

Typical Applications

The HMC383LC4 is ideal for:

- Point-to-Point Radios
- Point-to-Multi-Point Radios & VSAT
- Test Equipment & Sensors
- LO Driver for HMC Mixers
- Military & Space

Features

- Gain: 15 dB
- Saturated Output Power: +18 dBm
- Output IP3: +25 dBm
- Single Positive Supply: +5V @ 100 mA
- 50 Ohm Matched Input/Output
- RoHS Compliant 4x4 mm Package

Functional Diagram

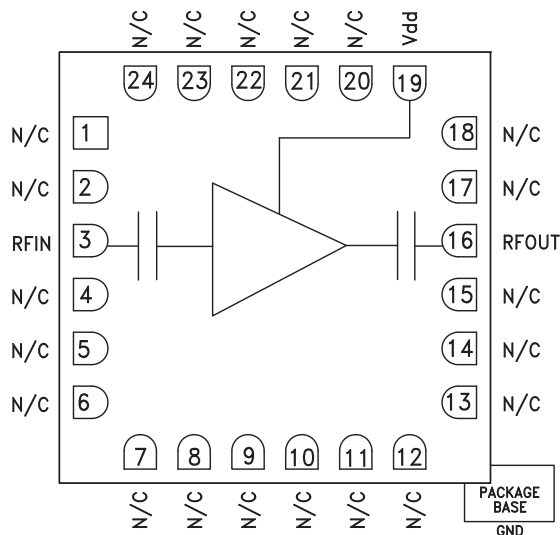

General Description

The HMC383LC4 is a general purpose GaAs PHEMT MMIC Driver Amplifier housed in a leadless RoHS compliant SMT package. The amplifier provides 15 dB of gain and +18 dBm of saturated power from a single +5V supply. Consistent gain and output power across the operating band make it possible to use a common driver/LO amplifier approach in multiple radio bands. The RF I/Os are DC blocked and matched to 50 Ohms for ease of use. The HMC383LC4 is housed in a RoHS compliant leadless 4x4 mm package allowing the use of surface mount manufacturing techniques.

Electrical Specifications, $T_A = +25^\circ C$, $V_{dd} = +5V$

| Parameter | Min. | Typ. | Max. | Min. | Typ. | Max. | Min. | Typ. | Max. | Min. | Typ. | Max. | Units |
|--|---------|------|------|---------|------|------|---------|------|------|---------|------|------|--------|
| Frequency Range | 12 - 16 | | | 16 - 24 | | | 24 - 28 | | | 28 - 30 | | | GHz |
| Gain | 12 | 15 | | 13 | 16 | | 12 | 15 | | 10 | 13 | | dB |
| Gain Variation Over Temperature | | 0.02 | 0.03 | | 0.02 | 0.03 | | 0.02 | 0.03 | | 0.02 | 0.03 | dB/ °C |
| Input Return Loss | | 14 | | | 14 | | | 11 | | | 13 | | dB |
| Output Return Loss | | 14 | | | 17 | | | 10 | | | 8 | | dB |
| Output Power for 1 dB Compression (P1dB) | 12 | 15 | | 13.5 | 16.5 | | 13 | 16 | | 12 | 15 | | dBm |
| Saturated Output Power (Psat) | | 17 | | | 18 | | | 17 | | | 16 | | dBm |
| Output Third Order Intercept (IP3) | | 24 | | | 25 | | | 25 | | | 23 | | dBm |
| Noise Figure | | 10.5 | | | 8 | | | 7.5 | | | 8 | | dB |
| Supply Current (Idd) | 75 | 100 | 135 | 75 | 100 | 135 | 75 | 100 | 135 | 75 | 100 | 135 | mA |

GaAs PHEMT MMIC MEDIUM POWER AMPLIFIER, 12 - 30 GHz

Broadband Gain & Return Loss

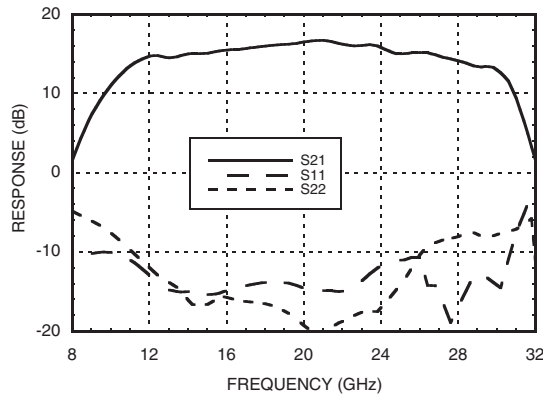

Gain vs. Temperature

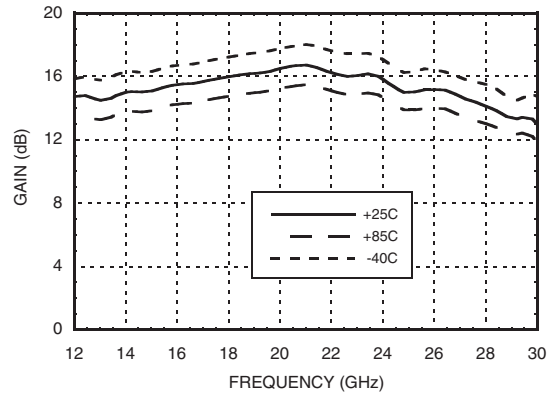

Input Return Loss vs. Temperature

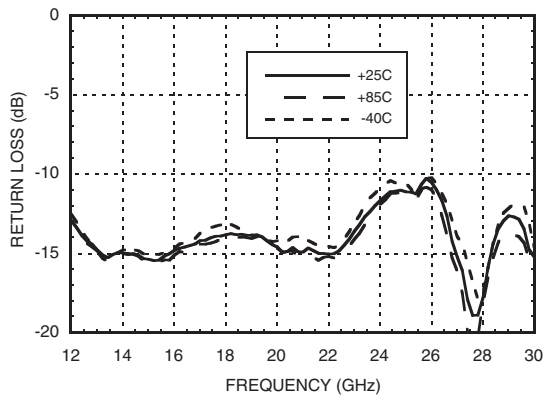

Output Return Loss vs. Temperature

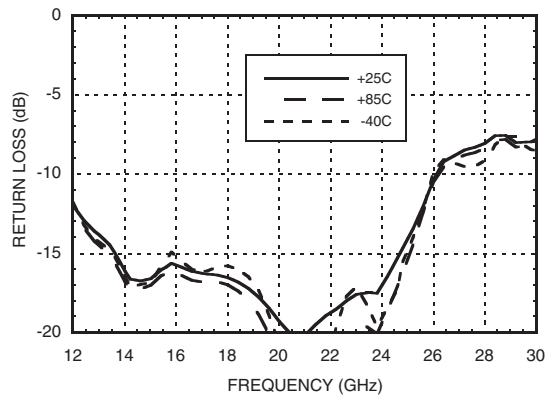

P1dB vs. Temperature

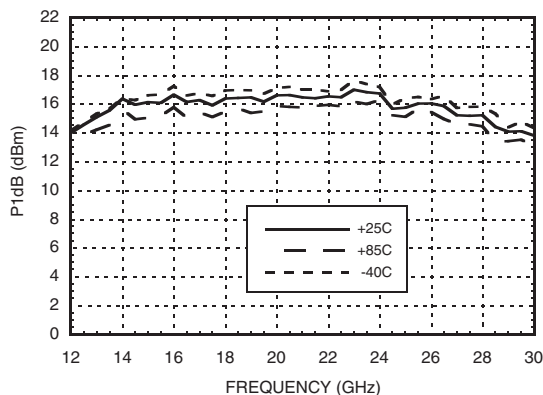

Psat vs. Temperature

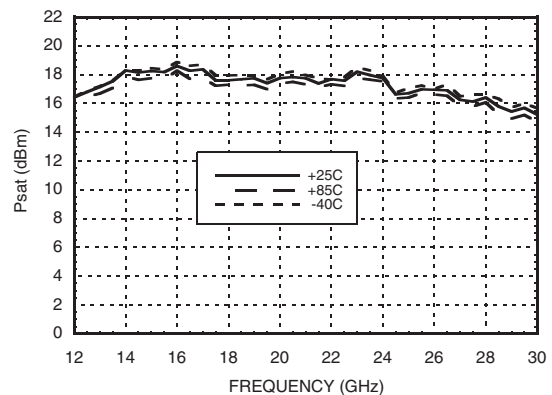

11

LINEAR & POWER AMPLIFIERS - SMT

For price, delivery, and to place orders, please contact Hittite Microwave Corporation:
 20 Alpha Road, Chelmsford, MA 01824 Phone: 978-250-3343 Fax: 978-250-3373

www.BDTIC.com/Hittite/

GaAs PHEMT MMIC MEDIUM POWER AMPLIFIER, 12 - 30 GHz

Power Compression @ 18 GHz

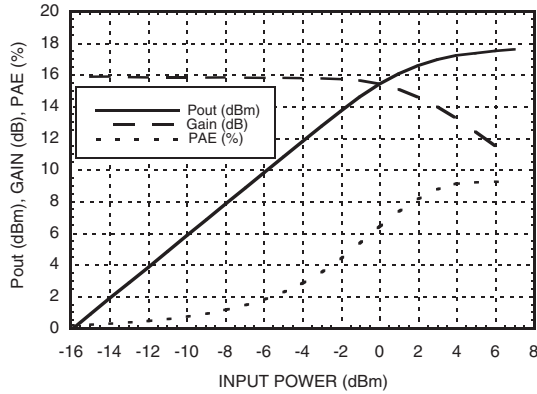

Power Compression @ 30 GHz

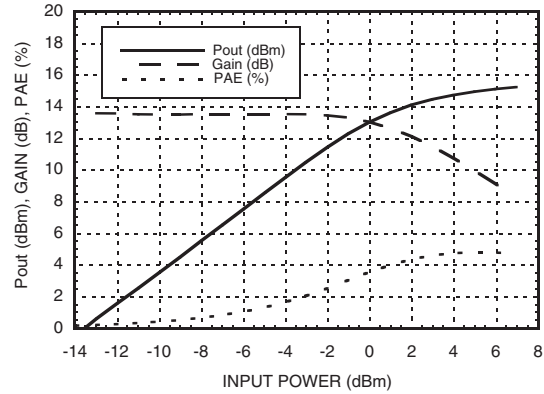

Output IP3 vs. Temperature

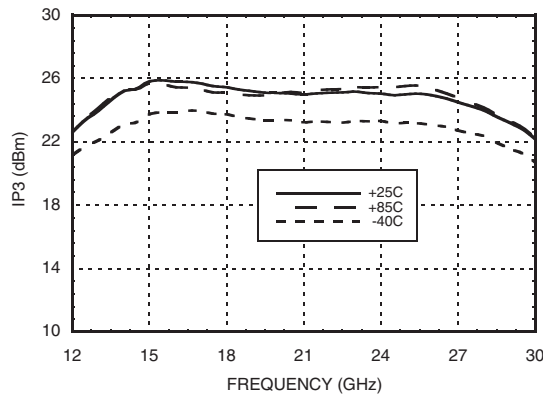

Noise Figure vs. Temperature

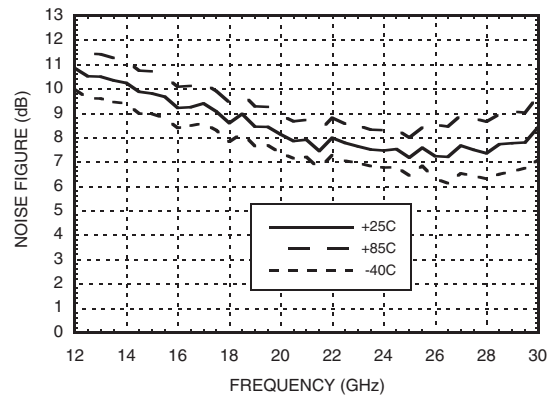

Gain & Power vs. Supply Voltage @ 18 GHz

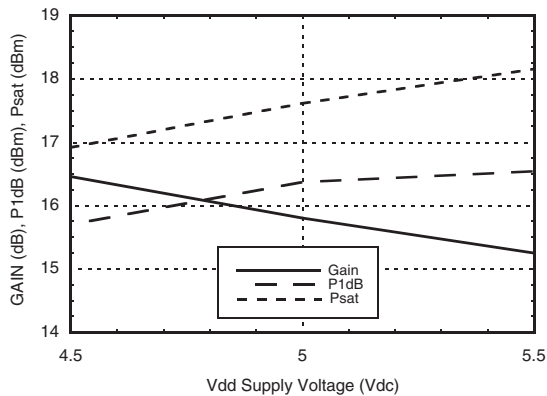

Reverse Isolation vs. Temperature

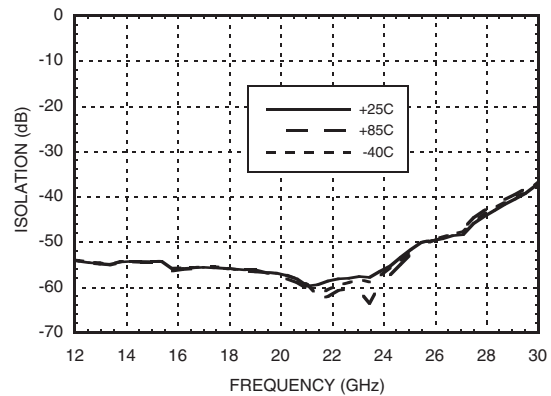



**GaAs PHEMT MMIC MEDIUM
POWER AMPLIFIER, 12 - 30 GHz**

Absolute Maximum Ratings

| | |
|--|----------------|
| Drain Bias Voltage (Vdd) | +5.5 Vdc |
| RF Input Power (RFIN)(Vdd = +5Vdc) | +10 dBm |
| Channel Temperature | 175 °C |
| Continuous Pdiss (T= 85 °C) (derate 10 mW/°C above 85 °C) | 0.92 W |
| Thermal Resistance (channel to ground paddle) | 98 °C/W |
| Storage Temperature | -65 to +150 °C |
| Operating Temperature | -40 to +85 °C |
| ESD Sensitivity (HBM) | Class 1A |

Typical Supply Current vs. Vdd

| Vdd (V) | Idd (mA) |
|---------|----------|
| +4.5 | 99 |
| +5.0 | 100 |
| +5.5 | 101 |

Note: Amplifier will operate over full voltage ranges shown above

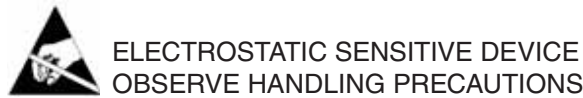

Outline Drawing

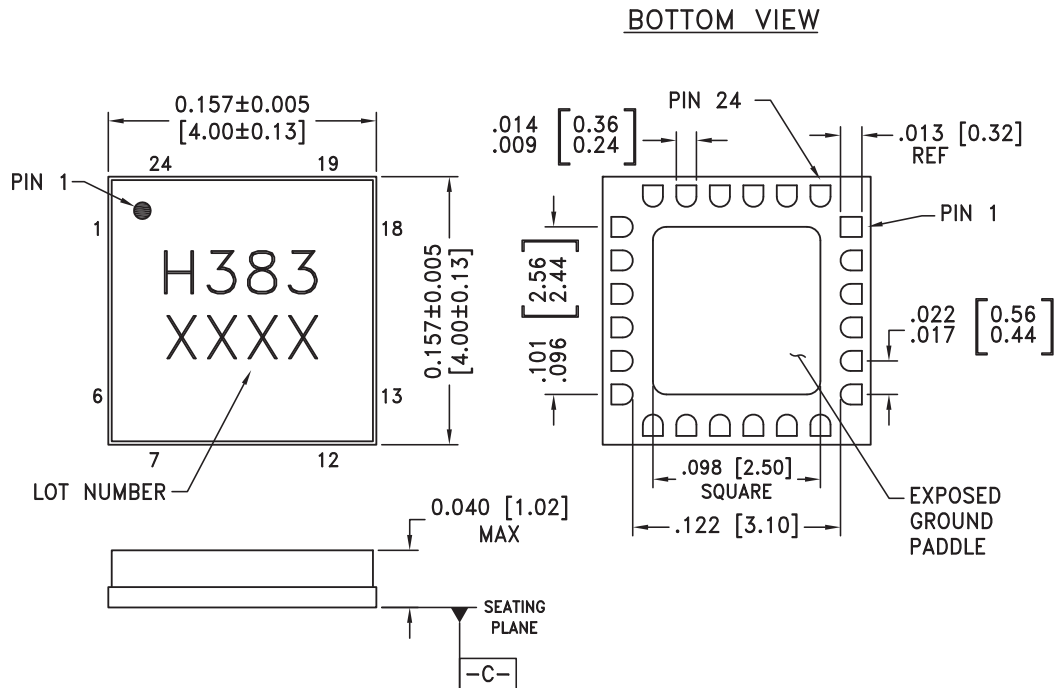

- NOTES:
1. PACKAGE BODY MATERIAL: ALUMINA
 2. LEAD AND GROUND PADDLE PLATING: 30-80 MICROINCHES GOLD OVER 50 MICROINCHES MINIMUM NICKEL.
 3. ALL DIMENSIONS ARE IN INCHES [MM]
 4. LEAD SPACING TOLERANCE IS NON-CUMULATIVE
 5. PACKAGE WARP SHALL NOT EXCEED 0.05mm DATUM -C-
 6. ALL GROUND LEADS AND GROUND PADDLE MUST BE SOLDERED TO PCB RF GROUND

For price, delivery, and to place orders, please contact Hittite Microwave Corporation:
20 Alpha Road, Chelmsford, MA 01824 Phone: 978-250-3343 Fax: 978-250-3373

www.BDTIC.com/Hittite/



GaAs PHEMT MMIC MEDIUM POWER AMPLIFIER, 12 - 30 GHz

Pin Descriptions

| Pin Number | Function | Description | Interface Schematic |
|---------------------------|----------|---|---------------------|
| 1, 2, 4-15, 17, 18, 20-24 | N/C | No connection required. These pins may be connected to RF/DC ground without affecting performance if using grounded coplanar wave guide transmission lines. | |
| 3 | RFIN | This pad is AC coupled and matched to 50 Ohms. | |
| 16 | RFOUT | This pad is AC coupled and matched to 50 Ohms. | |
| 19 | Vdd | Power Supply Voltage for the amplifier. External bypass capacitors of 100 pF, 1,000 pF and 2.2 μF are required. | |
| | GND | Package base has an exposed metal ground that must be connected to RF/DC ground. Vias under the device are required | |

Application Circuit

| Component | Value |
|-----------|----------|
| C1 | 100 pF |
| C2 | 1,000 pF |
| C3 | 2.2 μF |

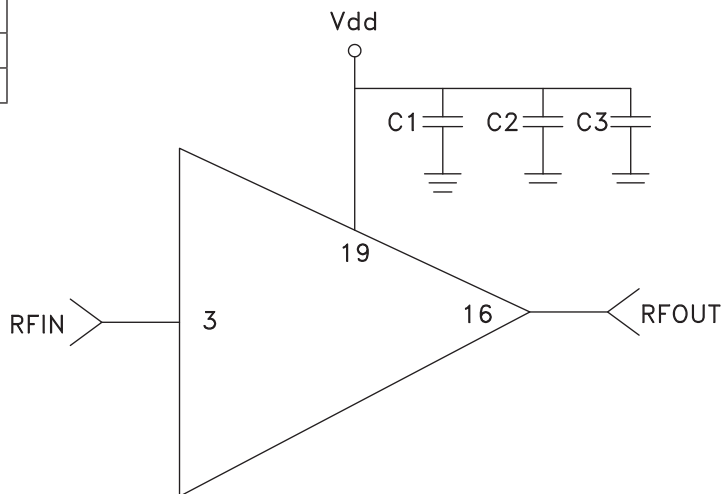

Evaluation PCB

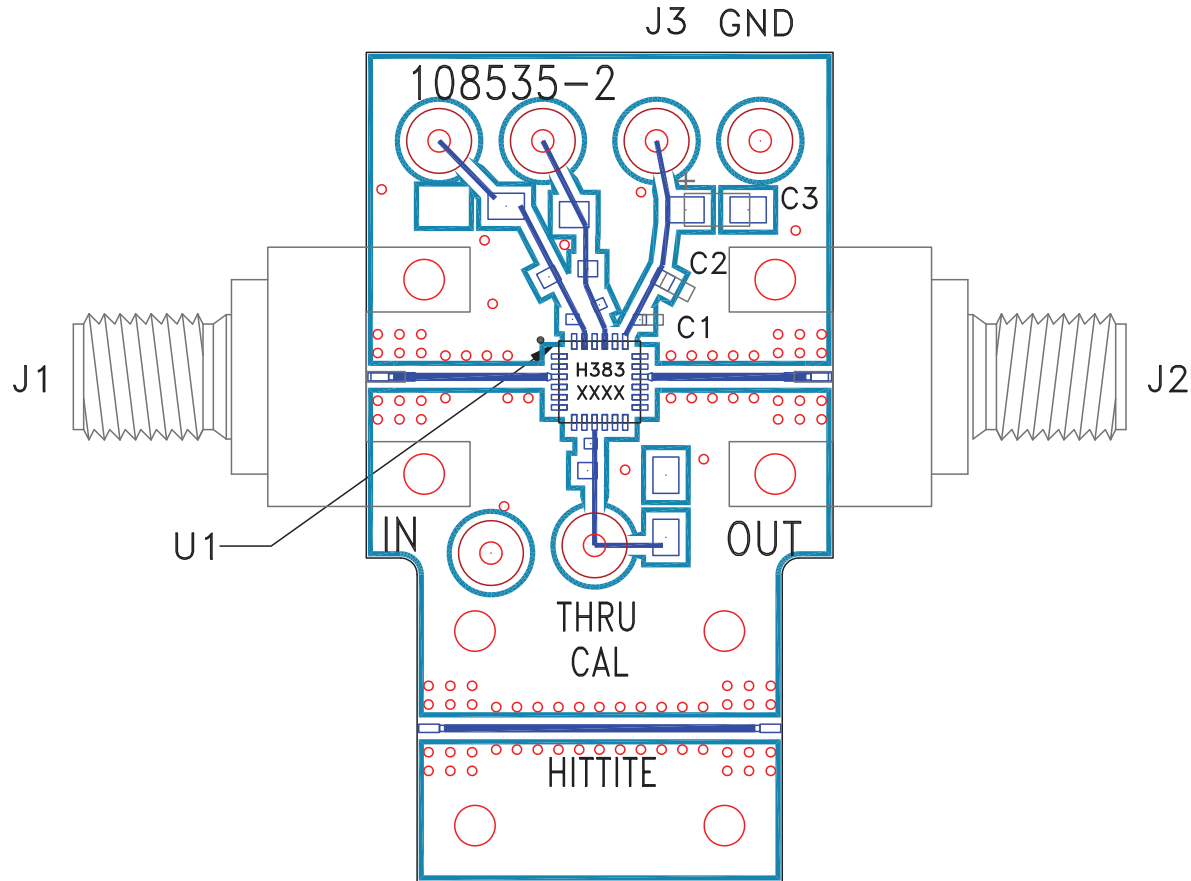

List of Materials for Evaluation PCB 122198 [1]

| Item | Description |
|---------|-------------------------------|
| J1, J2 | 2.92 mm PCB mount K-connector |
| J3, J4 | DC Pin |
| C1 | 100 pF capacitor, 0402 pkg. |
| C2 | 1,000 pF Capacitor, 0603 pkg. |
| C3 | 2.2µF Capacitor, Tantalum |
| U1 | HMC383LC4 Amplifier |
| PCB [2] | 108535 Evaluation PCB |

[1] Reference this number when ordering complete evaluation PCB

[2] Circuit Board Material: Rogers 4350.

The circuit board used in this application should use RF circuit design techniques. Signal lines should have 50 ohm impedance while the package ground leads and exposed paddle should be connected directly to the ground plane similar to that shown. A sufficient number of via holes should be used to connect the top and bottom ground planes. The evaluation board should be mounted to an appropriate heat sink. The evaluation circuit board shown is available from Hittite upon request.