



HMC510LP5 / 510LP5E

MMIC VCO w/ HALF FREQUENCY OUTPUT & DIVIDE-BY-4, 8.45 - 9.55 GHz

Typical Applications

Low noise MMIC VCO w/Half Frequency, Divide-by-4 Outputs for:

- Point to Point/Multipoint Radio
- Test Equipment & Industrial Controls
- SATCOM
- Military End-Use

Features

- Dual Output: $F_o = 8.45 - 9.55$ GHz
 $F_o/2 = 4.225 - 4.775$ GHz
- Pout: +13 dBm
- Phase Noise: -116 dBc/Hz @100 kHz Typ.
- No External Resonator Needed
- 32 Lead 5x5mm SMT Package: 25mm²

Functional Diagram

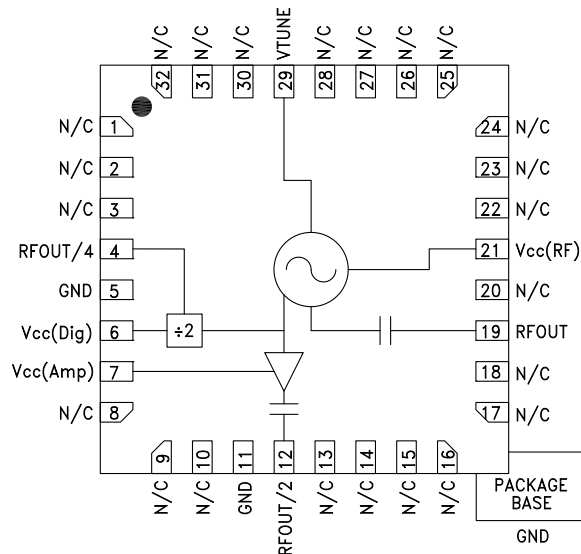

General Description

The HMC510LP5 & HMC510LP5E are GaAs InGaP Heterojunction Bipolar Transistor (HBT) MMIC VCOs. The HMC510LP5 & HMC510LP5E integrate resonators, negative resistance devices, varactor diodes and feature half frequency and divide-by-4 outputs. The VCO's phase noise performance is excellent over temperature, shock, and process due to the oscillator's monolithic structure. Power output is +13 dBm typical from a +5V supply voltage. The prescaler and RF/2 functions can be disabled to conserve current if not required. The voltage controlled oscillator is packaged in a leadless QFN 5x5 mm surface mount package, and requires no external matching components.

Electrical Specifications, $T_A = +25^\circ C$, $V_{cc} (Dig)$, $V_{cc} (Amp)$, $V_{cc} (RF) = +5V$

| Parameter | Min. | Typ. | Max. | Units | |
|---|--|------------------------------|------------------|-------------------|----|
| Frequency Range | F_o $F_o/2$ | 8.45 - 9.55 4.225 - 4.775 | | GHz GHz | |
| Power Output | RFOUT RFOUT/2 RFOUT/4 | +10 +8 -8 | +15 +14 -4 | dBm dBm dBm | |
| SSB Phase Noise @ 100 kHz Offset, Vtune= +5V @ RFOUT | | -116 | | dBc/Hz | |
| Tune Voltage | Vtune | 2 | 13 | V | |
| Supply Current | $I_{cc}(Dig) + I_{cc}(Amp) + I_{cc}(RF)$ | 270 | 315 | 360 | mA |
| Tune Port Leakage Current (Vtune= 13V) | | | 10 | μA | |
| Output Return Loss | | 2 | | dB | |
| Harmonics/Subharmonics | 1/2 2nd 3rd | | 40 15 40 | dBc dBc dBc | |
| Pulling (into a 2.0:1 VSWR) | | 6 | | MHz/pp | |
| Pushing @ Vtune= 5V | | 20 | | MHz/V | |
| Frequency Drift Rate | | 0.8 | | MHz/ $^\circ C$ | |

For price, delivery and to place orders: Hittite Microwave Corporation, 20 Alpha Road, Chelmsford, MA 01824

Phone: 978-250-3343 Fax: 978-250-3373 Order On-line at www.hittite.com

Application Support Phone: 978-250-3343 or apps@hittite.com



MICROWAVE CORPORATION v04.0811



HMC510LP5 / 510LP5E

MMIC VCO w/ HALF FREQUENCY OUTPUT & DIVIDE-BY-4, 8.45 - 9.55 GHz

Frequency vs. Tuning Voltage, Vcc = +5V

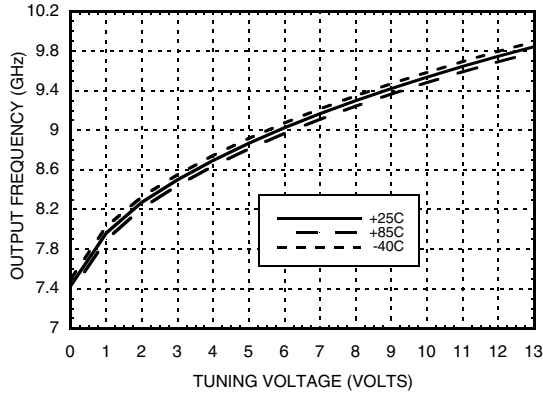

Frequency vs. Tuning Voltage, T= 25°C

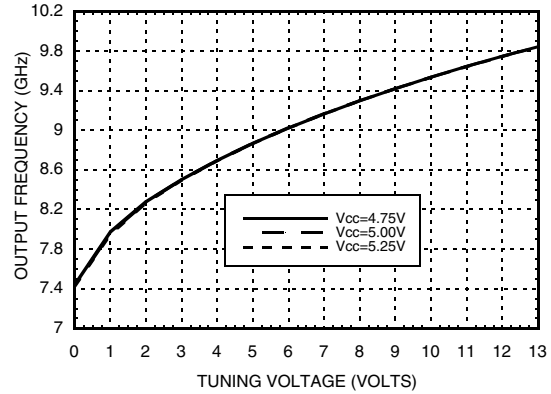

Sensitivity vs. Tuning Voltage, Vcc = +5V

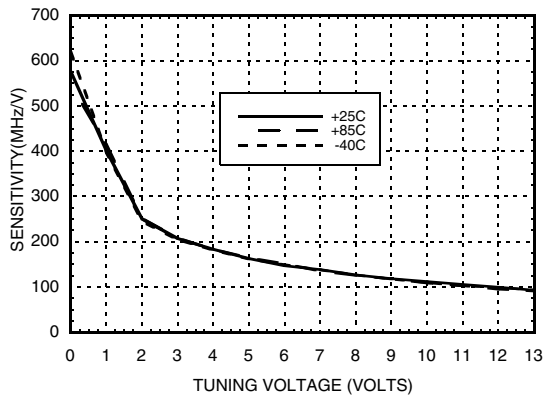

Output Power vs. Tuning Voltage, Vcc = +5V

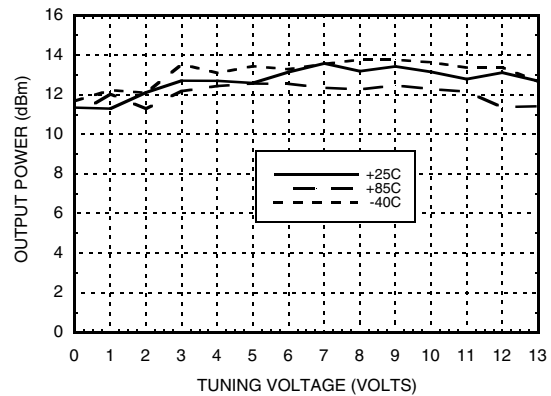

SSB Phase Noise vs. Tuning Voltage

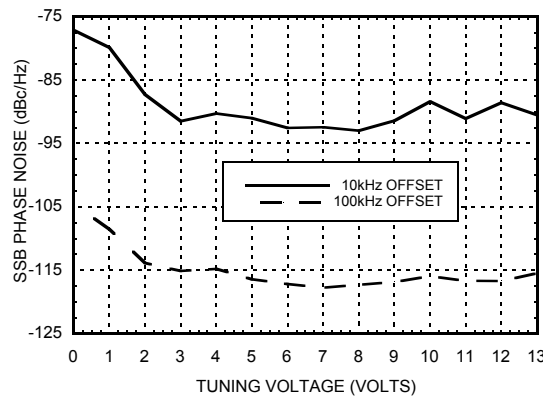

SSB Phase Noise @ Vtune = +5V

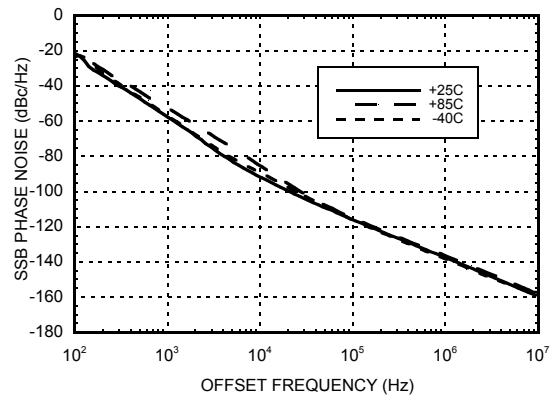

For price, delivery and to place orders: Hittite Microwave Corporation, 20 Alpha Road, Chelmsford, MA 01824
Phone: 978-250-3343 Fax: 978-250-3373 Order On-line at www.hittite.com

www.BDTIC.com/Hittite/



MMIC VCO w/ HALF FREQUENCY OUTPUT & DIVIDE-BY-4, 8.45 - 9.55 GHz

RFOUT/2 Frequency vs. Tuning Voltage, Vcc = +5V

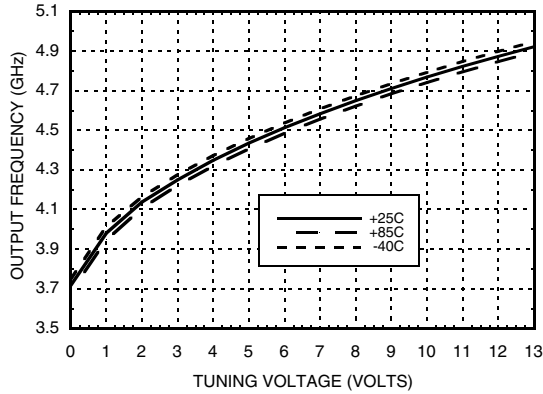

RFOUT/2 Output Power vs. Tuning Voltage, Vcc = +5V

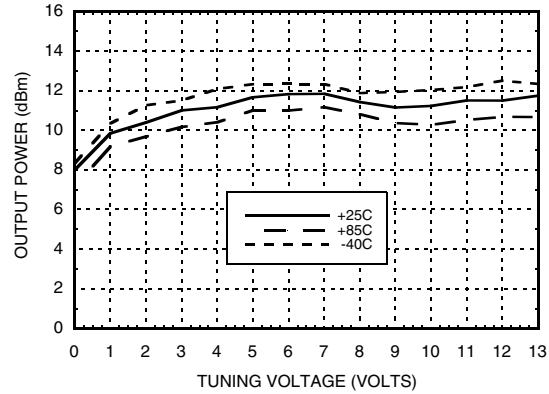

Divide-by-4 Frequency vs. Tuning Voltage, Vcc = +5V

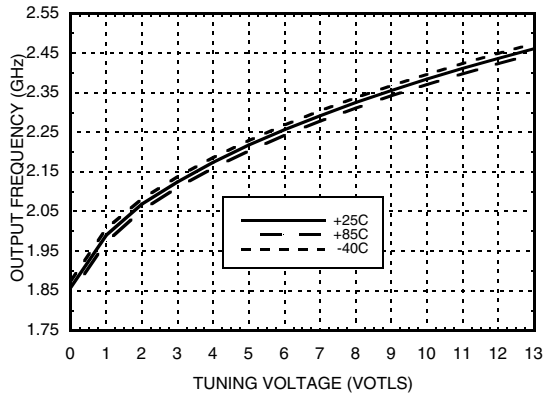

Divide-by-4 Output Power vs. Tuning Voltage, Vcc = +5V

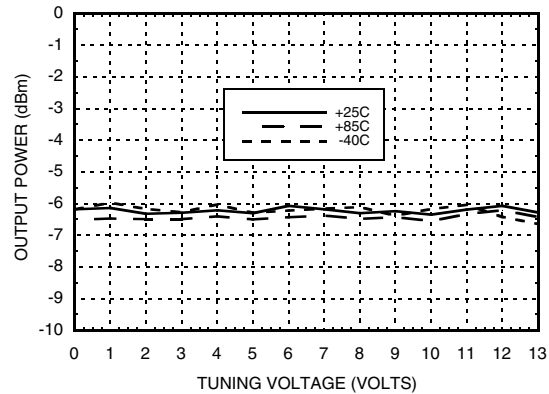

Absolute Maximum Ratings

| | |
|--|----------------|
| Vcc(Dig), Vcc(Amp), Vcc(RF) | +5.5 Vdc |
| Vtune | 0 to +15V |
| Junction Temperature | 135 °C |
| Continuous P _{diss} (T=85 °C) (derate 43.5 mW/C above 85 °C) | 2.17 W |
| Thermal Resistance (junction to ground paddle) | 23 °C/W |
| Storage Temperature | -65 to +150 °C |
| Operating Temperature | -40 to +85 °C |
| ESD Sensitivity (HBM) | Class 1A |

Typical Supply Current vs. Vcc

| Vcc (V) | I _{cc} (mA) |
|---------|----------------------|
| 4.75 | 290 |
| 5.00 | 315 |
| 5.25 | 340 |

Note: VCO will operate over full voltage range shown above.



**ELECTROSTATIC SENSITIVE DEVICE
OBSERVE HANDLING PRECAUTIONS**



MMIC VCO w/ HALF FREQUENCY OUTPUT & DIVIDE-BY-4, 8.45 - 9.55 GHz

Outline Drawing

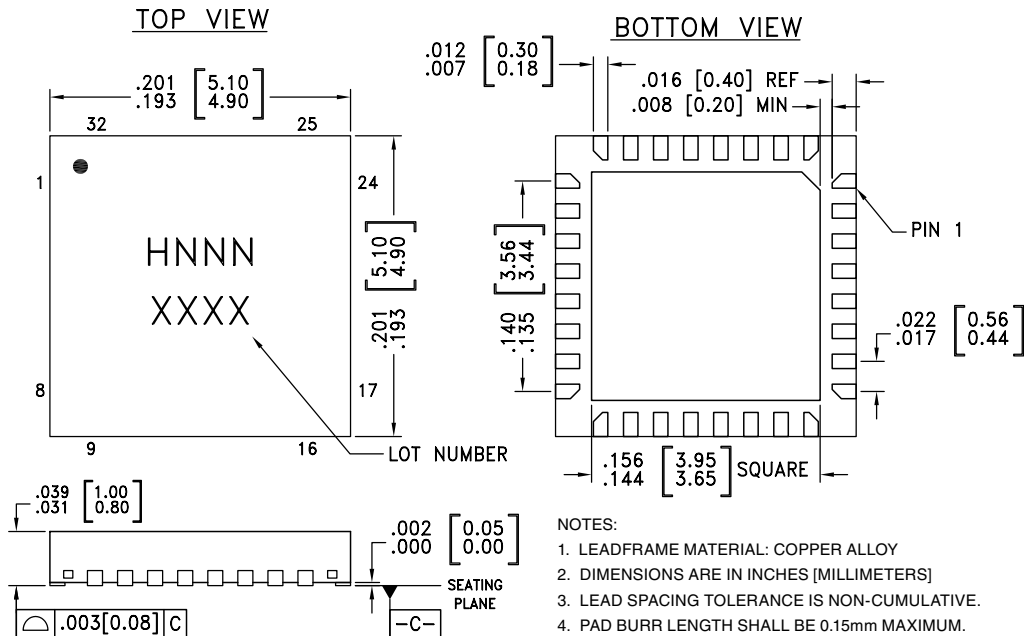

- NOTES:
- LEADFRAME MATERIAL: COPPER ALLOY
 - DIMENSIONS ARE IN INCHES [MILLIMETERS]
 - LEAD SPACING TOLERANCE IS NON-CUMULATIVE.
 - PAD BURR LENGTH SHALL BE 0.15mm MAXIMUM. PAD BURR HEIGHT SHALL BE 0.05mm MAXIMUM.
 - PACKAGE WARP SHALL NOT EXCEED 0.05mm.
 - ALL GROUND LEADS AND GROUND PADDLE MUST BE SOLDERED TO PCB RF GROUND.
 - REFER TO HITTITE APPLICATION NOTE FOR SUGGESTED LAND PATTERN.

Package Information

| Part Number | Package Body Material | Lead Finish | MSL Rating | Package Marking ^[3] |
|-------------|--|---------------|---------------------|--------------------------------|
| HMC510LP5 | Low Stress Injection Molded Plastic | Sn/Pb Solder | MSL3 ^[1] | H510 XXXX |
| HMC510LP5E | RoHS-compliant Low Stress Injection Molded Plastic | 100% matte Sn | MSL3 ^[2] | H510 XXXX |

[1] Max peak reflow temperature of 235 °C
 [2] Max peak reflow temperature of 260 °C
 [3] 4-Digit lot number XXXX

Pin Descriptions

| Pin Number | Function | Description | Interface Schematic |
|------------------------------------|-----------|---|---------------------|
| 1-3, 8-10, 13-18, 20, 22-28, 30-32 | N/C | No Connection. These pins may be connected to RF/DC ground. Performance will not be affected. | |
| 4 | RFOUT/4 | Divide-by-4 output. DC block required. | |
| 6 | Vcc (Dig) | Supply voltage for prescaler. If prescaler is not required, this pin may be left open to conserve approximately 65 mA of current. | |

For price, delivery and to place orders: Hittite Microwave Corporation, 20 Alpha Road, Chelmsford, MA 01824
 Phone: 978-250-3343 Fax: 978-250-3373 Order On-line at www.hittite.com



**MMIC VCO w/ HALF FREQUENCY OUTPUT
& DIVIDE-BY-4, 8.45 - 9.55 GHz**

Pin Descriptions

| Pin Number | Function | Description | Interface Schematic |
|---------------|-----------|---|---------------------|
| 7 | Vcc (Amp) | Supply voltage, for RFOUT/2 output. If RFOUT/2 is not required, this pin may be left open to conserve approximately 30 mA of current. | |
| 12 | RFOUT/2 | Half frequency output (AC coupled). | |
| 19 | RF OUT | RF output (AC coupled). | |
| 21 | Vcc (RF) | Supply Voltage, +5V | |
| 29 | VTUNE | Control voltage and modulation input. Modulation bandwidth dependent on drive source impedance. See "Determining the FM Bandwidth of a Wideband Varactor Tuned VCO" application note. | |
| 5, 11, Paddle | GND | Package bottom has an exposed metal paddle that must be connected to RF/DC ground. | |

Typical Application Circuit

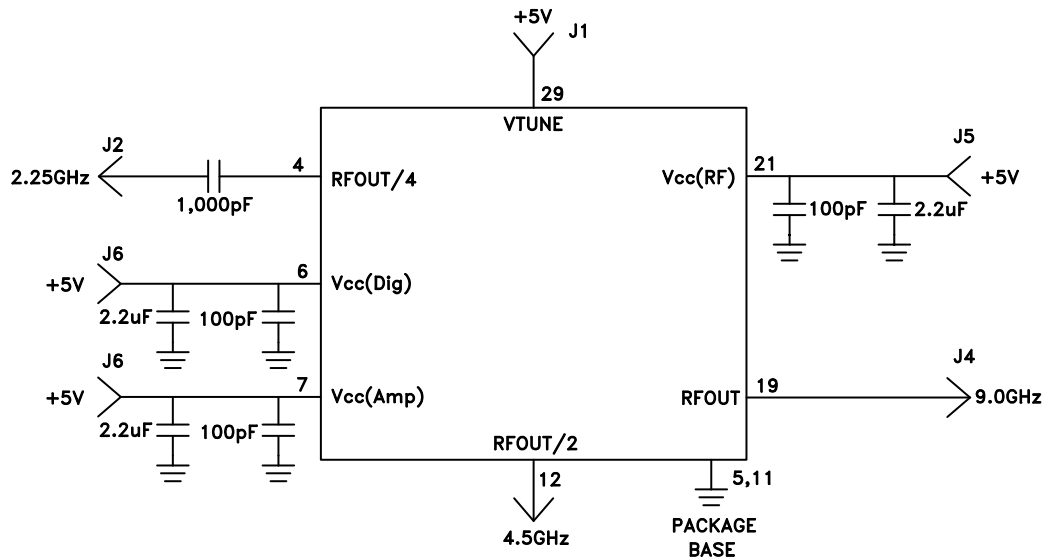

For price, delivery and to place orders: Hittite Microwave Corporation, 20 Alpha Road, Chelmsford, MA 01824
 Phone: 978-250-3343 Fax: 978-250-3373 Order On-line at www.hittite.com



Evaluation PCB

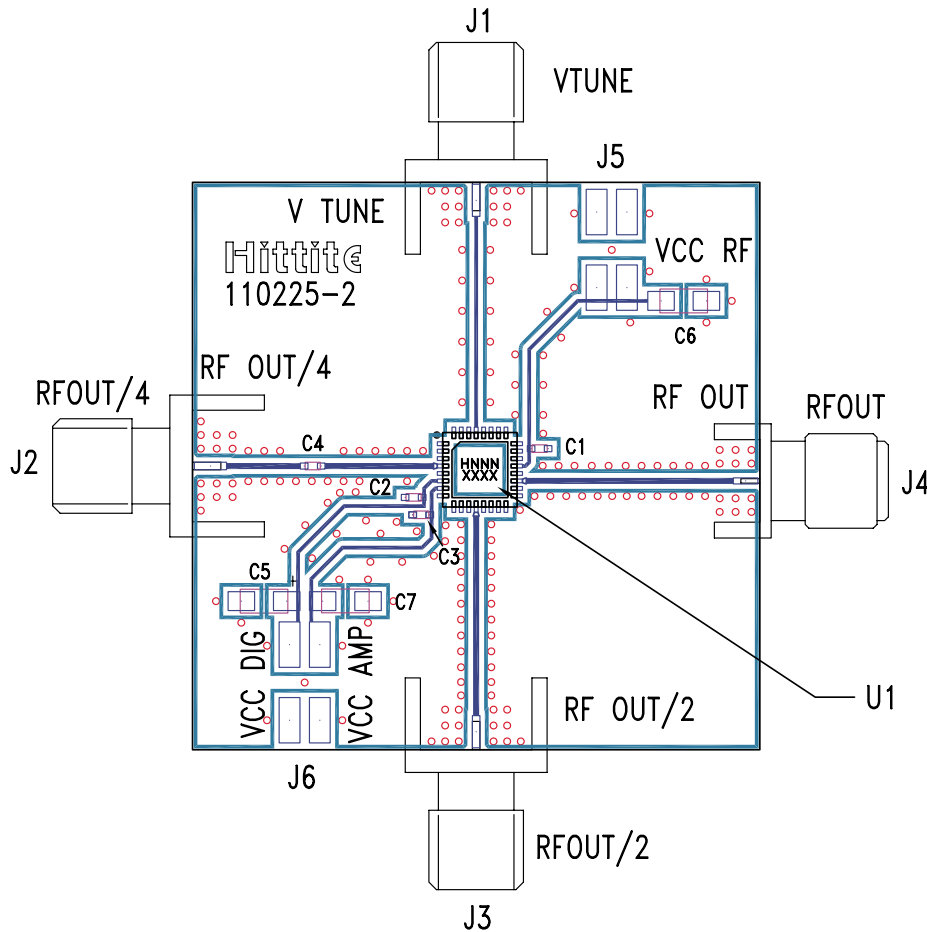

List of Materials for Evaluation PCB 110227 [1]

| Item | Description |
|---------|--------------------------------|
| J1 - J4 | PCB Mount SMA RF Connector |
| J5 - J6 | 2 mm DC Header |
| C1 - C3 | 100 pF Capacitor, 0402 Pkg. |
| C4 | 1,000 pF Capacitor, 0402 Pkg. |
| C5 - C7 | 2.2 μ F Tantalum Capacitor |
| U1 | HMC510LP5 / HMC510LP5E VCO |
| PCB [2] | 110225 Eval Board |

[1] Reference this number when ordering complete evaluation PCB

[2] Circuit Board Material: Rogers 4350

The circuit board used in the application should use RF circuit design techniques. Signal lines should have 50 Ohm impedance while the package ground leads and backside ground paddle should be connected directly to the ground plane similar to that shown. A sufficient number of via holes should be used to connect the top and bottom ground planes. The evaluation circuit board shown is available from Hittite upon request.