

Typical Applications

The HMC538LP4 / HMC538LP4E is ideal for:

- Fiber Optics
- Military
- Test Equipment

Features

- Available as Lead Free
- Wide Bandwidth: 6 - 15 GHz
- >600° Phase Shift
- Single Positive Voltage Control
- QFN Leadless SMT Package, 16 mm²

Functional Diagram

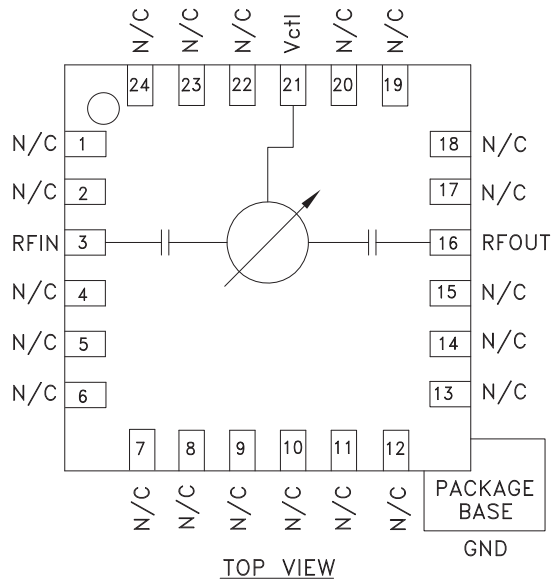

General Description

The HMC538LP4(E) are Analog Phase Shifters which are controlled via an analog control voltage from 0 to +5V. The HMC538LP4(E) provides a continuously variable phase shift of 0 to 800 degrees at 6 GHz, and 0 to 450 degrees at 16 GHz, with consistent insertion loss versus phase shift. The phase shift is monotonic with respect to control voltage. The control port has a modulation bandwidth of 50 MHz. The low insertion loss and compact size enable this part to be used in a wide range of applications, including the phase adjustment of clocks in fiber optic systems and test equipment. The HMC538LP4(E) is housed in leadless QFN surface mount packages and are available in both standard and RoHS compliant versions.

Electrical Specifications, $T_A = +25^\circ\text{C}$, 50 Ohm System

Parameter	Frequency (GHz)	Min.	Typ.	Max.	Units
Phase Shift Range	6 - 10 GHz	600	800		degrees
	10 - 15 GHz	360	600		degrees
Insertion Loss	6 - 15 GHz		8	11	dB
Return Loss (Input and Output)	6 - 15 GHz		7		dB
Control Voltage Range	6 - 15 GHz		0 - 5		Volt
Modulation Bandwidth	6 - 15 GHz		50		MHz
Phase Voltage Sensitivity	6 - 15 GHz		120		deg / Volt
Insertion Phase Temperature Sensitivity	6 - 15 GHz		0.5		deg / °C

**600° ANALOG PHASE SHIFTER,
6 - 15 GHz**

Insertion Loss vs. Control Voltage @ 11 GHz

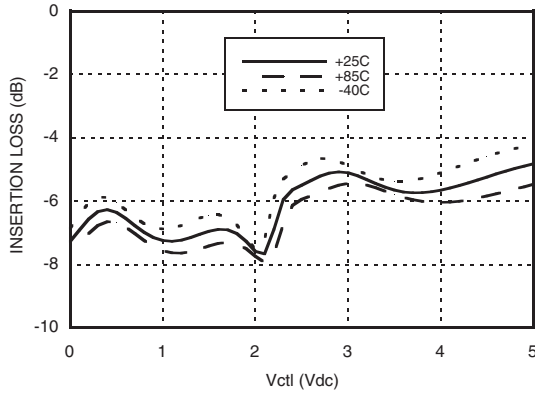

Phase Shift vs. Control Voltage

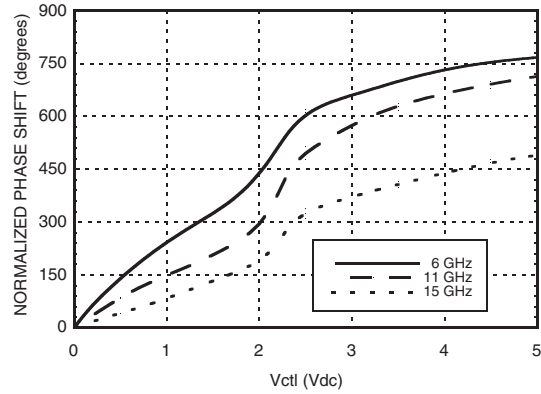

**Phase Shift vs. Frequency @ Vctl = 5V
(Relative to Vctl = 0V)**

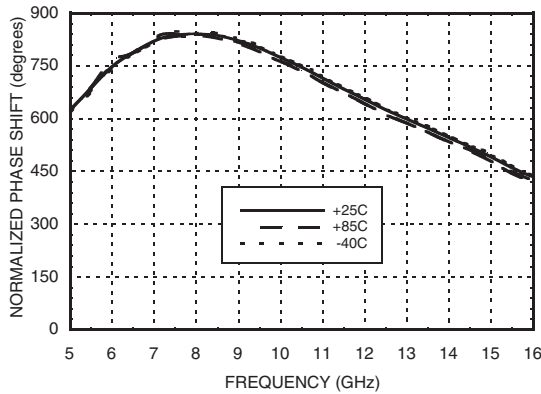

Insertion Loss vs. Frequency

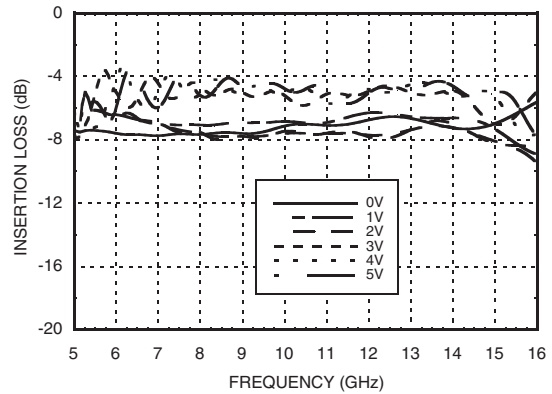

**Input Return Loss vs. Frequency,
Vctl = 0 to +5V**

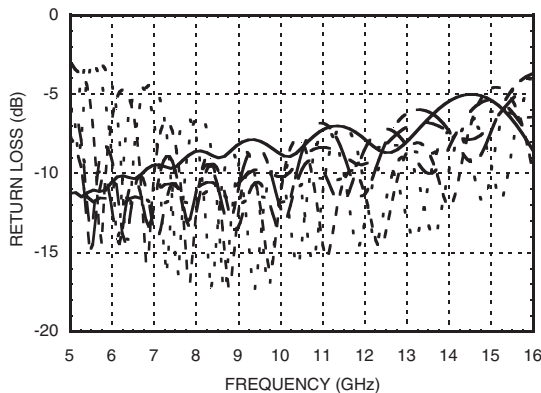

**Output Return Loss vs. Frequency,
Vctl = 0 to +5V**

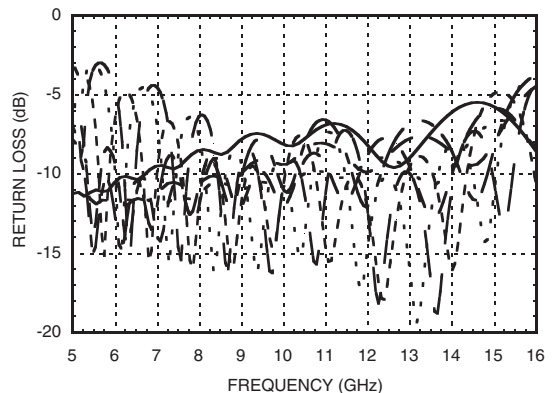

600° ANALOG PHASE SHIFTER, 6 - 15 GHz

**Second Harmonics vs. Control Voltage,
Pin = -10 dBm**

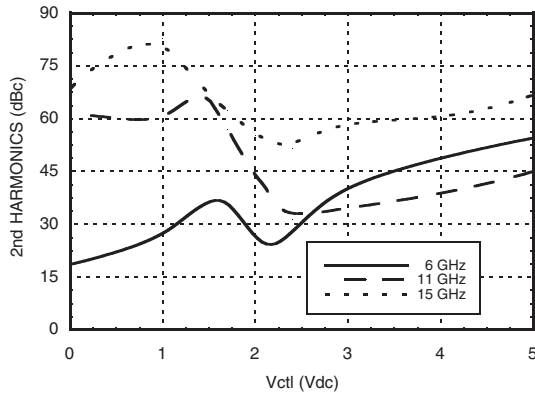

Input IP3 vs. Control Voltage

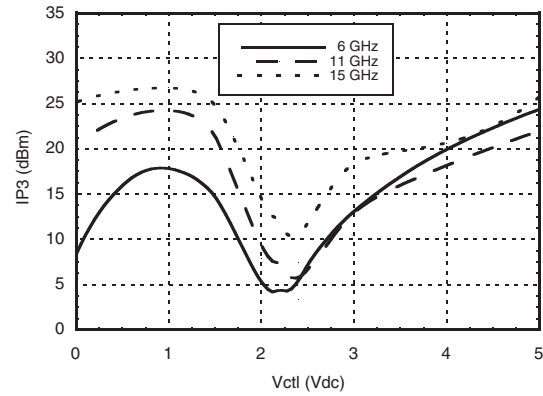

Insertion Loss vs. Pin @ 7 GHz

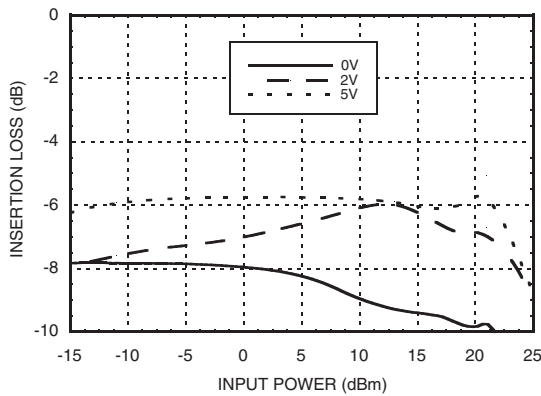

Insertion Loss vs. Pin @ 11 GHz

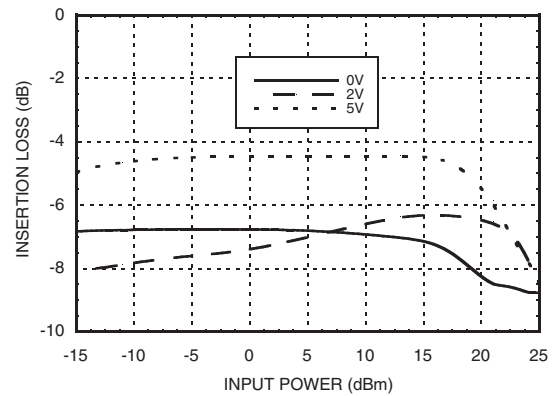

Insertion Loss vs. Pin @ 15 GHz

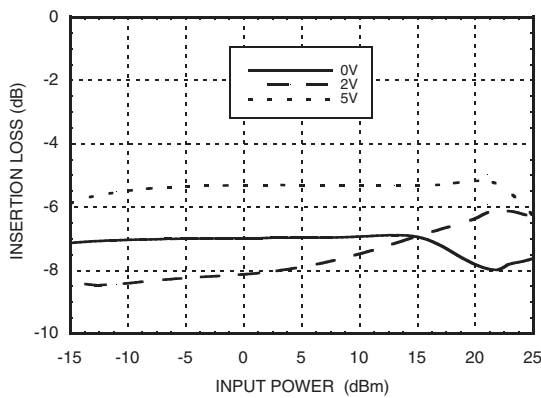

Phase Shift vs. Pin @ 7 GHz

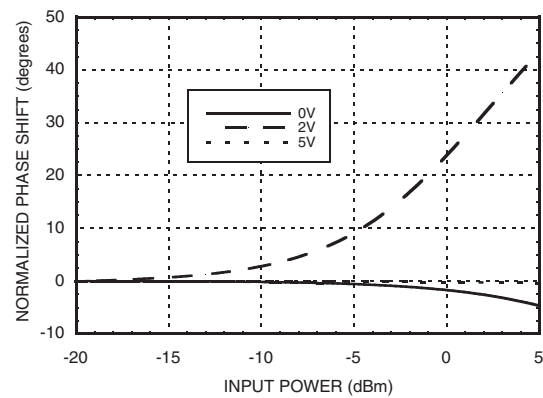

10

PHASE SHIFTERS - ANALOG - SMT

Phase Shift vs. Pin @ 11 GHz

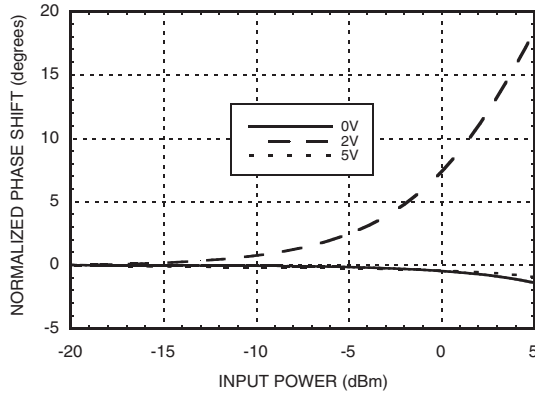

Phase Shift vs. Pin @ 15 GHz

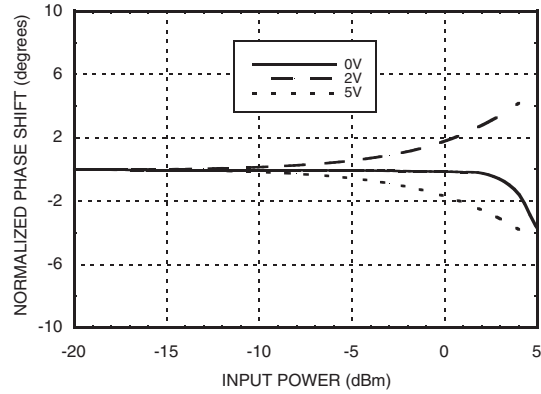

Absolute Maximum Ratings

Control Voltage (Vctl)	-1 Vdc to + 8 Vdc
Input Power (RFin)	+25 dBm
Channel Temperature (Tc)	150 °C
Continuous Pdiss (T = 85 °C) (derate 21 mW/°C above 85 °C)	1.36 W
Thermal Resistance (junction to ground paddle)	48 °C/W
Storage Temperature	-65 to +150 °C
Operating Temperature	-40 to +85 °C
ESD Sensitivity (HBM)	Class 1A



**ELECTROSTATIC SENSITIVE DEVICE
OBSERVE HANDLING PRECAUTIONS**

Outline Drawing

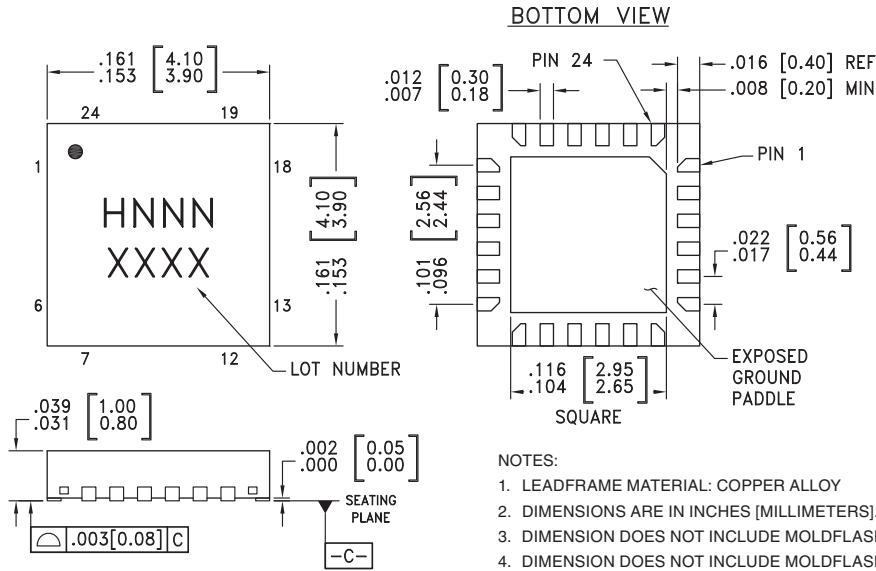

NOTES:

1. LEADFRAME MATERIAL: COPPER ALLOY
2. DIMENSIONS ARE IN INCHES [MILLIMETERS].
3. DIMENSION DOES NOT INCLUDE MOLDFLASH OF 0.15mm PER SIDE.
4. DIMENSION DOES NOT INCLUDE MOLDFLASH OF 0.25mm PER SIDE.
5. ALL GROUND LEADS MUST BE SOLDERED TO PCB RF GROUND.
6. CLASSIFIED AS MOISTURE SENSITIVITY LEVEL (MSL) 1.

Package Information

Part Number	Package Body Material	Lead Finish	MSL Rating	Package Marking ^[3]
HMC538LP4	Low Stress Injection Molded Plastic	Sn/Pb Solder	MSL1 ^[1]	H538 XXXX
HMC538LP4E	RoHS-compliant Low Stress Injection Molded Plastic	100% matte Sn	MSL1 ^[2]	H538 XXXX

[1] Max peak reflow temperature of 235 °C

[2] Max peak reflow temperature of 260 °C

[3] 4-Digit lot number XXXX

Pin Descriptions

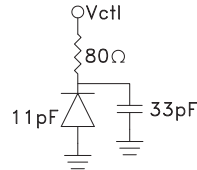
Pin Number	Function	Description	Interface Schematic
1, 2, 4-15, 17-20, 22-24	N/C	No connection required. These pins may be connected to RF/DC ground without affecting performance.	
3	RFIN	Port is DC blocked.	RFIN ○ — —
16	RFOUT	Port is DC blocked.	— — ○ RFOUT
21	Vctl	Phase shift control pin. Application of a voltage between 0 and 5 volts causes the transmission phase to change. The DC equivalent circuit is a series connected diode and resistor.	
	GND	Ground: Backside of package has exposed metal ground slug that must be connected to ground thru a short path. Vias under the device are required.	○ GND

For price, delivery, and to place orders, please contact Hittite Microwave Corporation:
20 Alpha Road, Chelmsford, MA 01824 Phone: 978-250-3343 Fax: 978-250-3373

Order On-Line at www.hittite.com
www.BDTC.com/Hittite/

Evaluation PCB

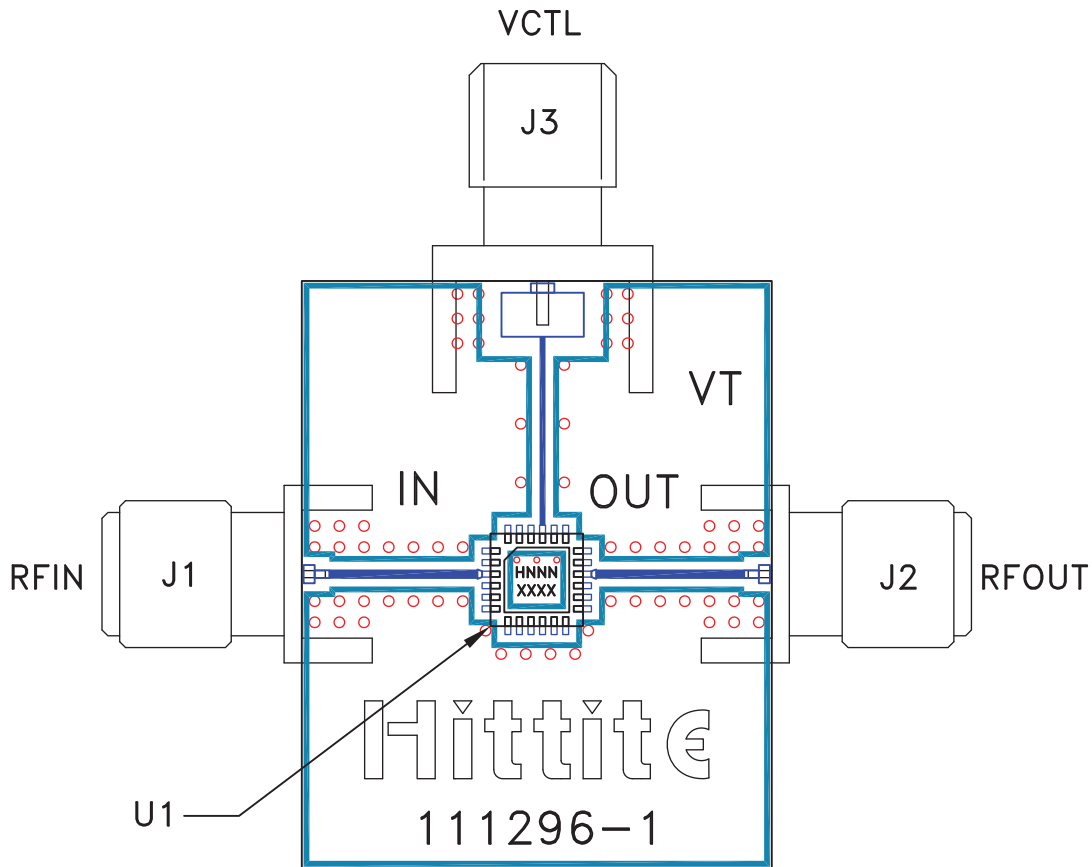

List of Materials for Evaluation PCB 108812 [1]

Item	Description
J1 - J3	PCB Mount SMA RF Connector
U1	HMC538LP4 / HMC538LP4E Analog Phase Shifter
PCB [2]	111296 Evaluation PCB

[1] Reference this number when ordering complete evaluation PCB

[2] Circuit Board Material: Rogers 4350

The circuit board used in the final application should use RF circuit design techniques. Signal lines should have 50 ohm impedance while the package ground leads and exposed paddle should be connected directly to the ground plane similar to that shown. A sufficient number of via holes should be used to connect the top and bottom ground planes. The evaluation board should be mounted to an appropriate heat sink. The evaluation circuit board shown is available from Hittite upon request.