

Typical Applications

The HMC644LC5 is ideal for:

- EW Receivers
- Weather & Military Radar
- Satellite Communications
- Beamforming Modules
- Phase Cancellation

Features

- Low RMS Phase Error: 3.5°
- Low Insertion Loss: 7.5 dB
- High Linearity: +40 dBm
- 360° Coverage, LSB = 11.25°
- 32 Lead Ceramic SMT Package: 25mm²

Functional Diagram

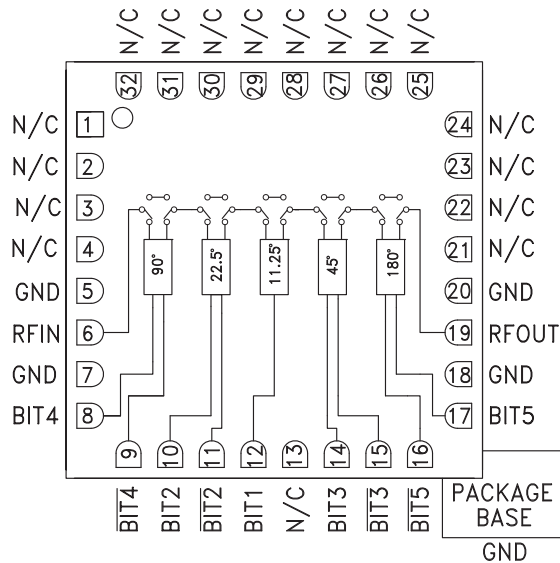

General Description

The HMC644LC5 is a 5-bit digital phase shifter which is rated from 15 to 18.5 GHz, providing 360 degrees of phase coverage, with a LSB of 11.25 degrees. The HMC644LC5 features very low RMS phase error of 3.5 degrees and extremely low insertion loss variation of ±0.5 dB across all phase states. This high accuracy phase shifter is controlled with complementary logic of 0/-3V, and requires no fixed bias voltage. The HMC644LC5 is housed in a compact 5x5 mm ceramic leadless SMT package and is internally matched to 50 Ohms with no external components. Simple external level shifting circuitry can be used to convert a positive CMOS control voltage into complementary negative control signals.

Electrical Specifications, $T_A = +25^\circ C$, 50 Ohm System, Control Voltage = 0/-3V

Parameter	Min.	Typ.	Max.	Units
Frequency Range	15		18.5	GHz
Insertion Loss*		7.5	10	dB
Input Return Loss*		10		dB
Output Return Loss*		12		dB
Phase Error*		±5	+20 / -10	deg
RMS Phase Error		3.5		deg
Insertion Loss Variation*		±0.5		dB
Input Power for 1 dB Compression		23		dBm
Input Third Order Intercept		40		dBm
Control Voltage Current		<1		mA

*Note: Major States Shown



GaAs MMIC 5-BIT DIGITAL PHASE SHIFTER, 15 - 18.5 GHz

Insertion Loss, Major States Only

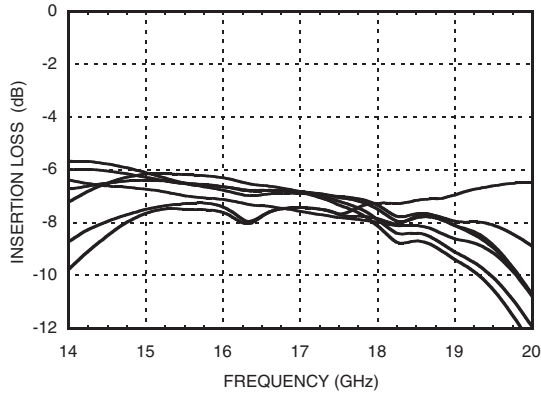

Normalized Loss, Major States Only

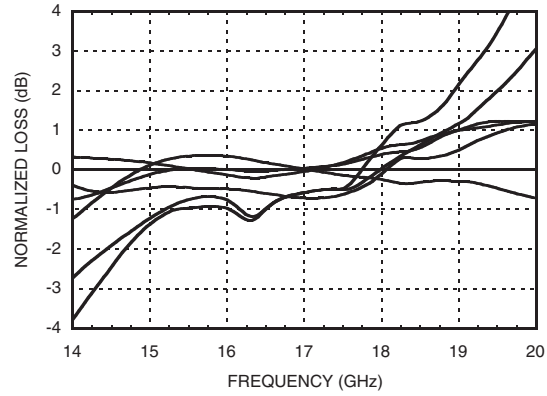

Input Return Loss, Major States Only

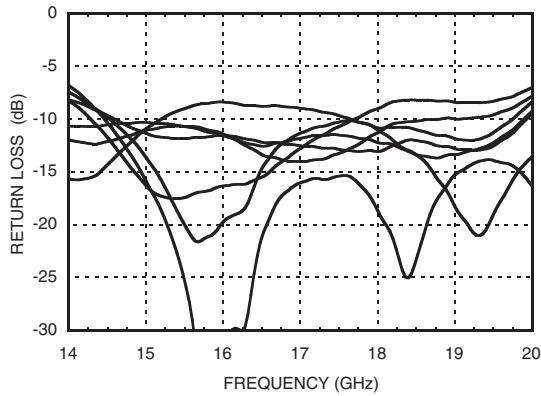

Phase Error, Major States Only

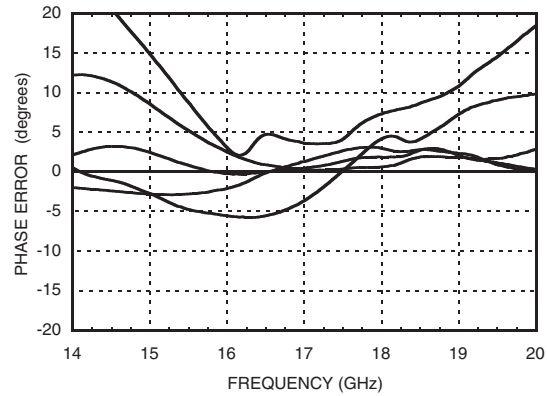

Output Return Loss, Major States Only

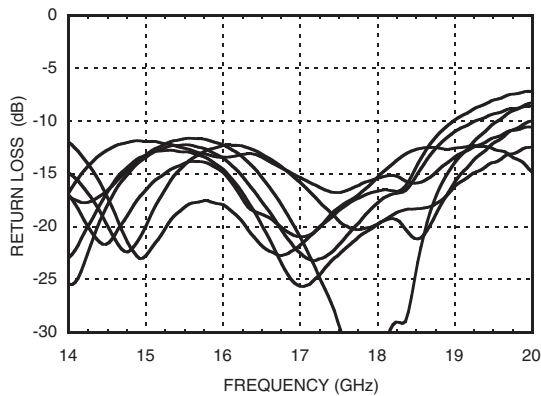

Relative Phase Shift Major States Including All Bits

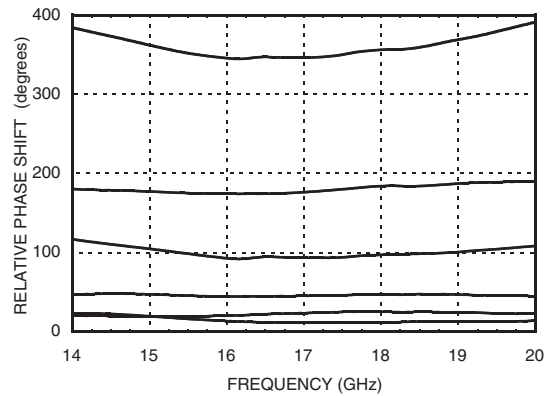

10

PHASE SHIFTERS - DIGITAL - SMT

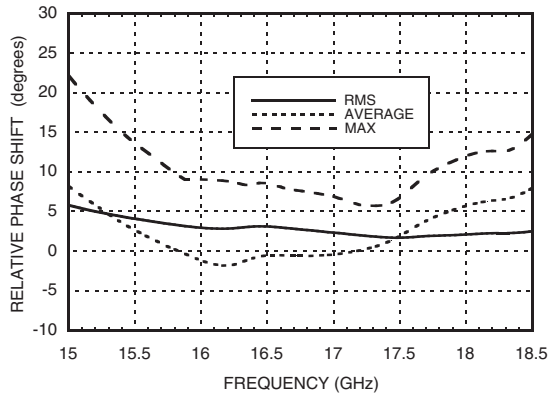
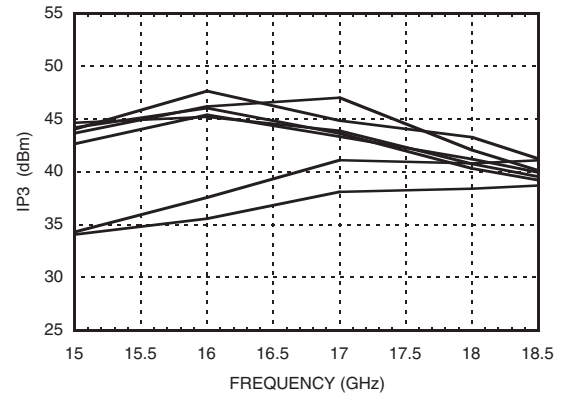
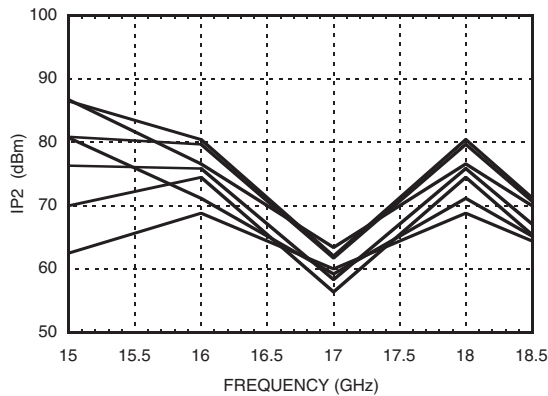
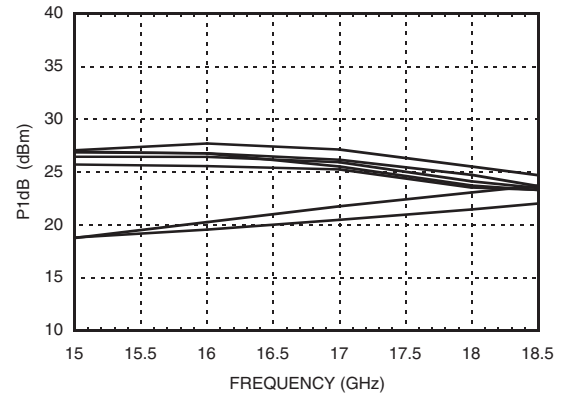
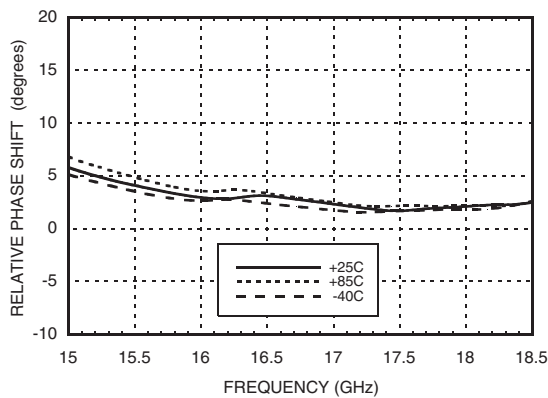
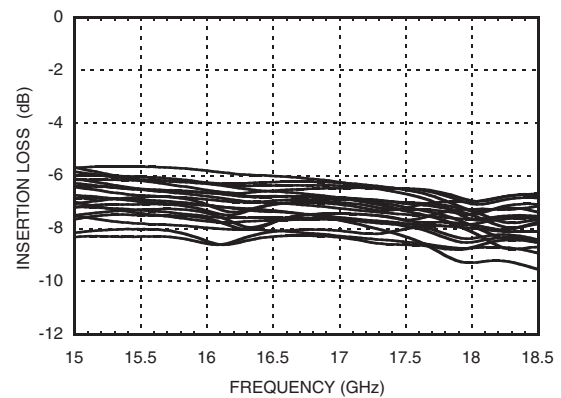
**GaAs MMIC 5-BIT DIGITAL
PHASE SHIFTER, 15 - 18.5 GHz**
**Relative Phase Shift,
RMS, Average, Max, All States**

Input IP3, Major States Only

Input IP2, Major States Only

Input P1dB, Major States Only

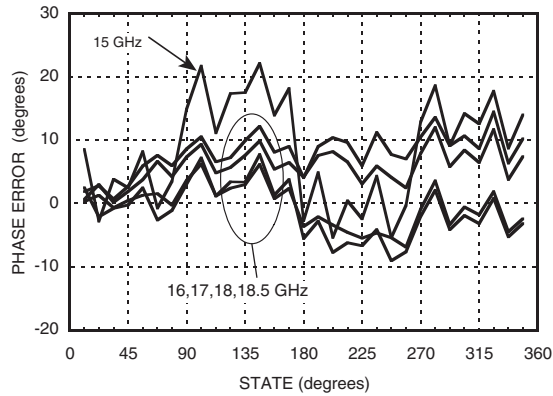
RMS Phase Error vs. Temperature

**Insertion Loss vs. Temperature,
Major States Only**



GaAs MMIC 5-BIT DIGITAL PHASE SHIFTER, 15 - 18.5 GHz

Phase Error vs. State, Major States Only



Absolute Maximum Ratings

Input Power (RFIN)	26 dBm (T= +85 °C)
Channel Temperature (Tc)	150 °C
Thermal Resistance (channel to ground paddle)	150 °C/W
Storage Temperature	-65 to +150 °C
Operating Temperature	-40 to +85 °C

Control Voltage

State	Bias Condition
Low (0)	-2.5 to -3.5V @ 0.4 µA Typ.
High (1)	0 to +0.3V @ 0.4 µA Typ.



ELECTROSTATIC SENSITIVE DEVICE
OBSERVE HANDLING PRECAUTIONS

Truth Table

Control Voltage Input									Phase Shift (Degrees) RFIN - RFOUT
Bit 1	Bit 2	$\overline{\text{Bit 2}}$	Bit 3	$\overline{\text{Bit 3}}$	Bit 4	$\overline{\text{Bit 4}}$	Bit 5	$\overline{\text{Bit 5}}$	
0	0	1	0	1	0	1	0	1	Reference*
1	0	1	0	1	0	1	0	1	11.25
0	1	0	0	1	0	1	0	1	22.5
0	0	1	1	0	0	1	0	1	45.0
0	0	1	0	1	1	0	0	1	90.0
0	0	1	0	1	0	1	1	0	180.0
1	1	0	1	0	1	0	1	0	348.75

Any combination of the above states will provide a phase shift approximately equal to the sum of the bits selected.

*Reference corresponds to monotonic setting

10

PHASE SHIFTERS - DIGITAL - SMT

GaAs MMIC 5-BIT DIGITAL PHASE SHIFTER, 15 - 18.5 GHz

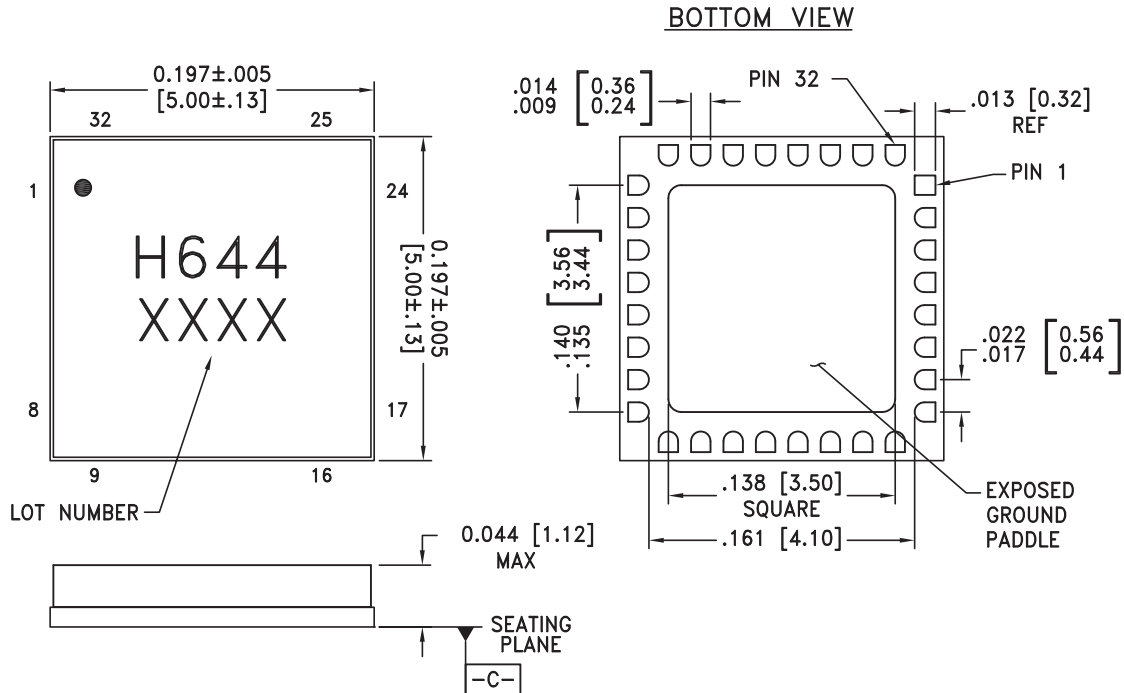

Outline Drawing



NOTES:

1. PACKAGE BODY MATERIAL: ALUMINA
2. LEAD AND GROUND PADDLE PLATING: 30-80 MICROINCHES GOLD OVER 50 MICROINCHES MINIMUM NICKEL.
3. DIMENSIONS ARE IN INCHES [MILLIMETERS].
4. LEAD SPACING TOLERANCE IS NON-CUMULATIVE
5. PACKAGE WARP SHALL NOT EXCEED 0.05mm DATUM **-C-**
6. ALL GROUND LEADS AND GROUND PADDLE MUST BE SOLDERED TO PCB RF GROUND.
7. CLASSIFIED AS MOISTURE SENSITIVITY LEVEL (MSL) 1.

Pin Descriptions

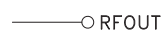
Pin Number	Function	Description	Interface Schematic
1 - 4, 13 21 - 32	N/C	No connection required. These pins may be connected to RF/DC ground without affecting performance.	
5, 7, 18, 20	GND	These pins and exposed ground paddle must be connected to RF/DC ground.	
6	RFIN	This port is DC coupled and matched to 50 Ohms.	RFIN 
8, 10, 12, 14, 17	BIT4, BIT2, BIT1, BIT3, BIT5	Non-Inverted Control Input. See truth table and control voltage tables.	
9, 11, 15, 16	$\overline{\text{BIT4}}, \overline{\text{BIT2}}$ $\overline{\text{BIT3}}, \overline{\text{BIT5}}$	Inverted Control Input. See truth table and control voltage tables.	
19	RFOUT	This port is DC coupled and matched to 50 Ohms.	



GaAs MMIC 5-BIT DIGITAL PHASE SHIFTER, 15 - 18.5 GHz

Application Circuit

This circuit converts a single line positive (0/+5V) control signal to complementary negative (0/-3V) control signals.

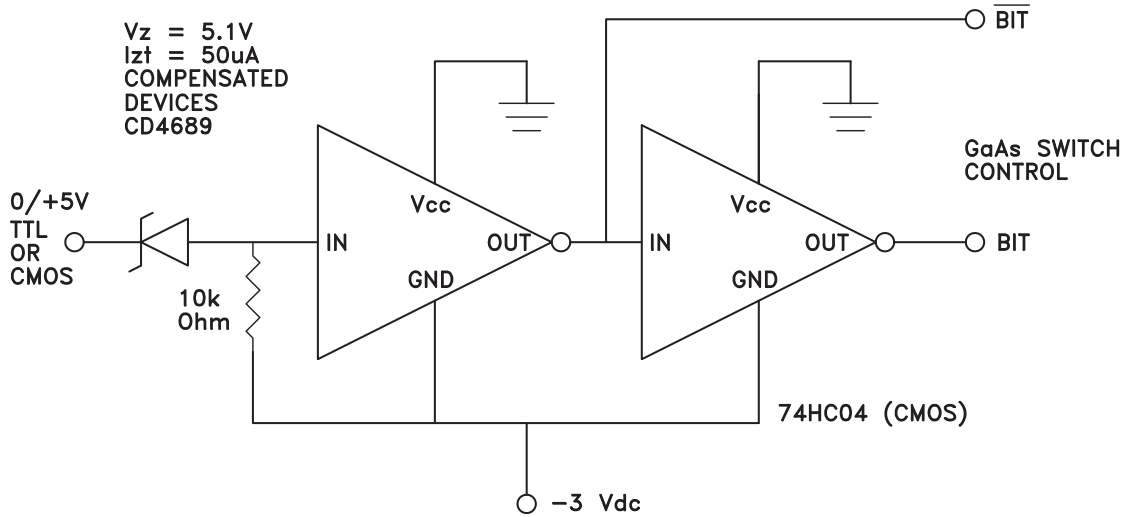

10

PHASE SHIFTERS - DIGITAL - SMT

Evaluation PCB

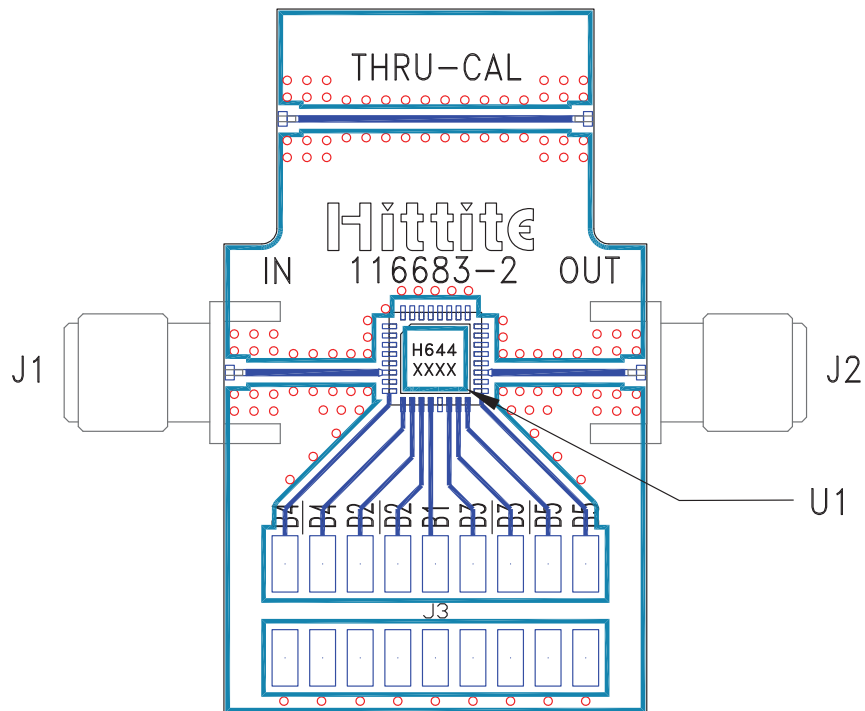

10

PHASE SHIFTERS - DIGITAL - SMT

List of Materials for Evaluation PCB 116685 [1][3]

Item	Description
J1 - J2	PCB Mount SMA RF Connector
J3	Molex Header 2mm
U1	HMC644LC5 5-Bit Digital Phase Shifter
PCB [2]	116683 Evaluation PCB

[1] Reference this number when ordering complete evaluation PCB
 [2] Circuit Board Material: Rogers 4350
 [3] Please refer to part's pin description and functional diagram for pin out assignments on evaluation board.

The circuit board used in the final application should use RF circuit design techniques. Signal lines should have 50 ohm impedance while the package ground leads and exposed paddle should be connected directly to the ground plane similar to that shown. A sufficient number of via holes should be used to connect the top and bottom ground planes. The evaluation board should be mounted to an appropriate heat sink. The evaluation circuit board shown is available from Hittite upon request.