



HMC717LP3 / 717LP3E

GaAs PHEMT MMIC LOW NOISE AMPLIFIER, 4.8 - 6.0 GHz

Typical Applications

The HMC717LP3(E) is ideal for:

- Fixed Wireless and LTE/WiMAX/4G
- BTS & Infrastructure
- Repeaters and Femtocells
- Public Safety Radio
- Access Points

Features

- Noise Figure: 1.1 dB
- Gain: 16.5 dB
- Output IP3: +31.5 dBm
- Single Supply: +3V to +5V
- 16 Lead 3x3mm QFN Package: 9 mm²

Functional Diagram

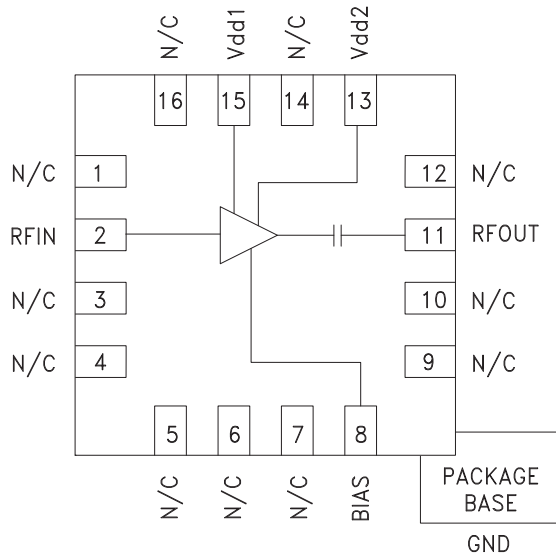

General Description

The HMC717LP3(E) is a GaAs PHEMT MMIC Low Noise Amplifier that is ideal for fixed wireless and LTE/WiMAX/4G basestation front-end receivers operating between 4.8 and 6.0 GHz. The amplifier has been optimized to provide 1.1 dB noise figure, 16.5 dB gain and +31.5 dBm output IP3 from a single supply of +5V. Input and output return losses are excellent and the LNA requires minimal external matching and bias decoupling components. The HMC717LP3(E) can be biased with +3V to +5V and features an externally adjustable supply current which allows the designer to tailor the linearity performance of the LNA for each application.

Electrical Specifications

$T_A = +25^\circ C$, $R_{bias} = 2k\ \text{Ohms}$ for $V_{dd} = 5V$, $R_{bias} = 20k\ \text{Ohms}$ for $V_{dd} = 3V$ ^{[1] [2]}

Parameter	Vdd = +3V			Vdd = +5V			Units
	Min.	Typ.	Max.	Min.	Typ.	Max.	
Frequency Range	4.8 - 6.0			4.8 - 6.0			GHz
Gain	12	14.3		13.5	16.5		dB
Gain Variation Over Temperature		0.01			0.01		dB/°C
Noise Figure		1.25	1.5		1.1	1.4	dB
Input Return Loss		13			13		dB
Output Return Loss		13			18		dB
Output Power for 1 dB Compression (P1dB)	12	14		15	18.5		dBm
Saturated Output Power (P _{sat})		15			19.5		dBm
Output Third Order Intercept (IP3)		25.5		27 ^[3]	31.5		dBm
Total Supply Current (I _{dd})		31	40		73	100	mA

[1] R_{bias} resistor sets current, see application circuit herein

[2] V_{dd} = V_{dd1} = V_{dd2}

[3] Guaranteed by Design at 5GHz.

For price, delivery and to place orders: Hittite Microwave Corporation, 2 Elizabeth Drive, Chelmsford, MA 01824

Phone: 978-250-3343 Fax: 978-250-3373 Order On-line at www.hittite.com

Application Support: Phone: 978-250-3343 or apps@hittite.com



HMC717LP3 / 717LP3E

GaAs PHEMT MMIC LOW NOISE AMPLIFIER, 4.8 - 6.0 GHz

Broadband Gain & Return Loss [1][2]

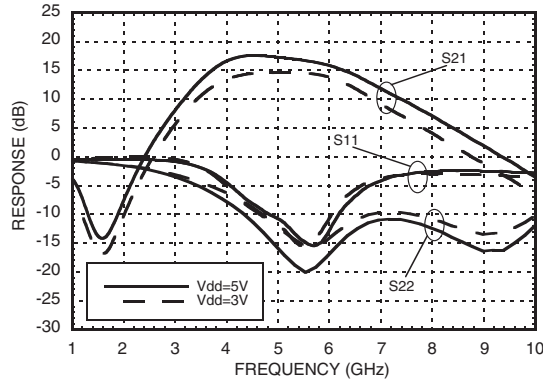

Gain vs. Temperature [1]

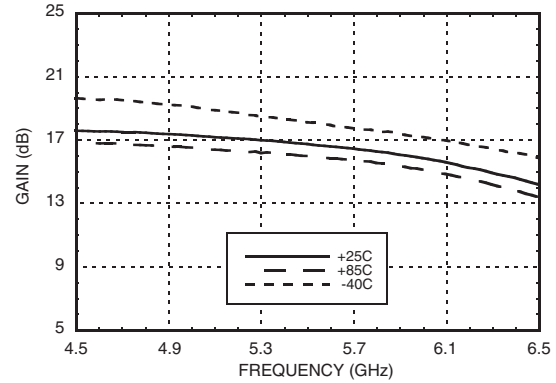

Gain vs. Temperature [2]

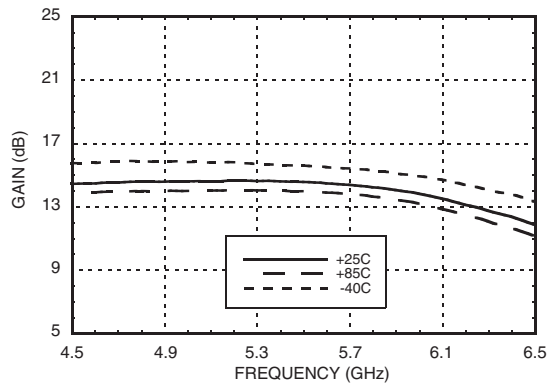

Input Return Loss vs. Temperature [1]

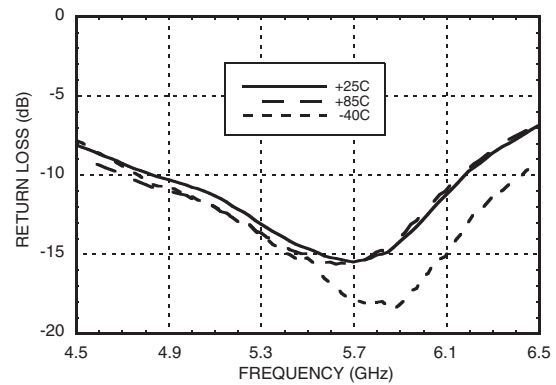

Output Return Loss vs. Temperature [1]

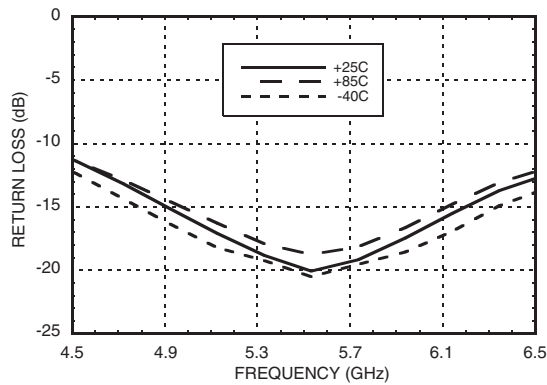

Reverse Isolation vs. Temperature [1]

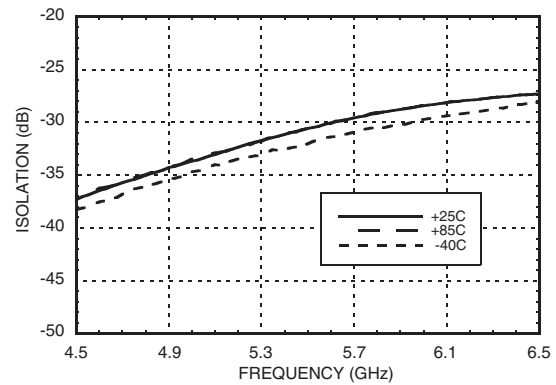

[1] Vdd = 5V, Rbias = 2kΩ [2] Vdd = 3V, Rbias = 20kΩ

Noise Figure vs. Temperature [1] [2] [4]

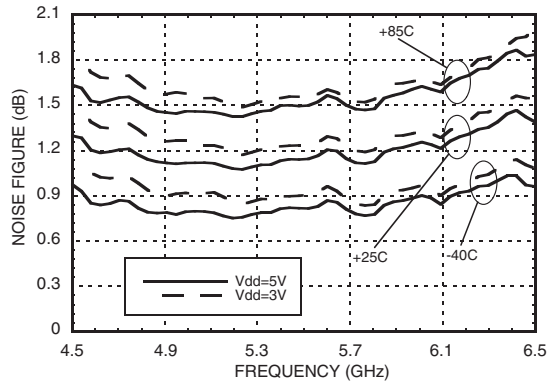

P1dB vs. Temperature [1] [2]

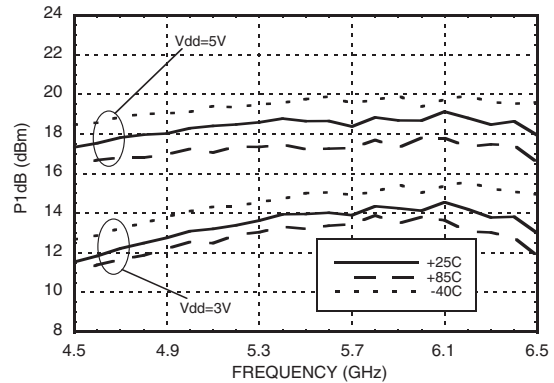

Psat vs. Temperature [1] [2]

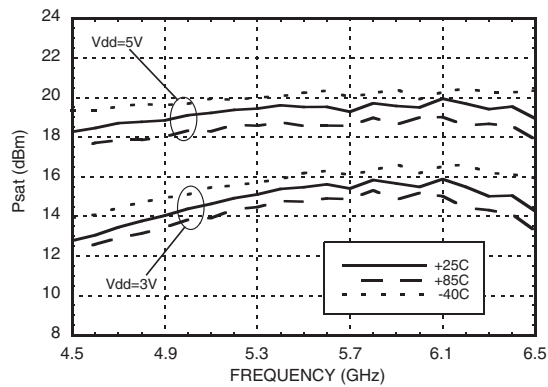

Output IP3 vs. Temperature [1] [2]

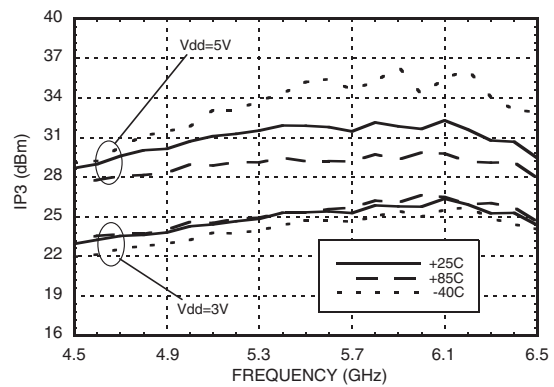

Output IP3 and Total Supply Current vs. Supply Voltage @ 4800 MHz [3]

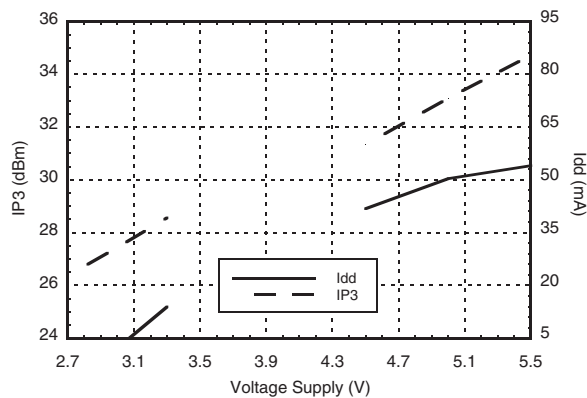

Output IP3 and Total Supply Current vs. Supply Voltage @ 5900 MHz [3]

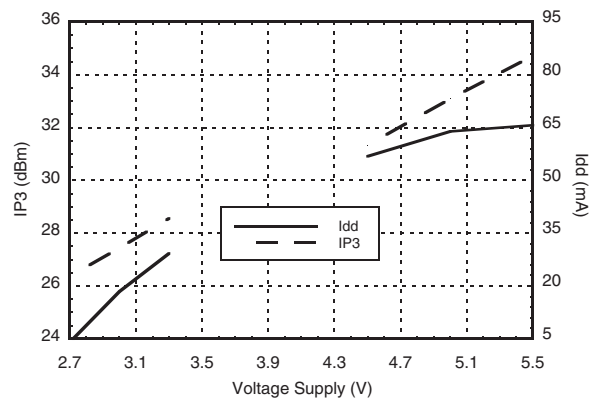

[1] Vdd = 5V, Rbias = 2kΩ [2] Vdd = 3V, Rbias = 20kΩ

[3] Rbias = 2kΩ for Vdd = 5V, Rbias = 20kΩ for Vdd = 3V

[4] Measurement reference plane shown on evaluation PCB drawing.



HMC717LP3 / 717LP3E

GaAs PHEMT MMIC LOW NOISE AMPLIFIER, 4.8 - 6.0 GHz

Power Compression @ 4800 MHz [1]

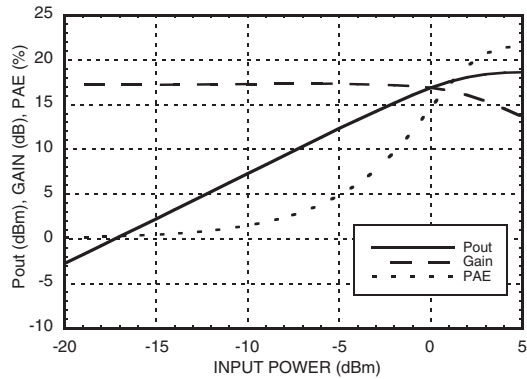

Power Compression @ 4800 MHz [2]

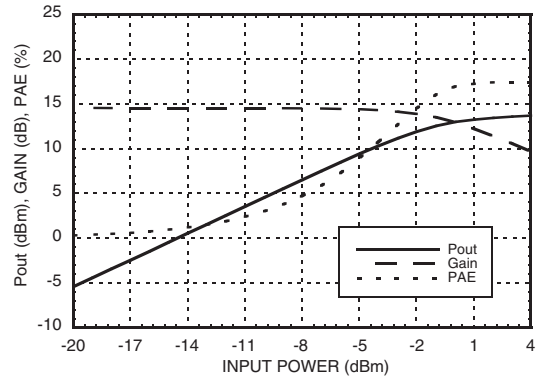

Power Compression @ 5900 MHz [1]

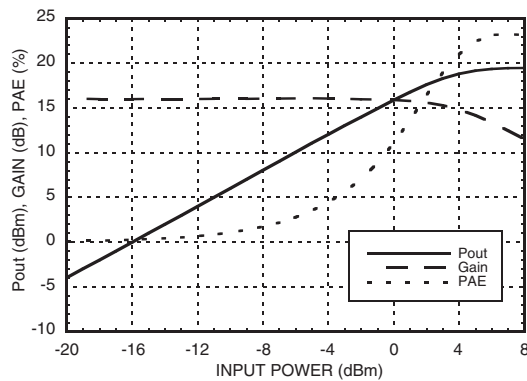

Power Compression @ 5900 MHz [2]

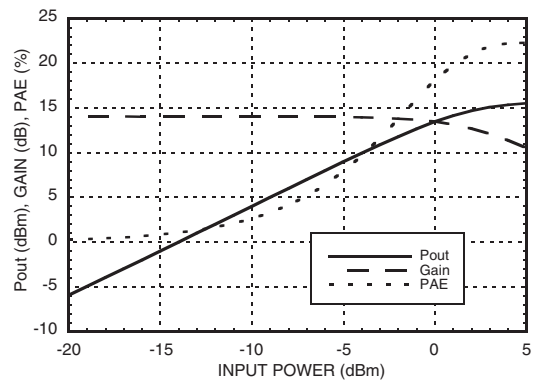

Gain, Power & Noise Figure vs. Supply Voltage @ 4800 MHz [3]

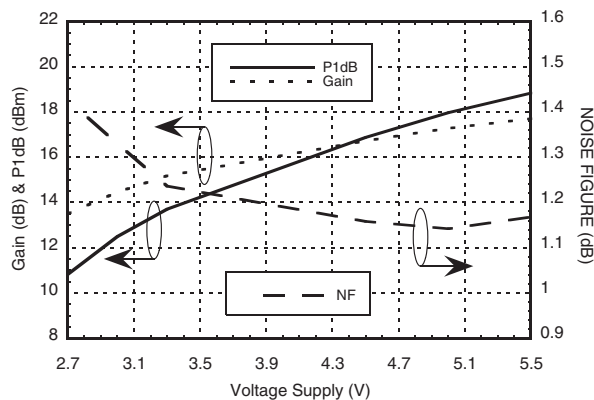

Gain, Power & Noise Figure vs. Supply Voltage @ 5900 MHz [3]

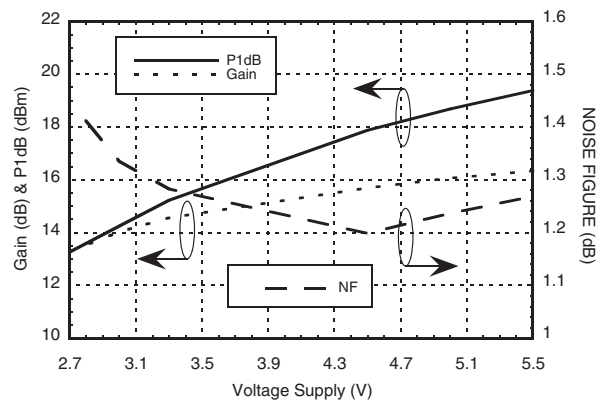

[1] Vdd = 5V, Rbias = 2kΩ [2] Vdd = 3V, Rbias = 20kΩ [3] Rbias = 2kΩ for Vdd = 5V, Rbias = 20kΩ for Vdd = 3V



HMC717LP3 / 717LP3E

GaAs PHEMT MMIC LOW NOISE AMPLIFIER, 4.8 - 6.0 GHz

AMPLIFIERS - LOW NOISE - SMT

Output IP3 vs. Rbias @ 4800 MHz

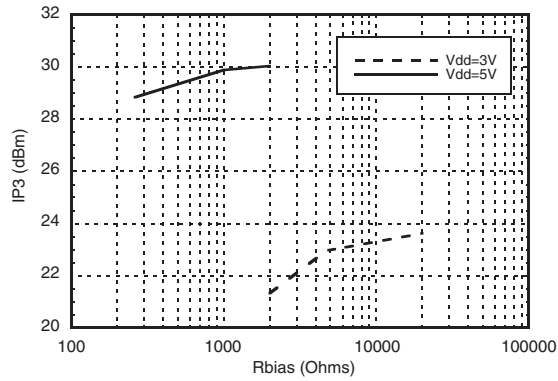

Gain, Noise Figure & Rbias @ 4800 MHz

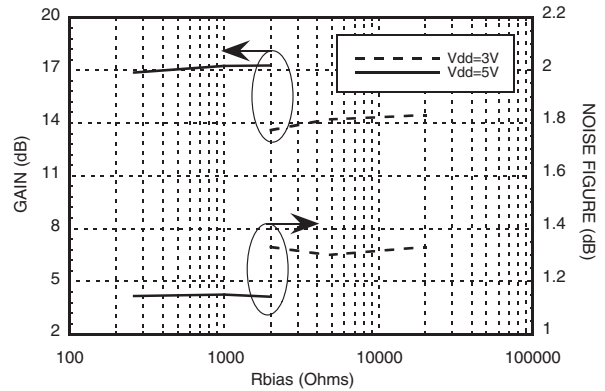

Output IP3 vs. Rbias @ 5900 MHz

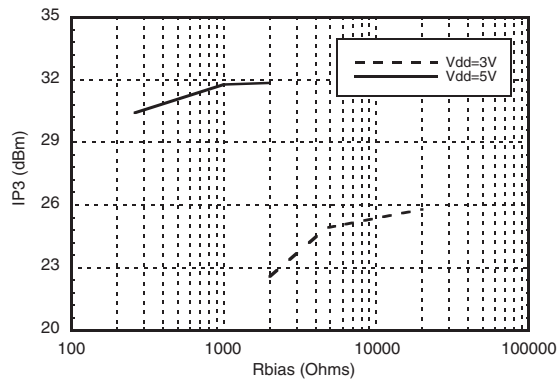

Gain, Noise Figure & Rbias @ 5900 MHz

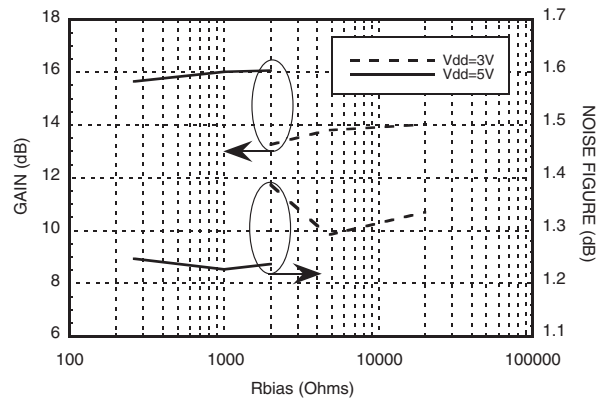

**Absolute Bias Resistor
Range & Recommended Bias Resistor Values**

Vdd (V)	Rbias (Ohms)			Idd (mA)
	Min	Max	Recommended	
3V	2k ^[1]	Open Circuit	2k	20
			4.7k	26
			20k	31
5V	150 ^[2]	Open Circuit	261	50
			1k	65
			2k	73

[1] With Vdd= 3V and Rbias < 2kΩ may result in the part becoming conditionally stable which is not recommended.

[2] With Vdd = 5V and Rbias<150Ω may result in the part becoming conditionally stable which is not recommended.

Absolute Maximum Ratings

Drain Bias Voltage (Vdd)	+5.5V
RF Input Power (RFIN) (Vdd = +5 Vdc)	+10 dBm
Channel Temperature	150 °C
Continuous Pdiss (T= 85 °C) (derate 7.73 mW/°C above 85 °C)	0.5 W
Thermal Resistance (channel to ground paddle)	129.5 °C/W
Storage Temperature	-65 to +150 °C
Operating Temperature	-40 to +85 °C
ESD Sensitivity (HBM)	Class 1A



**ELECTROSTATIC SENSITIVE DEVICE
OBSERVE HANDLING PRECAUTIONS**

Typical Supply Current vs. Supply Voltage

(Rbias = 2kΩ for Vdd = 5V, Rbias = 20kΩ for Vdd = 3V)

Vdd (V)	Idd (mA)
2.7	23
3.0	31
3.3	39
4.5	60
5.0	73
5.5	85

Note: Amplifier will operate over full voltage ranges shown above.

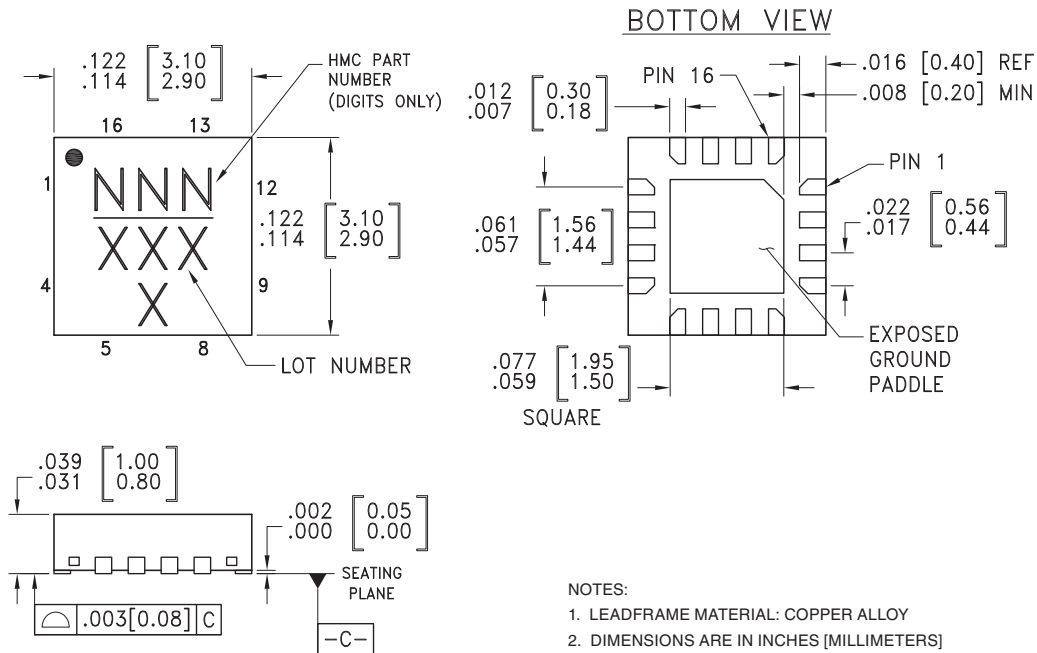
Outline Drawing

NOTES:

1. LEADFRAME MATERIAL: COPPER ALLOY
2. DIMENSIONS ARE IN INCHES [MILLIMETERS]
3. LEAD SPACING TOLERANCE IS NON-CUMULATIVE
4. PAD BURR LENGTH SHALL BE 0.15mm MAXIMUM. PAD BURR HEIGHT SHALL BE 0.05mm MAXIMUM.
5. PACKAGE WARP SHALL NOT EXCEED 0.05mm.
6. ALL GROUND LEADS AND GROUND PADDLE MUST BE SOLDERED TO PCB RF GROUND.
7. REFER TO HITTITE APPLICATION NOTE FOR SUGGESTED LAND PATTERN.

Package Information



Part Number	Package Body Material	Lead Finish	MSL Rating	Package Marking ^[3]
HMC717LP3	Low Stress Injection Molded Plastic	Sn/Pb Solder	MSL1 ^[1]	717 XXXX
HMC717LP3E	RoHS-compliant Low Stress Injection Molded Plastic	100% matte Sn	MSL1 ^[2]	717 XXXX

[1] Max peak reflow temperature of 235 °C

[2] Max peak reflow temperature of 260 °C

[3] 4-Digit lot number XXXX

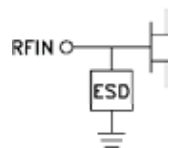
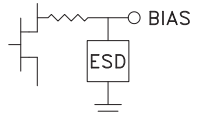
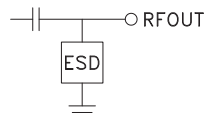
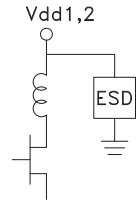
Pin Descriptions

Pin Number	Function	Description	Interface Schematic
1, 3 - 7, 9, 10, 12, 14, 16	N/C	No connection required. These pins may be connected to RF/DC ground without affecting performance.	
2	RFIN	This pin is DC coupled See the application circuit for off-chip component.	
8	BIAS	This pin is used to set the DC current of the amplifier by selection of the external bias resistor. See application circuit.	
11	RFOUT	This pin is AC coupled and matched to 50 Ohms	
13, 15	Vdd2, Vdd1	Power supply voltage. Bypass capacitors are required. See application circuit.	
	GND	Package bottom must be connected to RF/DC ground	



MICROWAVE CORPORATION v03.1112



HMC717LP3 / 717LP3E

GaAs PHEMT MMIC LOW NOISE AMPLIFIER, 4.8 - 6.0 GHz

Application Circuit

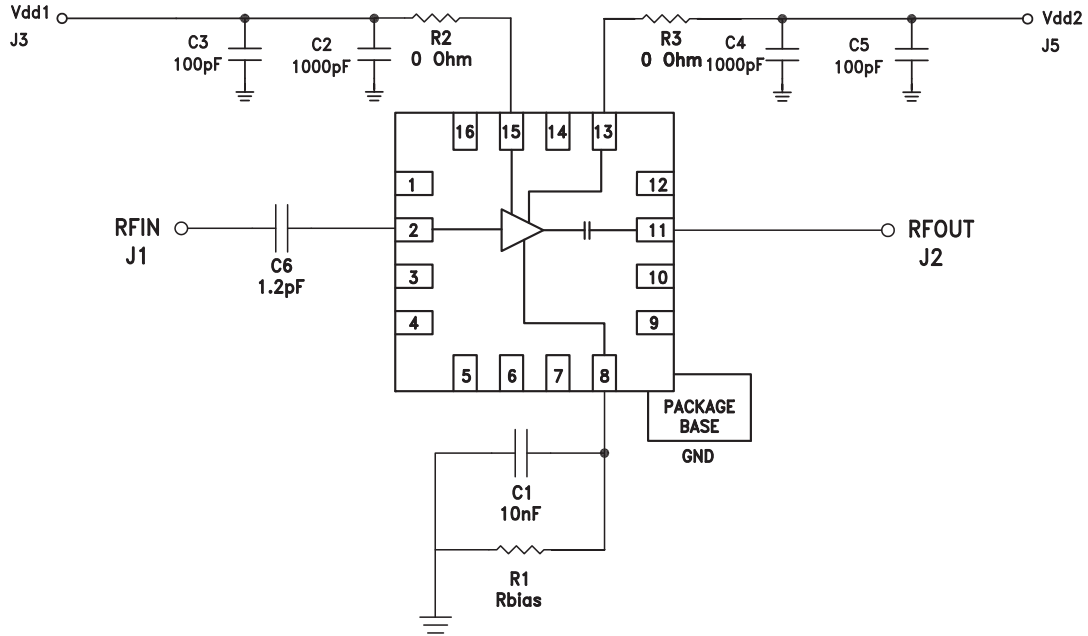

AMPLIFIERS - LOW NOISE - SMT

For price, delivery and to place orders: Hittite Microwave Corporation, 2 Elizabeth Drive, Chelmsford, MA 01824

Phone: 978-250-3343 Fax: 978-250-3373 Order On-line at www.hittite.com

Application Support: Phone: 978-250-3343 or apps@hittite.com

www.BDTIC.com/Hittite/

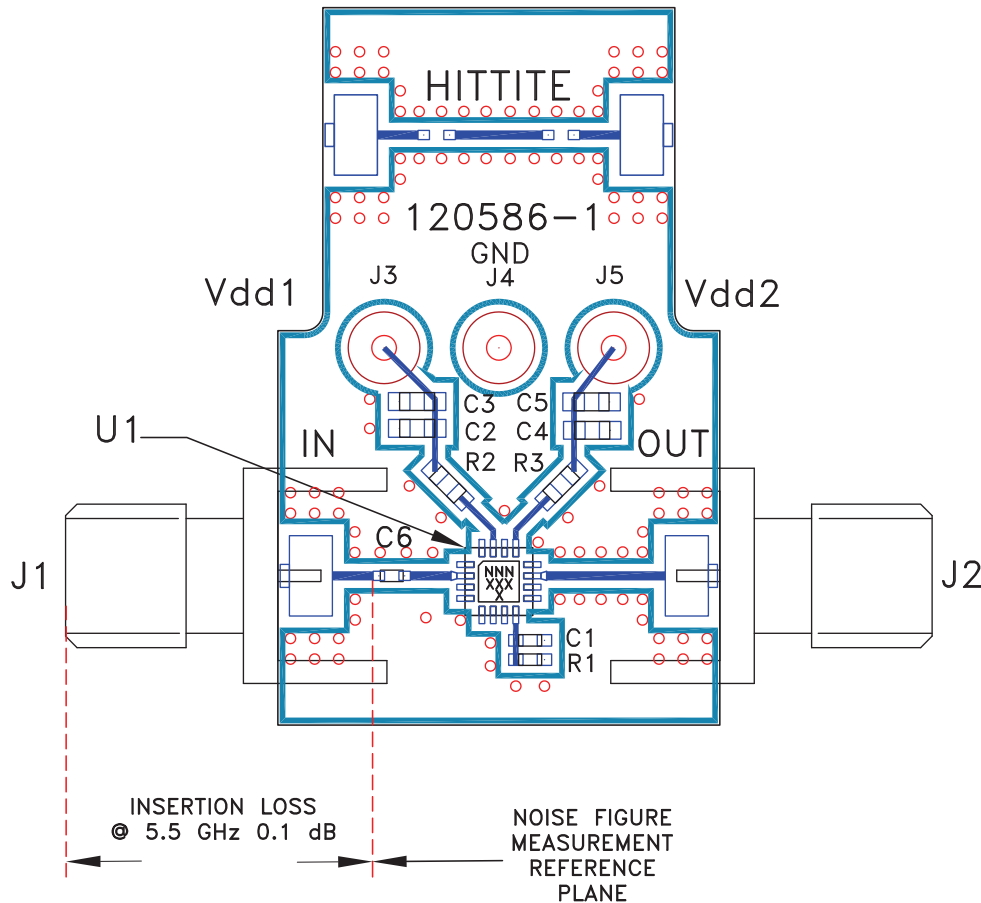
Evaluation PCB

List of Materials for Evaluation PCB 122416 [1]

Item	Description
J1, J2	PCB Mount SMA Connector
J3 - J5	DC Pins
C1	10 nF Capacitor, 0402 Pkg.
C2, C4	1000 pF Capacitor, 0603 Pkg.
C3, C5	100 pF Capacitor, 0603 Pkg.
C6	1.2 pF Capacitor, 0402 Pkg.
R1	2k Ohm Resistor, 0402 Pkg. (Rbias)
R2, R3	0 Ohm Resistor, 0402 Pkg.
U1	HMC717LP3(E) Amplifier
PCB [2]	120586 Evaluation PCB

[1] Reference this number when ordering complete evaluation PCB

[2] Circuit Board Material: Rogers 4350.

The circuit board used in this application should use RF circuit design techniques. Signal lines should have 50 Ohm impedance while the package ground leads and exposed paddle should be connected directly to the ground plane similar to that shown. A sufficient number of via holes should be used to connect the top and bottom ground planes. The evaluation board should be mounted to an appropriate heat sink. The evaluation circuit board shown is available from Hittite upon request.