



GaAs pHEMT MMIC 2 Watt POWER AMPLIFIER SMT WITH POWER DETECTOR , 9 - 14 GHz

Typical Applications

The HMC952LP5GE is ideal for:

- Point-to-Point Radios
- Point-to-Multi-Point Radios
- SATCOM
- Military & Space

Features

- High P1dB Output Power: +34 dBm
- High Psat Output Power: +35 dBm
- High Gain: 33 dB
- High Output IP3: +43 dBm
- Supply Voltage: Vdd = +6V @ 1400 mA
- 50 Ohm Matched Input/Output
- No external matching required

Functional Diagram

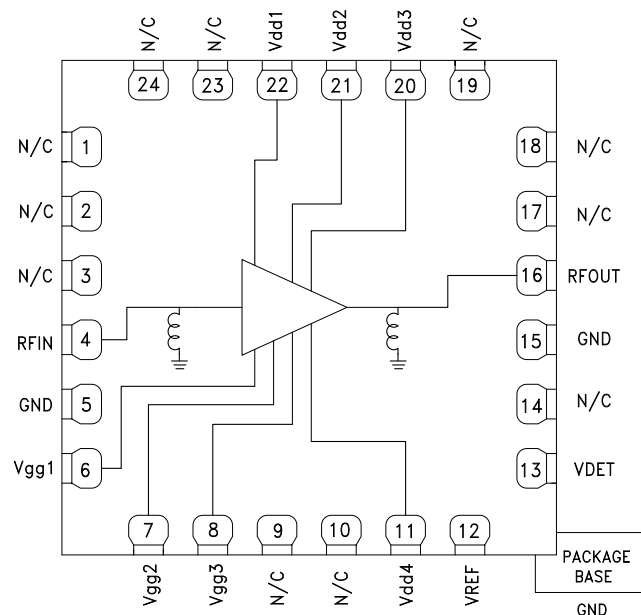

General Description

The HMC952LP5GE is a four stage GaAs PHEMT MMIC Medium Power Amplifier with a temperature compensated on chip power detector which operates between 9 and 14 GHz. The amplifier provides 33 dB of gain, +35 dBm of saturated output power, and 27% PAE from a +6V supply. With up to +43 dBm IP3 the HMC952LP5GE is ideal for high linearity applications in military and space as well as point-to-point and point-to-multi-point radios. The HMC952LP5GE amplifier I/Os are internally matched.

Electrical Specifications, $T_A = +25^\circ C$, Vdd1, Vdd2, Vdd3, Vdd4 = +6V, Idd = 1400 mA [1]

Parameter	Min.	Typ.	Max.	Min.	Typ.	Max.	Units
Frequency Range		9 - 10		10 - 14			GHz
Gain [2]	30	33		30	33		dB
Gain Variation Over Temperature		0.05		0.05			dB/ °C
Input Return Loss		12		15			dB
Output Return Loss		9		12			dB
Output Power for 1 dB Compression (P1dB) [2]	30.5	33		31.5	34		dBm
Saturated Output Power (Psat) [2]		34.5		35			dBm
Output Third Order Intercept (IP3) [2] [3]		42		43			dBm
Total Supply Current		1400		1400			mA

[1] Adjust Vgg between -2 to 0V to achieve Idd = 1400 mA typical.

[2] Board loss subtracted out.

[3] Measurement taken at Pout / tone = +20 dBm.



GaAs pHEMPT MMIC 2 Watt POWER AMPLIFIER SMT WITH POWER DETECTOR, 9 - 14 GHz

Gain & Return Loss

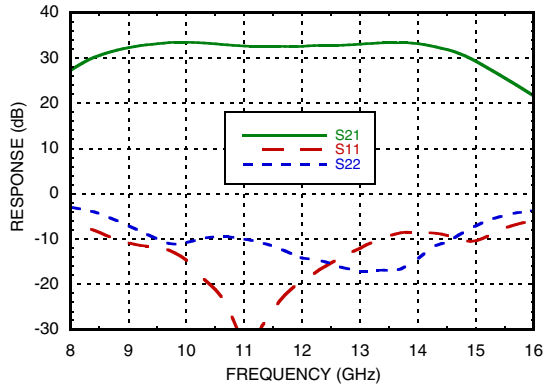

Gain vs. Temperature

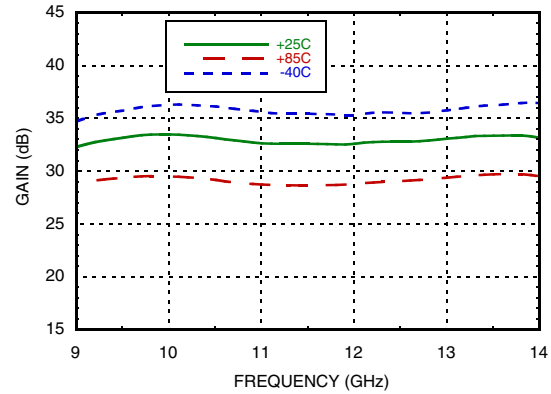

Input Return Loss vs. Temperature

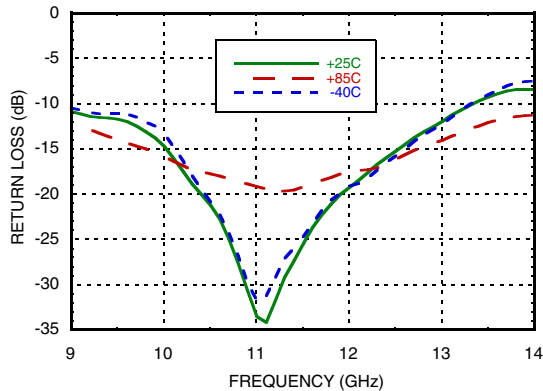

Output Return Loss vs. Temperature

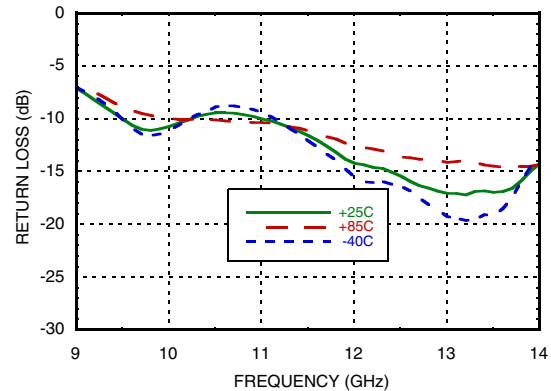

P1dB vs. Temperature

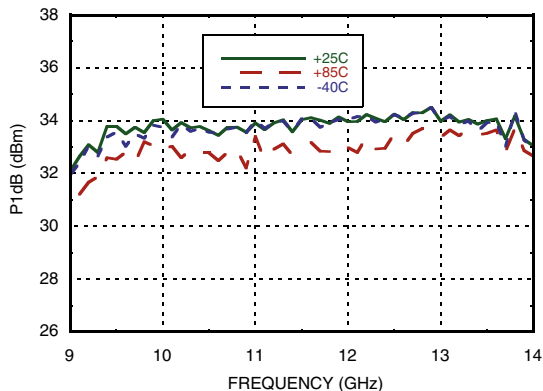

P1dB vs. Supply Voltage

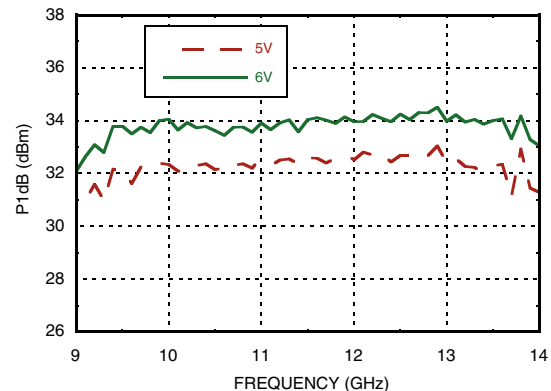



GaAs pHEMPT MMIC 2 Watt POWER AMPLIFIER SMT WITH POWER DETECTOR, 9 - 14 GHz

AMPLIFIERS - LINEAR & POWER - SMT

Psat vs. Temperature

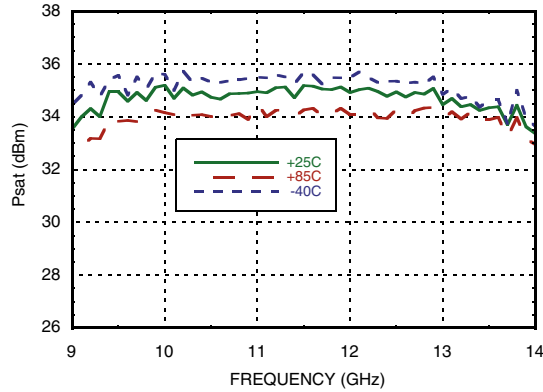

Psat vs. Supply Voltage

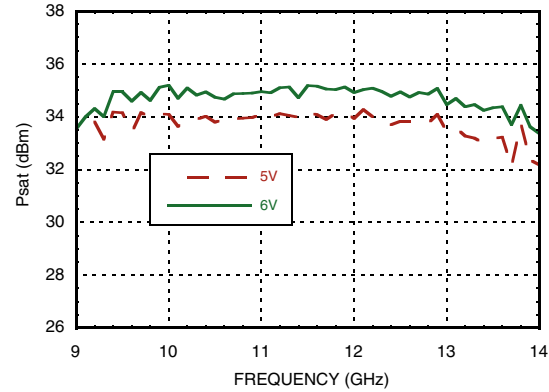

P1dB vs. Supply Current

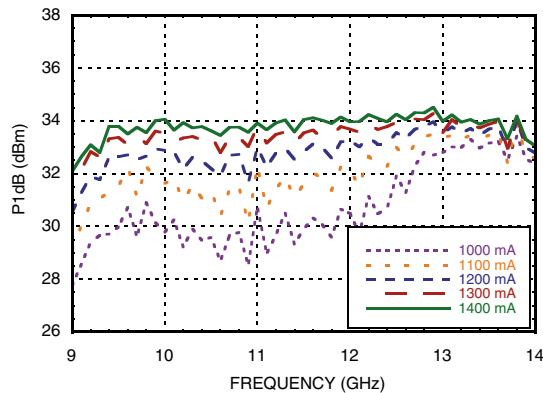

Psat vs. Supply Current

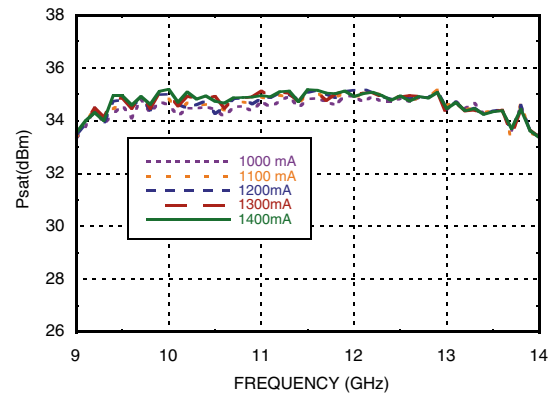

Output IP3 vs. Temperature, Pout/tone = +20 dBm

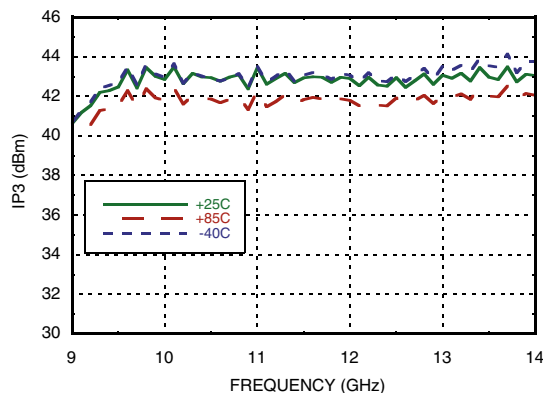

Output IP3 vs. Supply Current, Pout/tone = +20 dBm

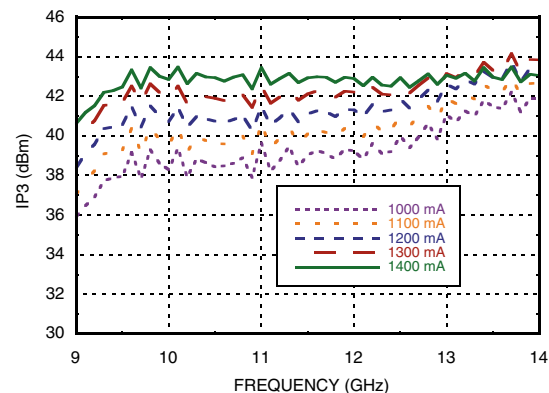



GaAs pHEMPT MMIC 2 Watt POWER AMPLIFIER SMT WITH POWER DETECTOR, 9 - 14 GHz

Output IP3 vs. Supply Voltage, Pout/tone = +20 dBm

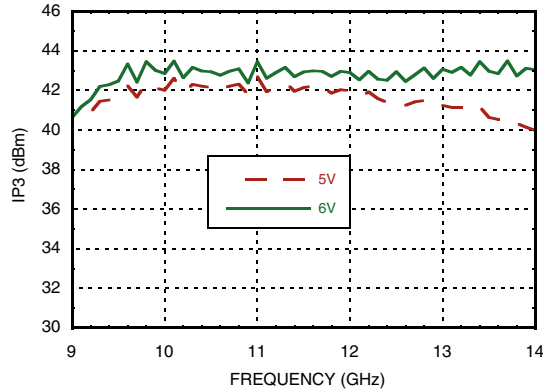

Output IM3 @ Vdd = +5V

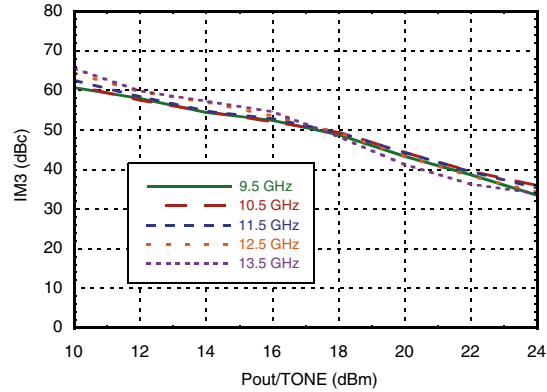

Output IM3 @ Vdd = +6V

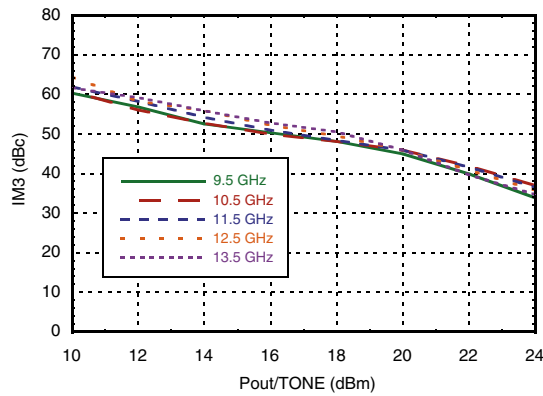

Noise Figure vs. Temperature

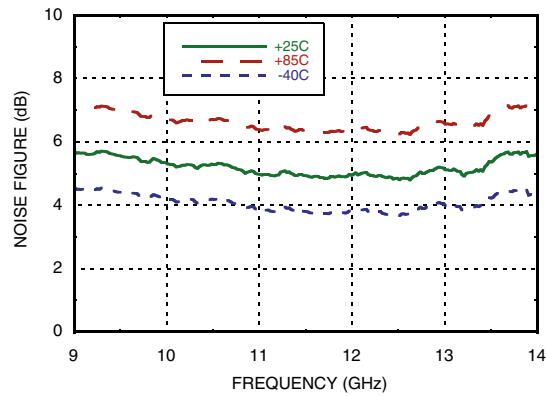

Power Compression @ 9.5 GHz

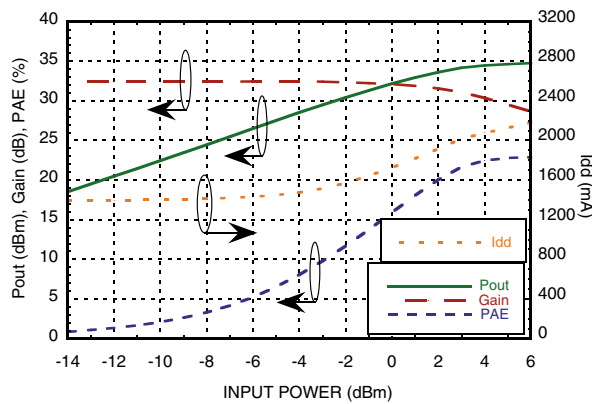

Power Compression @ 11.5 GHz

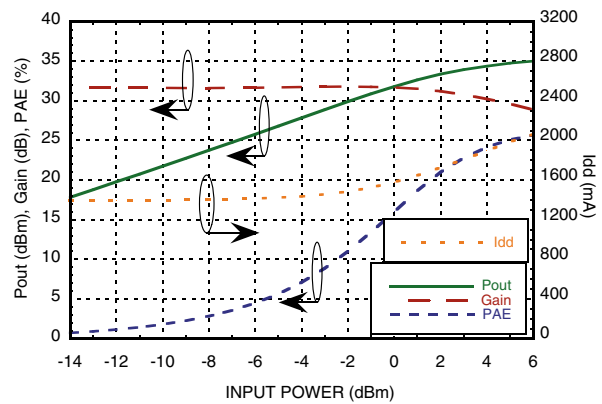



GaAs pHEMPT MMIC 2 Watt POWER AMPLIFIER SMT WITH POWER DETECTOR, 9 - 14 GHz

AMPLIFIERS - LINEAR & POWER - SMT

Power Compression @ 13.5 GHz

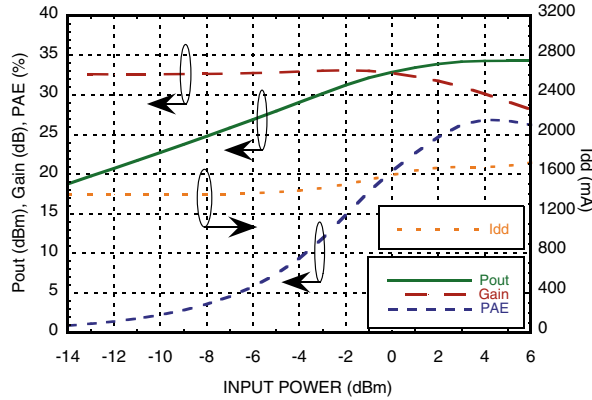

Detector Voltage vs. Frequency & Temperature

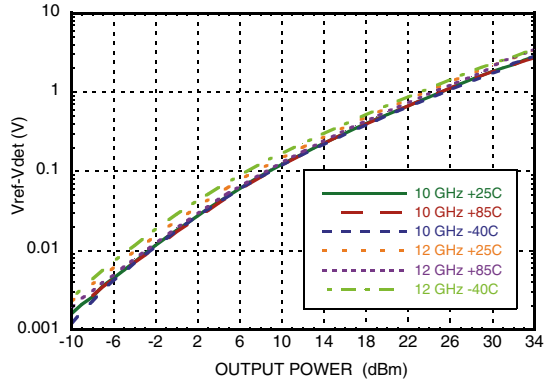

Reverse Isolation vs. Temperature

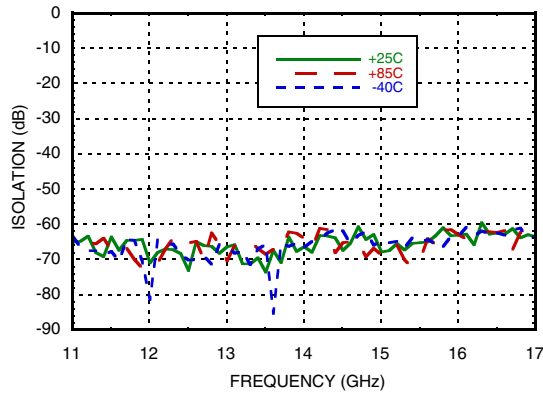

Gain & Power vs. Supply Current @ 11.5 GHz

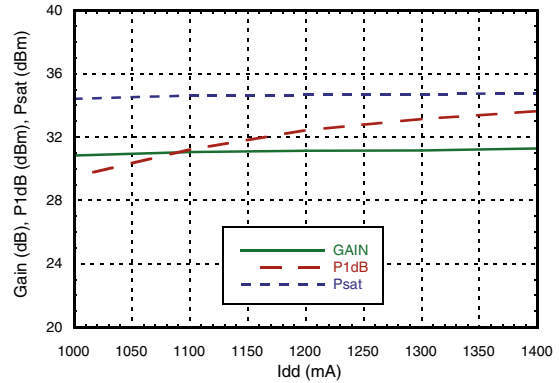

Gain & Power vs. Supply Voltage @ 11.5 GHz

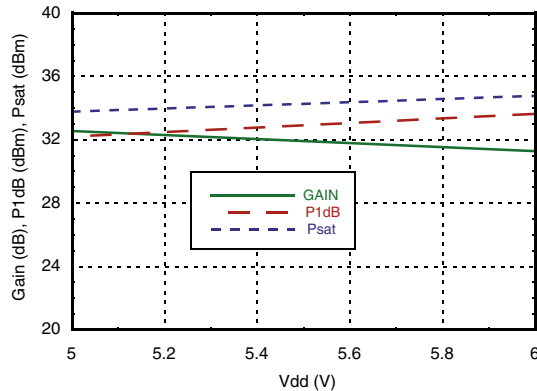

Power Dissipation

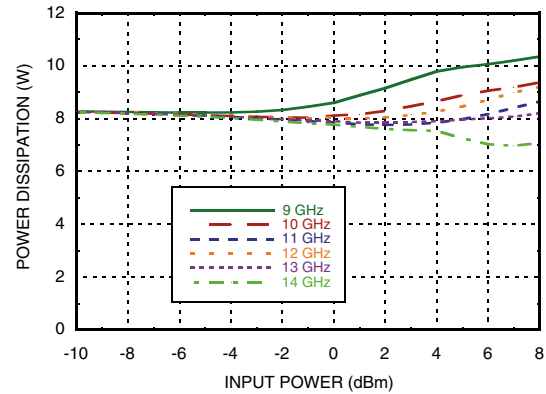

GaAs pHEMPT MMIC 2 Watt POWER AMPLIFIER SMT WITH POWER DETECTOR, 9 - 14 GHz

Absolute Maximum Ratings

Drain Bias Voltage (Vdd)	+8 Vdc
Gate Bias Voltage (Vgg)	-3 - 0 Vdc
RF Input Power (RFIN)	+24 dBm
Channel Temperature	150 °C
Continuous Pdiss (T= 85 °C) (derate 137 mW/°C above 85 °C)	8.9 W
Thermal Resistance (channel to die bottom)	7.3 °C/W
Storage Temperature	-65 to 150°C
Operating Temperature	-55 to 85 °C
ESD Sensitivity (HBM)	Class 0, Passed 150V

Typical Supply Current vs. Vdd

Vdd (V)	Idd (mA)
+5	1400
+6	1400

Adjust Vgg1 to achieve Idd = 1400 mA



**ELECTROSTATIC SENSITIVE DEVICE
OBSERVE HANDLING PRECAUTIONS**

Outline Drawing

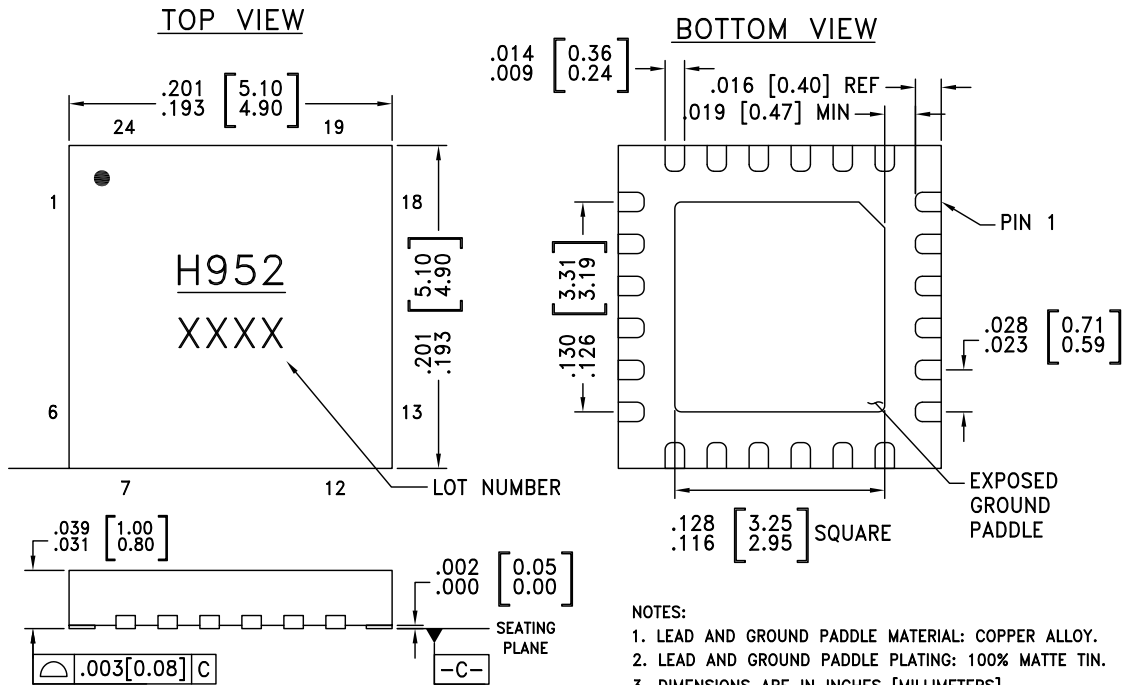

NOTES:

1. LEAD AND GROUND PADDLE MATERIAL: COPPER ALLOY.
2. LEAD AND GROUND PADDLE PLATING: 100% MATTE TIN.
3. DIMENSIONS ARE IN INCHES [MILLIMETERS].
4. LEAD SPACING TOLERANCE IS NON-CUMULATIVE.
5. PAD BURR LENGTH SHALL BE 0.15mm MAX. PAD BURR HEIGHT SHALL BE 0.25mm MAX.
6. PACKAGE WARP SHALL NOT EXCEED 0.05mm
7. ALL GROUND LEADS AND GROUND PADDLE MUST BE SOLDERED TO PCB RF GROUND.

Package Information

Part Number	Package Body Material	Lead Finish	MSL Rating [2]	Package Marking [1]
HMC952LP5GE	RoHS-compliant Low Stress Injection Molded Plastic	100% matte Sn	MSL1	H952 XXXX

[1] 4-Digit lot number XXXX

[2] Max peak reflow temperature of 260 °C

For price, delivery and to place orders: Hittite Microwave Corporation, 2 Elizabeth Drive, Chelmsford, MA 01824

Phone: 978-250-3343 Fax: 978-250-3373 Order On-line at www.hittite.com



Application Support: Phone: 978-250-3343 or apps@hittite.com

www.BDTIC.com/Hittite/

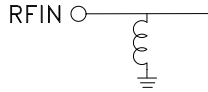

GaAs pHEMPT MMIC 2 Watt POWER AMPLIFIER SMT WITH POWER DETECTOR, 9 - 14 GHz

Pin Descriptions

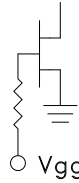
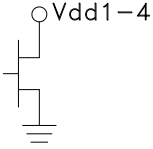
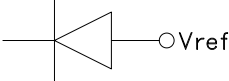
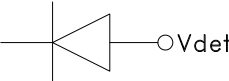
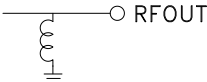
Pin Number	Function	Description	Interface Schematic
1-3, 9, 10, 14, 17-19, 23, 24	N/C	These pins are not connected internally, however all data shown herein was measured with these pins connected to RF/DC ground externally.	
4	RFIN	This pin is DC coupled and matched to 50 Ohms.	
5, 15	GND	These pins and package bottom must be connected to RF/DC ground.	
6-8	Vgg1, Vgg2, Vgg3	Gate control for amplifier External bypass capacitors of 100pF, 10nF and 4.7uF are required.	
11, 20-22	Vdd4, Vdd3, Vdd2, Vdd1	Drain bias voltage for amplifier. external bypass capacitors of 100pF, 10nF and 4.7uF are required.	
12	Vref	DC bias of diode biased through external resistor, used for temperature compensation of Vdet. See application circuit.	
13	Vdet	DC voltage representing RF output power rectified by diode which is biased through an external resistor. See application circuit.	
16	RFOUT	This pin is DC coupled and matched to 50 Ohms	



GaAs pHEMPT MMIC 2 Watt POWER AMPLIFIER SMT WITH POWER DETECTOR, 9 - 14 GHz

Application Circuit

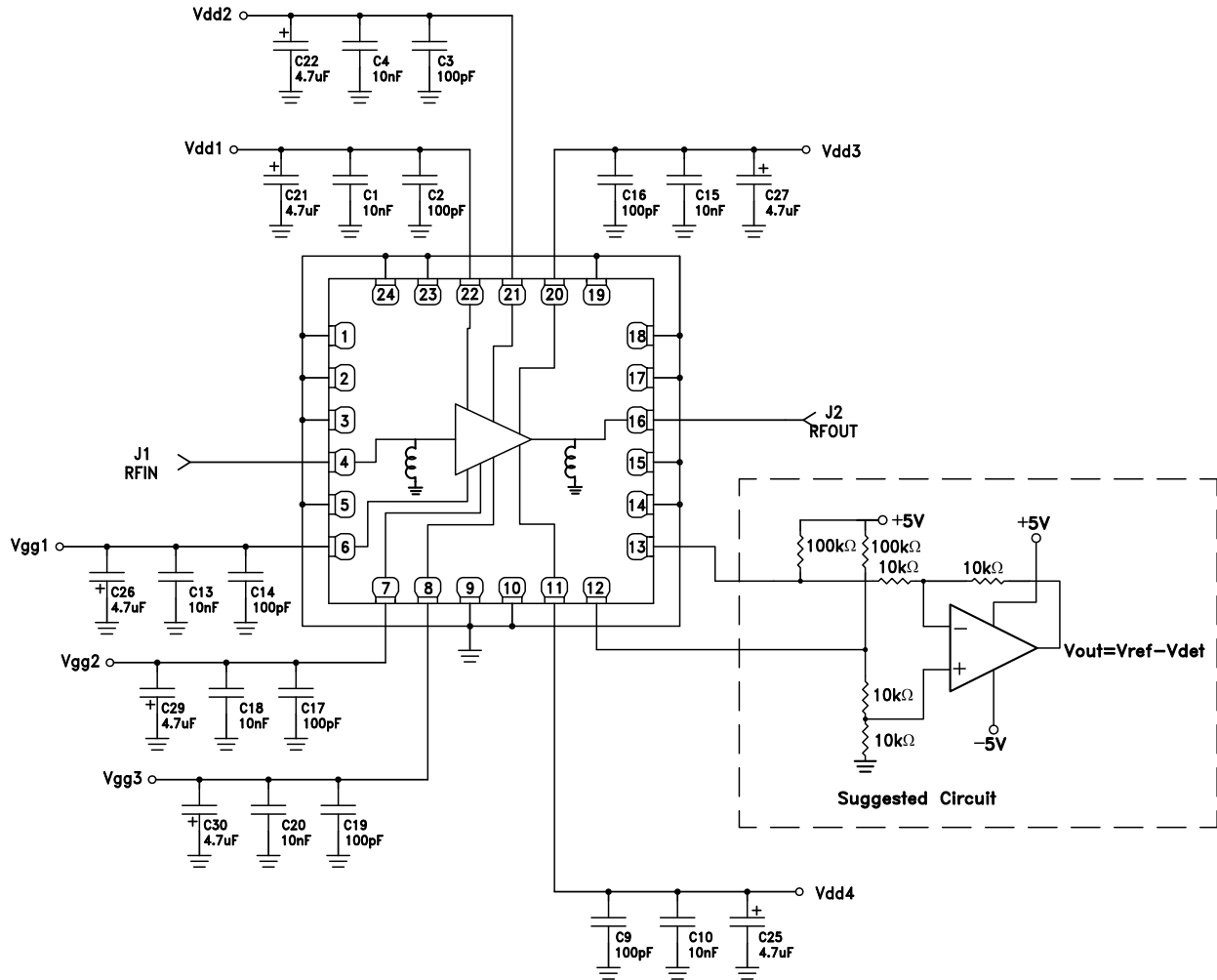



GaAs pHEMPT MMIC 2 Watt POWER AMPLIFIER SMT WITH POWER DETECTOR, 9 - 14 GHz

Evaluation PCB

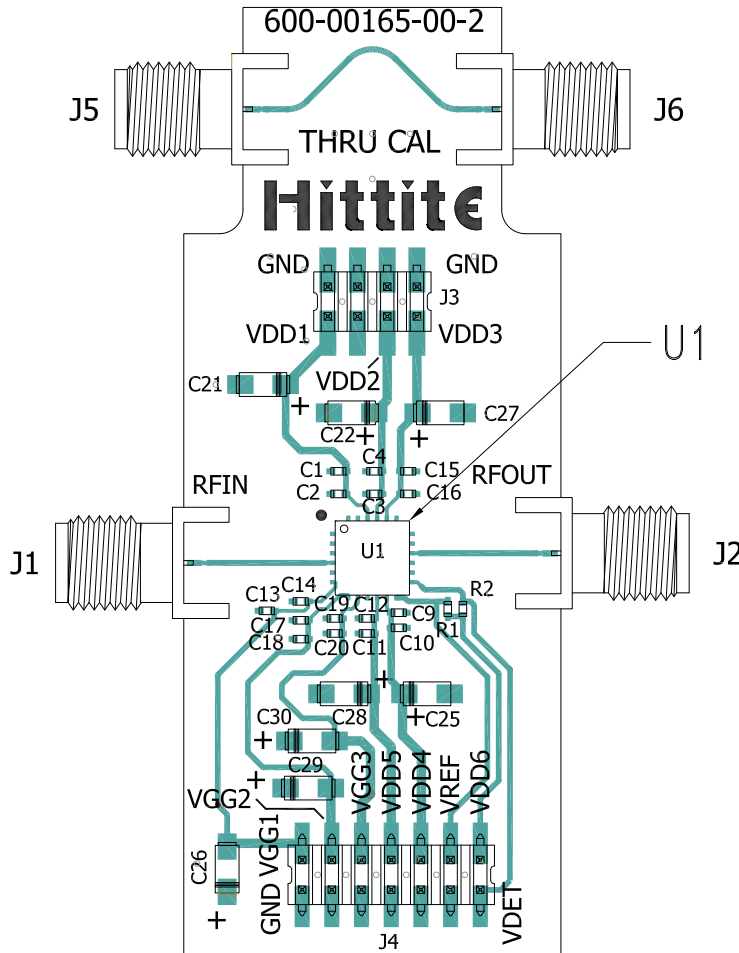

List of Materials for Evaluation PCB EVAL01-HMC952LP5GE [1]

Item	Description
J1, J2, J5, J6	K Connector SRI
J3, J4	DC Pin
C2, C3, C9, C12, C14, C16, C17, C19	100 pF Capacitor, 0402 Pkg.
C1, C4, C10, C11, C13, C15, C18, C20	10 nF Capacitor, 0402 Pkg.
C21, C22, C25 - C30	4.7uF Capacitor, Case A.
U1	HMC952LP5GE Power Amplifier
PCB	600-00163-00 Evaluation PCB

[1] Reference this number when ordering complete evaluation PCB

[2] Circuit Board Material: Rogers 4350 or Arlon FR4

The circuit board used in the application should use RF circuit design techniques. Signal lines should have 50 Ohm impedance while the package ground leads and exposed paddle should be connected directly to the ground plane similar to that shown. A sufficient number of via holes should be used to connect the top and bottom ground planes. The evaluation circuit board shown is available from Hittite upon request.



**GaAs pHEMPT MMIC 2 Watt POWER AMPLIFIER SMT
WITH POWER DETECTOR, 9 - 14 GHz**

Notes: