

ISA-WELD® - Präzisionswiderstände / precision resistors

TECHNISCHE DATEN / TECHNICAL DATA		
Widerstandswerte	Resistance values	2, 3, 5, 10, 20, 25 mOhm*
Toleranz	Tolerance	1 %, 2%, 5 %
Temperaturkoeffizient	Temperature coefficient (tcr)	ab/from 100 ppm/K **
Temperaturbereich	Applicable temperature range	-55 °C bis/to +170 °C
Belastbarkeit	Load capacity	2 W
Innerer Wärmewiderstand (R_{thi})	Internal heat resistance (R_{thi})	ab/from 25 K/W **
Induktivität	Inductance	< 10 nH
Stabilität (Nennlast) Abweichung T_K = Kontaktstellentemperatur Stability (nominal load) deviation T_K = Terminal temperature		< 0.5 % nach/after 2000 h (T_K = 100 °C) < 2.0 % nach/after 2000 h (T_K = 130 °C)

* weitere R-Werte auf Anfrage / more resistance values upon request

** siehe Tabelle Seite 3 / see table on page 3

MERKMALE / FEATURES

- 2 Watt Dauerleistung bei 130 °C
2 Watt permanent power at 130 °C
- Dauerströme bis 32 A (2 mOhm)
Constant current up to 32 A (2 mOhm)
- Kupferanschlüsse
Copper connectors
- Sehr gute Langzeitstabilität
Excellent long term stability
- Ideal geeignet für DCB Keramik / IMS Substrat
Ideal suited for mounting on DBC / IMS substrate
- Geeignet für Löttemperaturen bis 350 °C / 30 sek
oder 250 °C / 10 min
Max. solder temperature up to 350 °C / 30 sec
or 250 °C / 10 min
- Bauteilmontage: Reflow-löten
Mounting: Reflow-soldering
- AEC-Q200 qualifiziert
AEC-Q200 qualification

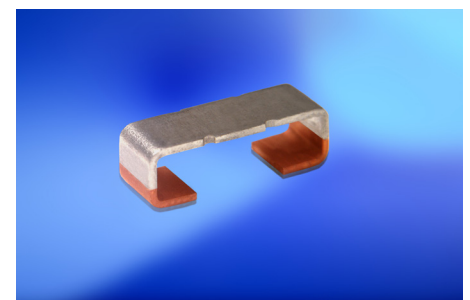

Bauform / Size 3812

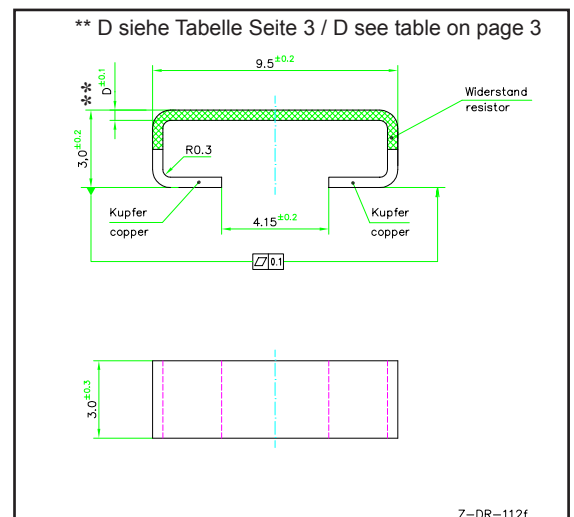

APPLIKATIONEN / APPLICATION

- Messwiderstand für Leistungshybride
Current sensor for power hybrid applications
- Frequenzumrichter
Frequency converters
- Leistungsmodule
Power modules
- Hochstromanwendungen in der Automobiltechnik
High current applications for the automotive market

TK, Lastminderung und Langzeitstabilität / TCR, power derating and long term stability

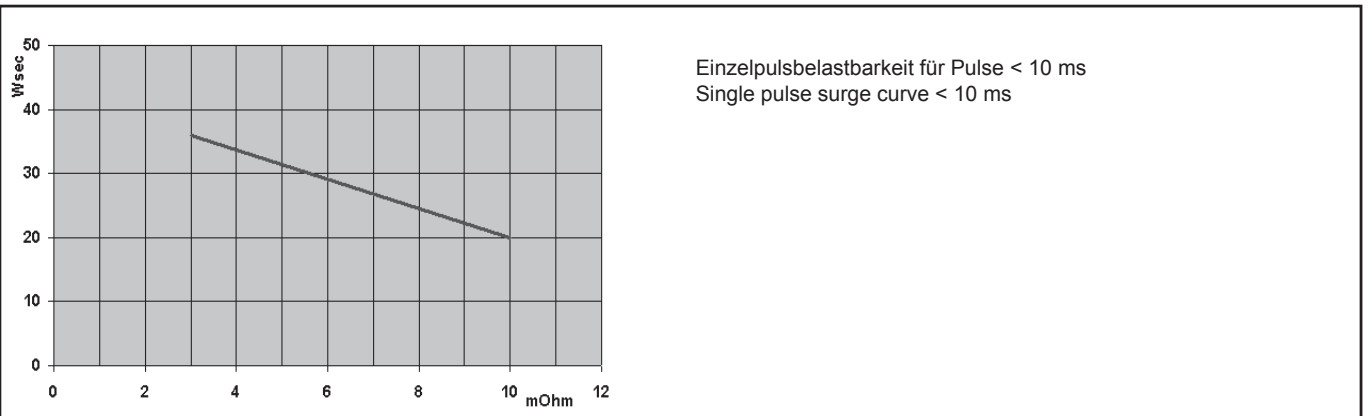
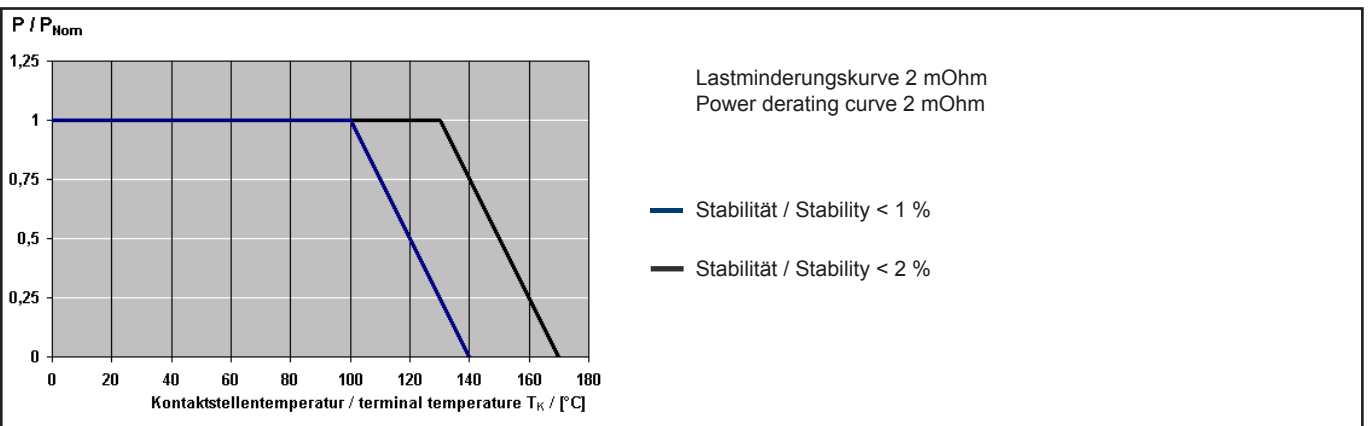
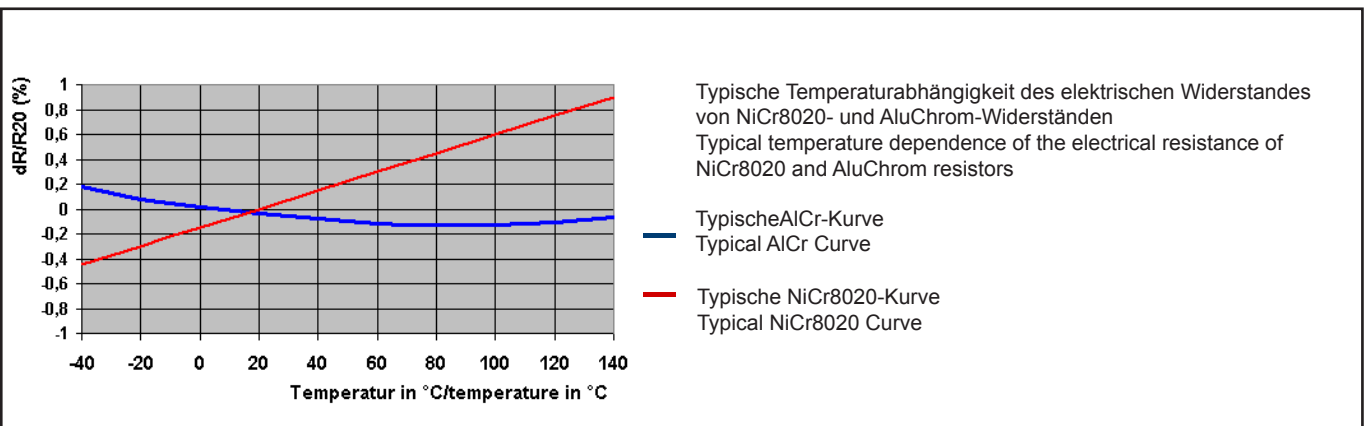
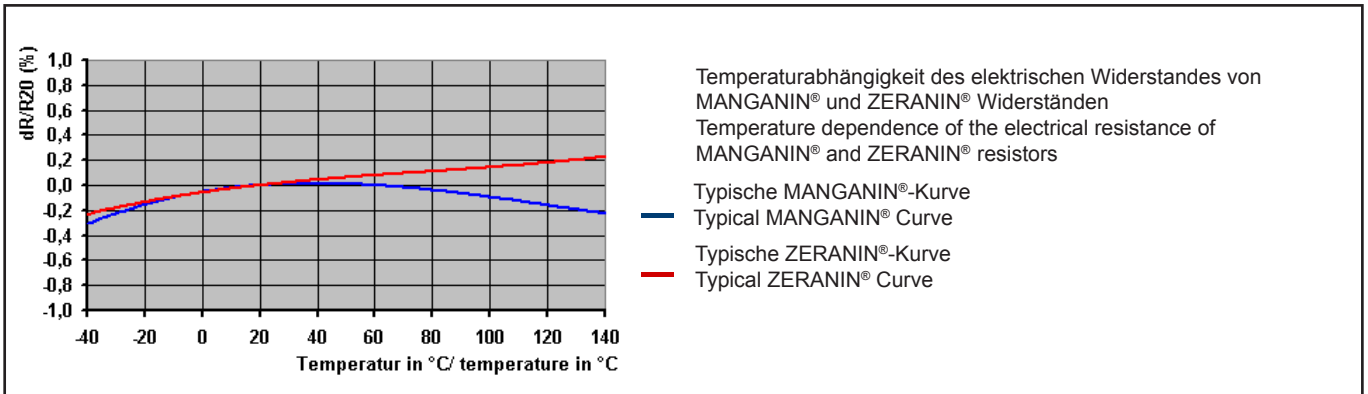

Vorschlag für Leiterplatten Layout (Reflowlöten) Proposal for pcb-layout (Reflow soldering)

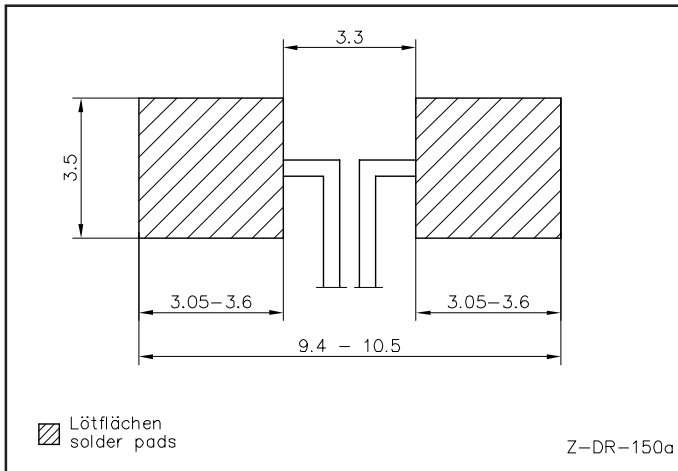

Für 4 W-Variante breiteres Layout auf Anfrage
4 W type broaden layout upon request

Lötprofil Vorschlag / Recommended solder profile			
Reflow-, IR-löten / Reflow-, infrared-soldering			
Temperature	260 °C	255 °C	217 °C
Zeit/time (s)	peak	40	90
RoHS 2002/95/EG konform seit Produktstart. Ausführliche Informationen erhalten Sie auf unserer Homepage: www.isabellenhuette.de RoHS 2002/95/EC compliance since product launch. For more information please visit our website: www.isabellenhuette.de			

GURTINFORMATIONEN / TAPE & REEL INFORMATION	
Norm / Specification	DIN EN 60286-3
Gurtbreite / Tape width	16 mm
Anzahl Bauteile / Parts per reel	2500 Stk. / pcs.

BESTELLBEZEICHNUNG / ORDERING CODE			
BRS-N-R010-2.0			
Typ	Material	Widerstandswert	Toleranz
Type	Material	Resistance value	Tolerance
BRS	NiCr8020	10 mOhm	2 %

Typ	Wert / mΩ	Dicke / mm	R _{thi} / K/W	TK / ppm/K	P / W
Type	Value / mΩ	Thickness / mm	R _{thi} / K/W	TC / ppm/K	P / W
BRS-Z-R002	2	0.50	25	130	2
BRS-M-R003	3	0.50	35	100	2
BRS-M-R005	5	0.30	55	100	2
BRS-N-R010	10	0.40	70	100	2
BRS-A-R020	20	0.30			2
BRS-A-R025	25	0.24			2

Abkürzung Typ / Abbreviation type A=Aluchrom, M=MANGANIN®, N= Ni-Cr 8020, Z=ZERANIN®30

Gewährleistung

Alle Angaben über Eignung, Verarbeitung und Anwendung unserer Produkte, technische Beratung und sonstige Angaben erfolgen nach bestem Wissen, befreien den Käufer jedoch nicht von eigenen Prüfungen und Versuchen.

Warranty

All information regarding the suitability, workability and applicability of our products, all technical advice and other information are provided to the best of our knowledge and belief, but shall not discharge the buyer from his own examinations and tests.



Grenzkurve für maximale Pulsenergie bzw. Pulsleistung für Dauerbetrieb
Maximum pulse energy respectively pulse power for continuous operation. Mittlere
Belastung maximal P_{Nenn} / Max. average Power P_{Nominal}

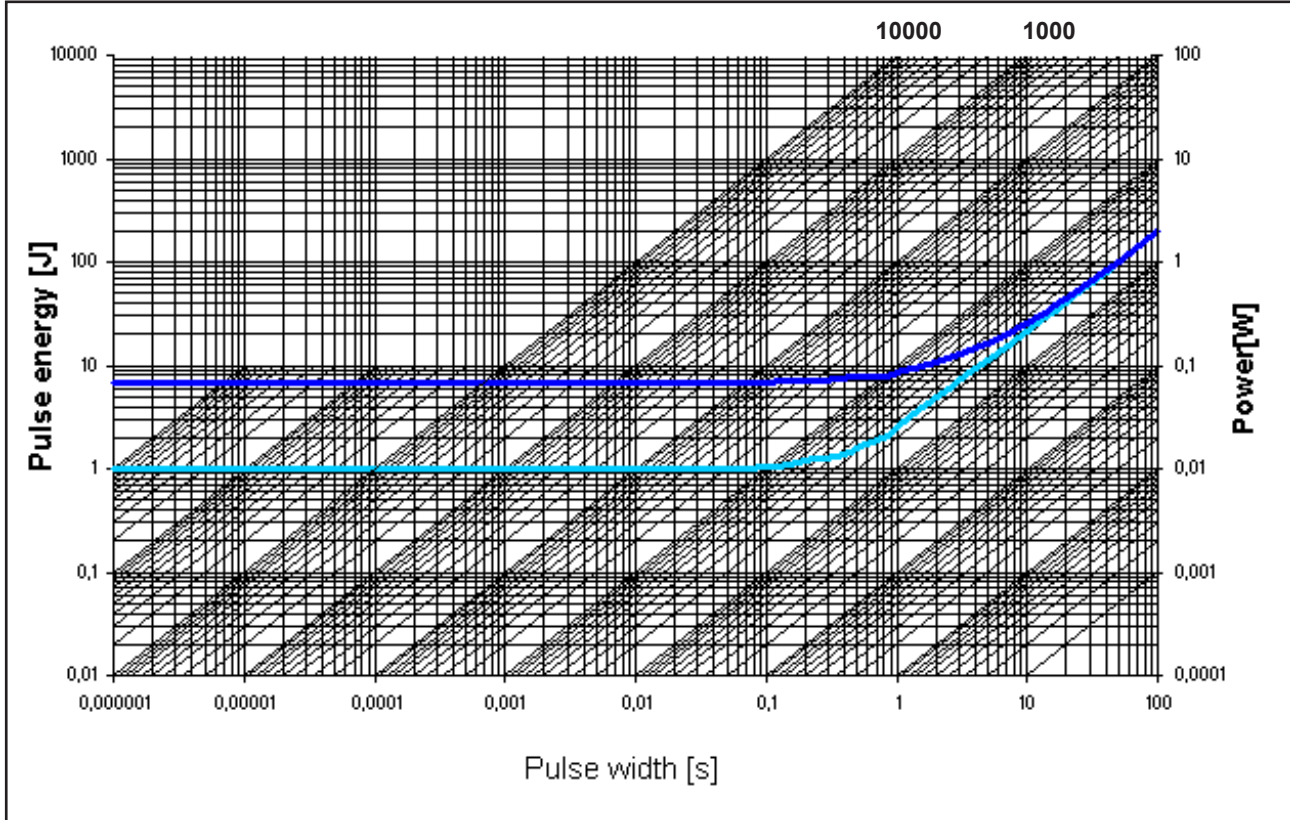

Die dargestellte Kurve gilt für den min. und max. Widerstandswert. Für andere Werte kann die Kurve im Bereich unter 0.1sec ggf. anders verlaufen, so dass in Grenzbereichen eine separate Qualifikation erfolgen sollte.

This curve is only valid for the min. and max. resistance value. The shape of the curve in the range below 0.1 sec will be different for resistance values inbetween. Therefore a separate qualification should be made for pulse power close to the above curve.

Spezifikation / Specification			
Parameters	Test Conditions	Specification	Typical data
Maximum Temperature for full power operation (2% stability)	125 °C	125 °C	125 °C
Working Temperature	-55 to 170 °C	-55 to 170 °C	-55 to 170 °C
Thermal Shock	MIL-STD-202 method 107-B1	0.1 %	0.05 %
Overload	MIL-R-26E (5 times rated power, 5 sec)	0.2 %	0.1 %
Solderability	MIL-STD-202 method 208	> 95 % coverage	> 95 % coverage
Resistance to Solvents	MIL-STD-202 method 215, 2.1a, 2.1d	no damage	no damage
Low Temperature Storage and Operation	MIL-STD-26E	0.1 %	0.03 %
Resistance to Soldering Heat	MIL-STD-202 method 210	0.1 %	0.02 %
Moisture Resistance	MIL-STD-202 method 106	0.1 %	0.01 %
Shock	MIL-STD-202 method 213-A	0.2 %	0.1 %
Life	MIL-STD-26E	0.2 %	0.05 %
Storage Life at Elevated Temperature	MIL-STD-202 method 108-F	0.3 %	0.1 %
High Temperature Exposure	140 °C, 2000 h	0.2 %	0.2 %
Current Noise	MIL-STD-202 method 308	0.01 %	0.001 %
Voltage Coefficient (%/V)	MIL-STD-202 method 309	linearity error less than 120dB	
Resistance Temperature Characteristic	MIL-STD-202 method 304 (20-60°C)	<50 ppm/K/<100 ppm/K	<50 ppm/K/<100 ppm/K
Thermal EMF	0 - 100 °C	4 µV/ K	2 µV/ K
Frequency Characteristic	inductivity	< 10 nH	< 3 nH