

INNOLUX DISPLAY CORPORATION

LCD MODULE SPECIFICATION

Customer: _____

Model Name: AT080TN04

SPEC NO.: A080-04-TT-03

Date: 2006/07/07

Version: 03

Preliminary Specification

Final Specification

For Customer's Acceptance

Approved by	Comment

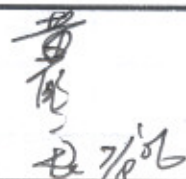
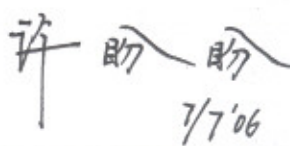
Approved by	Reviewed by	Prepared by
 林久华 2006.7.7	 黄 2006.7.7	 许 7/7'06

Record of Revision

Version	Revise Date	Page	Content
1	2006/05/10		Initial Release.
2	2006/6/5	20	Modify the Mechanical Drawing.
		8	Modify Power Voltage V_{GH} Typ. from "15.0 V" to "16.0v", and V_{GL} Typ. from "-10.0V" to "-7.0V".
		10	Add the Power Sequence.
3	2006/7/7	9	Modify Note 1 of Backlight Driving Conditions.

Contents

1.	General Specifications.....	1
2.	Pin Assignment.....	2
2.1.	TFT LCD Panel Driving Section.....	2
2.2.	Backlight Unit Section.....	6
3.	Operation Specifications.....	7
3.1.	Absolute Maximum Rating.....	7
3.1.1.	Typical Operation Conditions.....	8
3.1.2.	Current Consumption	9
3.1.3.	Backlight Driving Conditions.....	9
3.2.	Power Sequence	10
3.3.	Timing Characteristics	11
3.3.1.	Timing Conditions	11
3.3.2.	Timing Diagram	12
4.	Optical Specifications	15
5.	Reliability Test Items.....	19
6.	General Precautions.....	20
6.1.	Safety	20
6.2.	Handling	20
6.3.	Static Electricity	20
6.4.	Storage	20
6.5.	Cleaning	20
7.	Mechanical Drawing.....	21
8.	Package Drawing	22

1. General Specifications

No.	Item	Specification	Remark
1	LCD size	8.0 inch(Diagonal)	
2	Driver element	a-Si TFT active matrix	
3	Resolution	800X3(RGB)X600	
4	Display mode	Normally White, Transmissive	
5	Dot pitch	0.0675(W)X0.2025(H) mm	
6	Active area	162(W)X121.5(H) mm	
7	Module size	183(W)X141(H)X6.3(D) mm	Note 1
8	Surface treatment	Anti-Glare	
9	Color arrangement	RGB-stripe	
10	Interface	Digital	
11	Backlight Power consumption	TBD	
12	Panel Power consumption	TBD	
13	Weight	TBD	

Note 1: Refer to Mechanical Drawing.

2. Pin Assignment

2.1. TFT LCD Panel Driving Section

Pin No.	Symbol	I/O	Function	Remark
1	POL	I	Polarity selection	
2	STVD	I/O	Vertical start pulse input when U/D= H	Note 1
3	OEV	I	Output enable	
4	CKV	I	Vertical clock	
5	STVU	I/O	Vertical start pulse input when U/D= L	Note 1
6	GND	P	Power ground	
7	EDGSL	I	Select rising edge or falling edge	
8	V _{CC}	P	Power supply for digital circuit	
9	V9	I	Gamma voltage level 9	
10	V _{GL}	P	Gate OFF voltage	
11	V2	I	Gamma voltage level 2	
12	V _{GH}	P	Gate ON voltage	
13	V6	I	Gamma voltage level 6	
14	U/D	I	Up/down selection	Note 1, 2
15	V _{COM}	I	Common voltage	
16	GND	P	Power ground	
17	AV _{DD}	P	Power supply for analog circuit	
18	V14	I	Gamma voltage level 14	
19	V11	I	Gamma voltage level 11	
20	V8	I	Gamma voltage level 8	

21	V5	I	Gamma voltage level 5	
22	V3	I	Gamma voltage level 3	
23	GND	P	Power ground	
24	R5	I	Red data(MSB)	
25	R4	I	Red data	
26	R3	I	Red data	
27	R2	I	Red data	
28	R1	I	Red data	
29	R0	I	Red data(LSB)	
30	GND	P	Power ground	
31	GND	P	Power ground	
32	G5	I	Green data(MSB)	
33	G4	I	Green data	
34	G3	I	Green data	
35	G2	I	Green data	
36	G1	I	Green data	
37	G0	I	Green data(LSB)	
38	STHL	I/O	Horizontal start pulse input when R/L = H	Note 1
39	REV	I	Control signal are inverted or not	
40	GND	I	Power ground	
41	DCLK	I	Sample clock	
42	V _{CC}	P	Power supply for digital circuit	
43	STHR	I/O	Horizontal start pulse input when R/L = L	Note 1
44	LD	I	Latches the polarity of outputs and switches the new data to outputs	
45	B5	I	Blue data (MSB)	

46	B4	I	Blue data	
47	B3	I	Blue data	
48	B2	I	Blue data	
49	B1	I	Blue data	
50	B0	I	Blue data (LSB)	
51	R/L	I	Right/ left selection	Note 1, 2
52	V1	I	Gamma voltage level 1	
53	V4	I	Gamma voltage level 4	
54	V7	I	Gamma voltage level 7	
55	V10	I	Gamma voltage level 10	
56	V12	I	Gamma voltage level 12	
57	V13	I	Gamma voltage level 13	
58	AV _{DD}	P	Power supply for analog circuit	
59	GND	P	Power ground	
60	V _{COM}	I	Common voltage	

I: input, O: output, P: Power

Note 1: Selection of scanning mode

Setting of scan control input		IN/OUT state for start pulse				Scanning direction
U/D	R/L	STVD	STVU	STHR	STHL	
GND	V _{CC}	O	I	O	I	Up to down, left to right
V _{CC}	GND	I	O	I	O	Down to up, right to left
GND	GND	O	I	I	O	Up to down, right to left
V _{CC}	V _{CC}	I	O	O	I	Down to up, left to right

Note 2: Definition of scanning direction.
Refer to the figure as below:

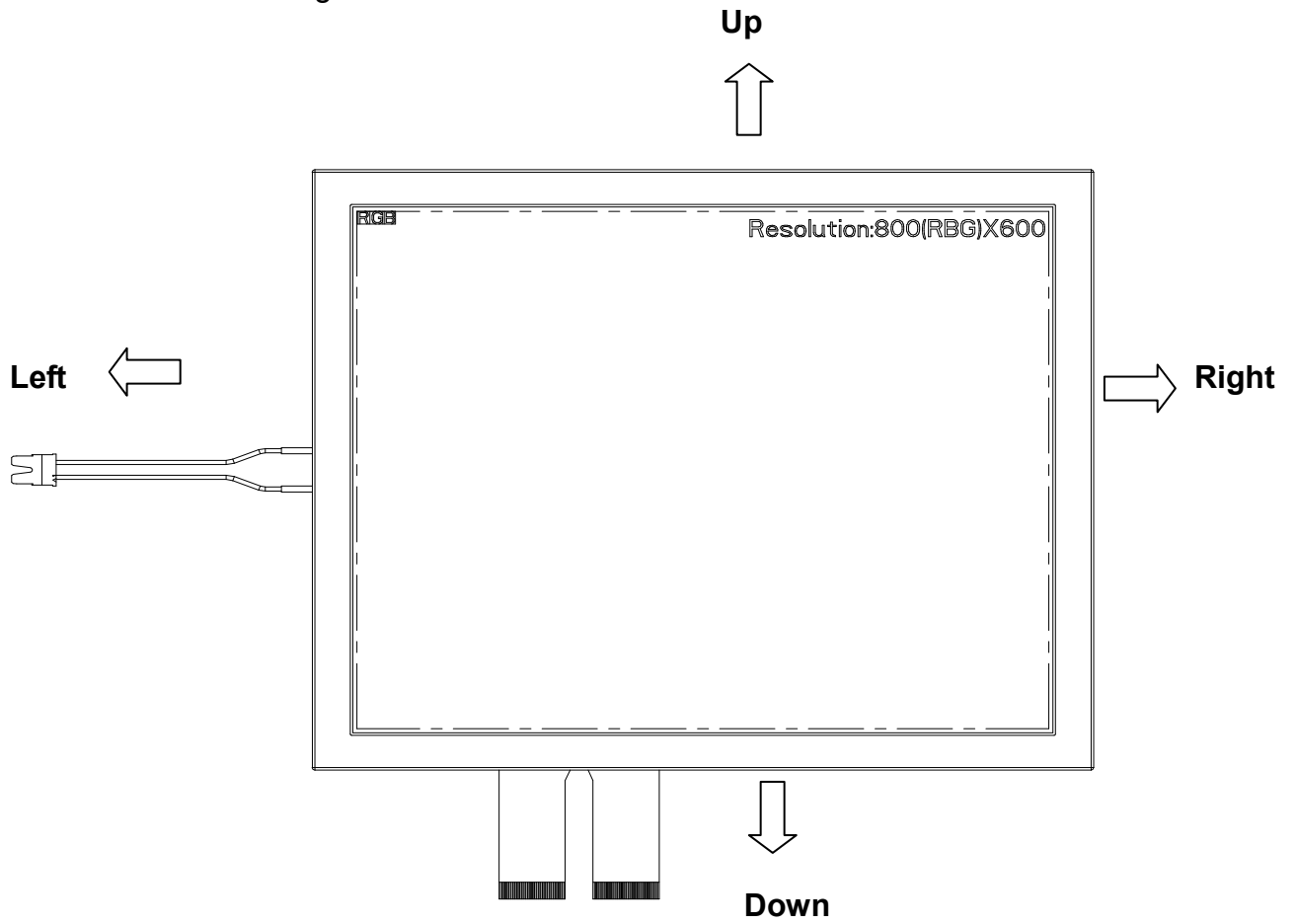

Note 3: When REV="L" , normally
REV="H", these data will be inverted.

2.2. Backlight Unit Section

Pin No.	Symbol	I/O	Function	Remark
1	HI	P	Power supply for backlight unit(High voltage)	Pink
2	GND	P	Ground for backlight unit	White

3. Operation Specifications

3.1. Absolute Maximum Rating

(GND=AV_{SS}=0V, Note 2)

Item	Symbol	Values		Unit	Remark
		Min.	Max.		
Power voltage	V _{CC}	-0.3	5.0	V	
	AV _{DD}	-0.5	13.5	V	
	V _{GH}	TBD	TBD	V	
	V _{GL}	TBD	TBD	V	
	V _{GH} -V _{GL}	-	33.0	V	
Input signal voltage	V1~V7	0.4 AV _{DD}	AV _{DD} +0.3	V	Note 1
	V8~V14	-0.3	0.6AV _{DD}	V	Note 1
Operation Temperature	T _{OP}	(-30)	(85)	°C	
Storage Temperature	T _{ST}	(-40)	(95)	°C	

Note 1: AV_{DD}-0.1 ≥ V1 ≥ V2 ≥ V3 ≥ V4 ≥ V5 ≥ V6 ≥ V7 ≥ V8 ≥ V9 ≥ V10 ≥ V11 ≥ V12 ≥ V13 ≥ V14 ≥ AV_{SS}+0.1

Note 2: The absolute maximum rating values of this product are not allowed to be exceeded at any times. Should a module be used with any of the absolute maximum ratings exceeded, the characteristics of the module may not be recovered, or in an extreme case, the module may be permanently destroyed.

3.1.1. Typical Operation Conditions

 (GND=AV_{SS}=0V, Note 1)

Item	Symbol	Values			Unit	Remark
		Min.	Typ.	Max.		
Power voltage	V _{CC}	3.0	3.3	3.6	V	Note 2
	AV _{DD}	-	10.0	-	V	
	V _{GH}	-	(16.0)	-	V	
	V _{GL}	-	(-7.0)	-	V	
Input signal voltage	V _{COM}	-	TBD	-	V	
	V1~V7	0.4 A _{VDD}	-	A _{VDD} -0.1	V	
	V8~V14	0.1	-	0.6 A _{VDD}	V	
Input logic high voltage	V _{IH}	0.7V _{CC}	-	V _{CC}	V	Note 3
Input logic low voltage	V _{IL}	0	-	0.3V _{CC}	V	

Note : Be sure to apply V_{CC} and V_{GL} to the LCD first, and then apply V_{GH}.

Note 2: V_{CC} setting should match the signals output voltage (refer to Note 3) of customer's system board .

Note 3: STHL, STHR, OEH, L/R, CPH1~CPH3, STVD, STVU, OEV, CKV, U/D.

3.1.2. Current Consumption

(GND=AV_{SS}=0V)

Item	Symbol	Values			Unit	Remark
		Min.	Typ.	Max.		
Current for Driver	I _{GH}	-	TBD	TBD	mA	V _{GH} =16.0V
	I _{GL}	-	TBD	TBD	mA	V _{GL} = -7.0V
	I _{CC}	-	TBD	TBD	mA	V _{CC} =3.3V
	I _{AV_{DD}}	-	TBD	TBD	mA	AV _{DD} =10.0V

3.1.3. Backlight Driving Conditions

Item	Symbol	Values			Unit	Remark
		Min.	Typ.	Max.		
LED voltage	V _L	-	9.9	10.5	V	Note 1
LED current	I _L	-	20	-	mA	Note 1
LED life time	-	20,000	-	-	Hr	Note 2

Note 1: The LED driving condition is defined for each LED module (3 LED Serial).

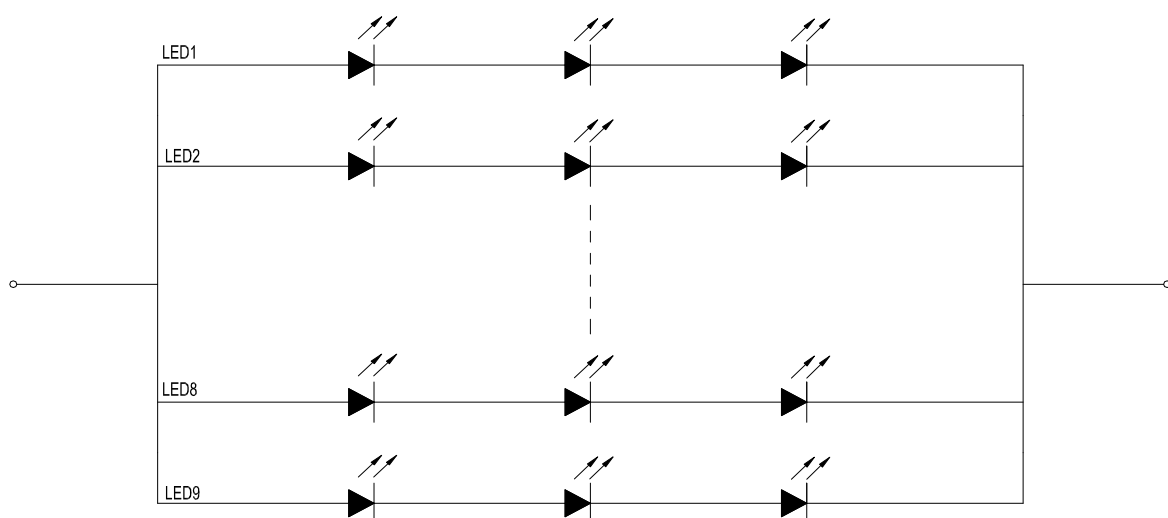

Note 2: The “LED life time” is defined as the module brightness decrease to 50% original brightness that the ambient temperature is 25°C and I_L =20mA.

The copyright belongs to InnoLux. Any unauthorized use is prohibited.

<http://www.BDTIC.com/INNOLUX>

3.2. Power Sequence

3.2.1. Power on:

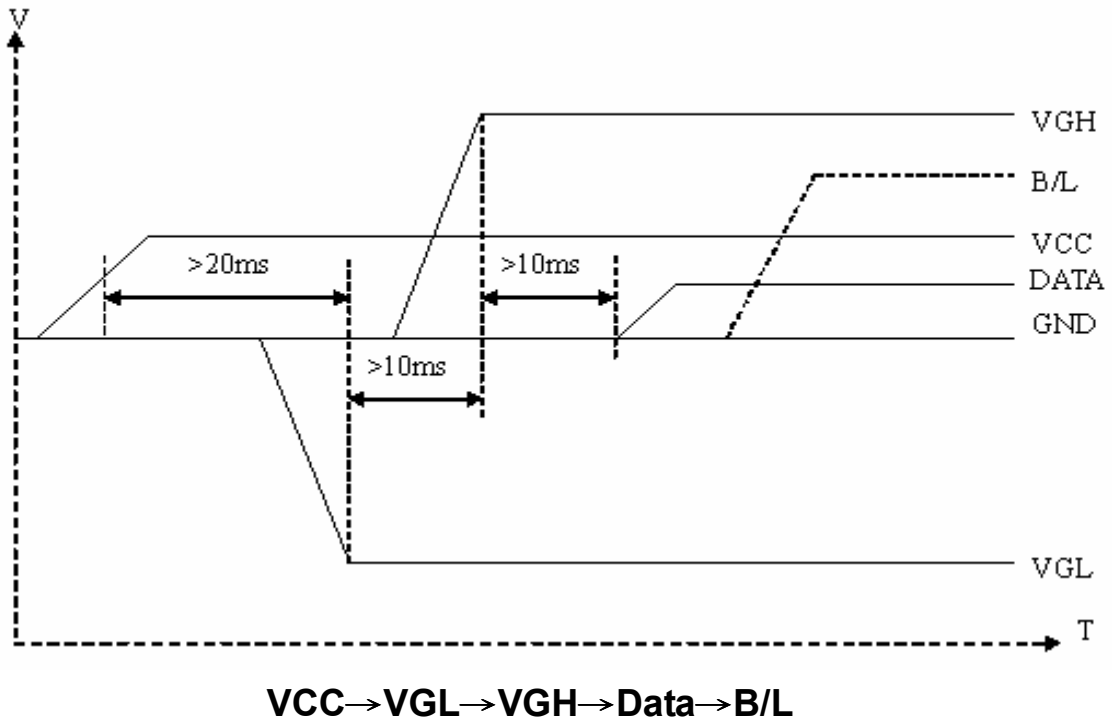

3.2.2. Power off:

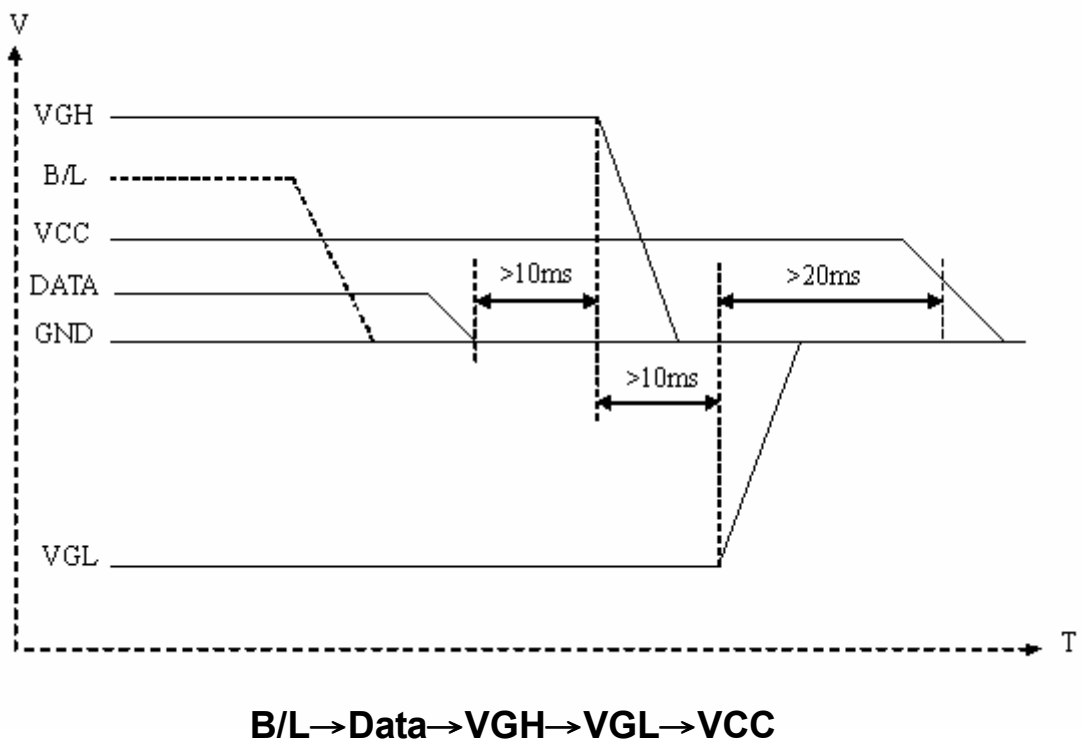

3.3. Timing Characteristics

3.3.1. Timing Conditions

Item	Symbol	Values			Unit	Remark
		Min.	Typ.	Max.		
DCLK frequency	Fclk	-	40	45	MHz	
DCLK cycle	Tcph	22	25	-	ns	
DCLK pulse width	Tcw	8	-	-	ns	
Data set-up time	Tsu	4	-	-	ns	
Data hold time	Thd	2	-	-	ns	
Time that the last data to LD	Tld	1	-	-	Tcph	
Pulse width of LD	Twld	2	-	-	Tcph	
Time that LD to STVD/U	Tlds	5	-	-	Tcph	
POL set-up time	Tpsu	6	-	-	ns	
POL hold time	Tphd	6	-	-	ns	
OEV pulse width	Toev	1	-	-	us	
CKV pulse width	Tckv	2.5	-	-	us	
Horizontal display timing range	Tdh	-	800	-	Tcph	
Horizontal timing range	Th	-	1056	-	Tcph	
STV setup time	Tsuv	700	-	-	ns	
STV hold time	Thdv	700	-	-	ns	
Horizontal lines per field	Tv	628	635	650	Tdh	
Vertical display timing range	Tvd	-	600	-	Tdh	

3.3.2. Timing Diagram

EDGSL=L or open

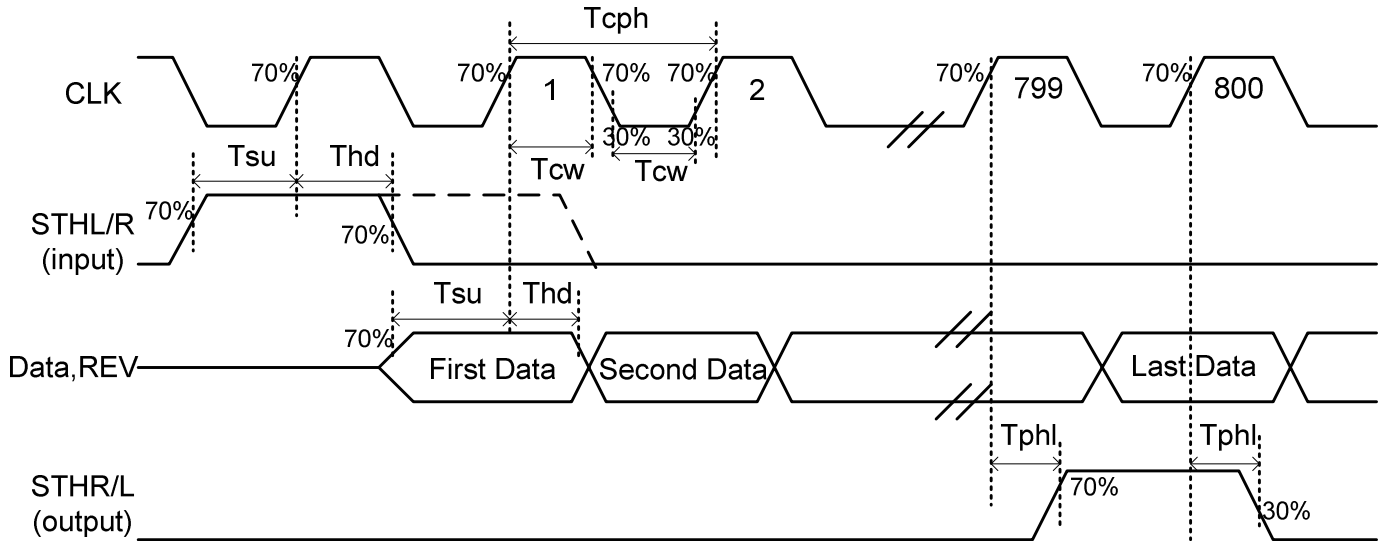

EDGSL=H

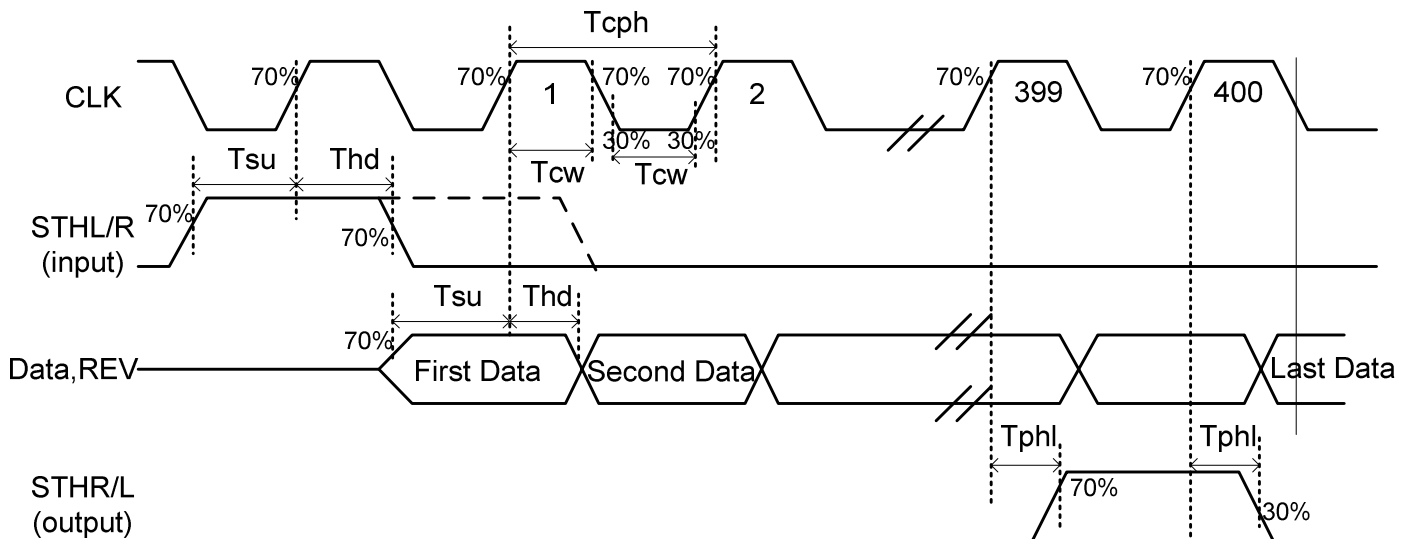

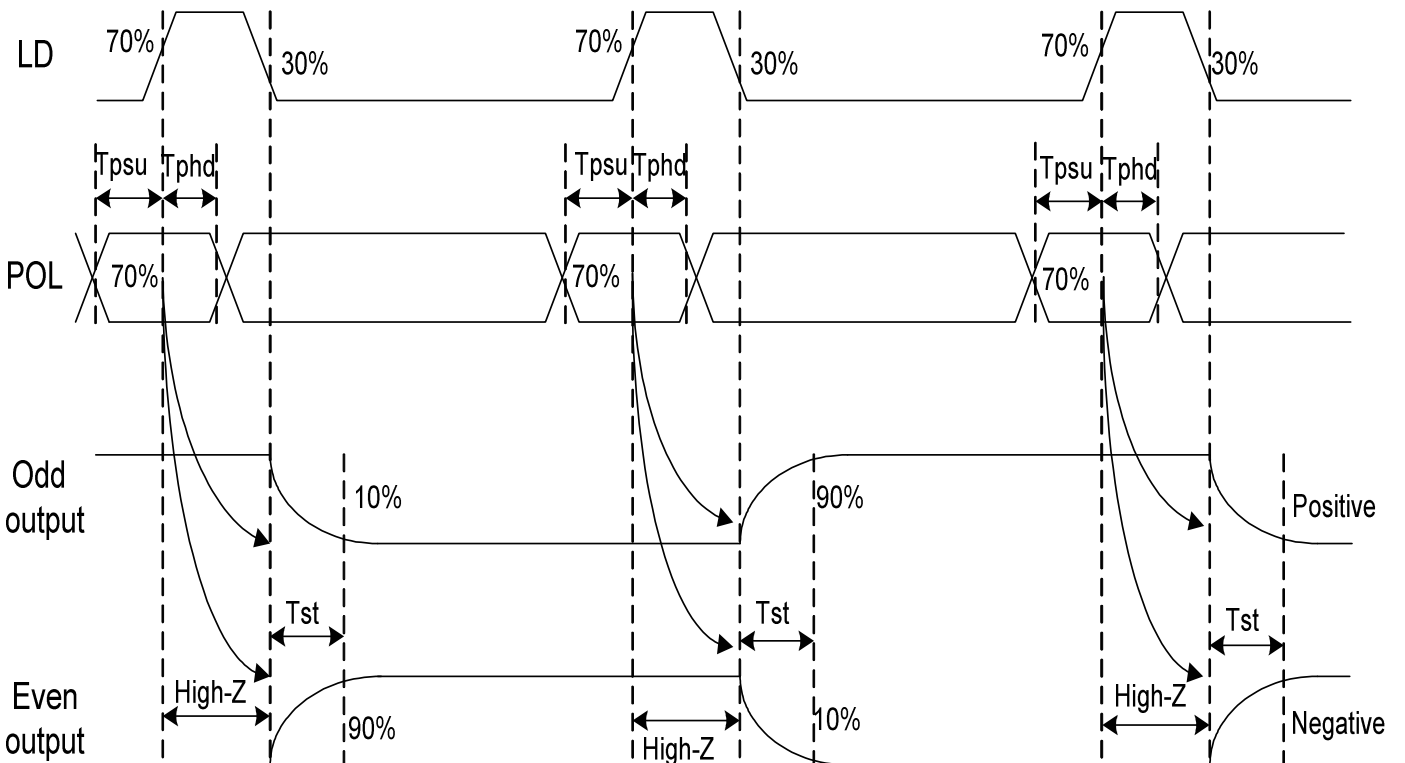
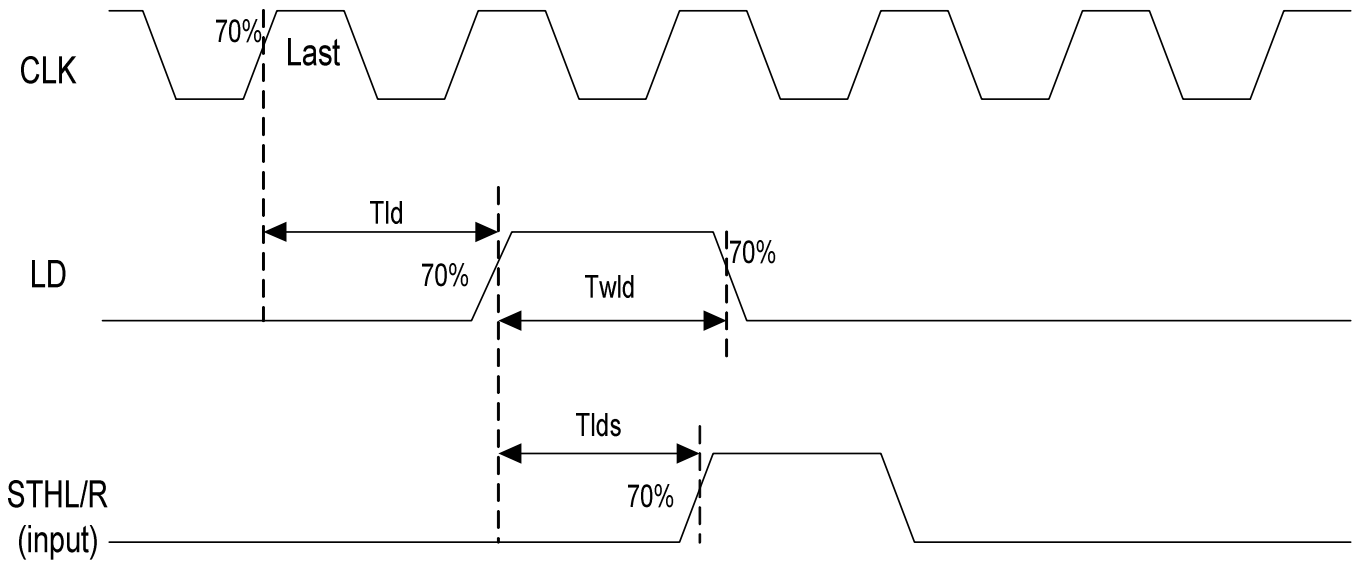

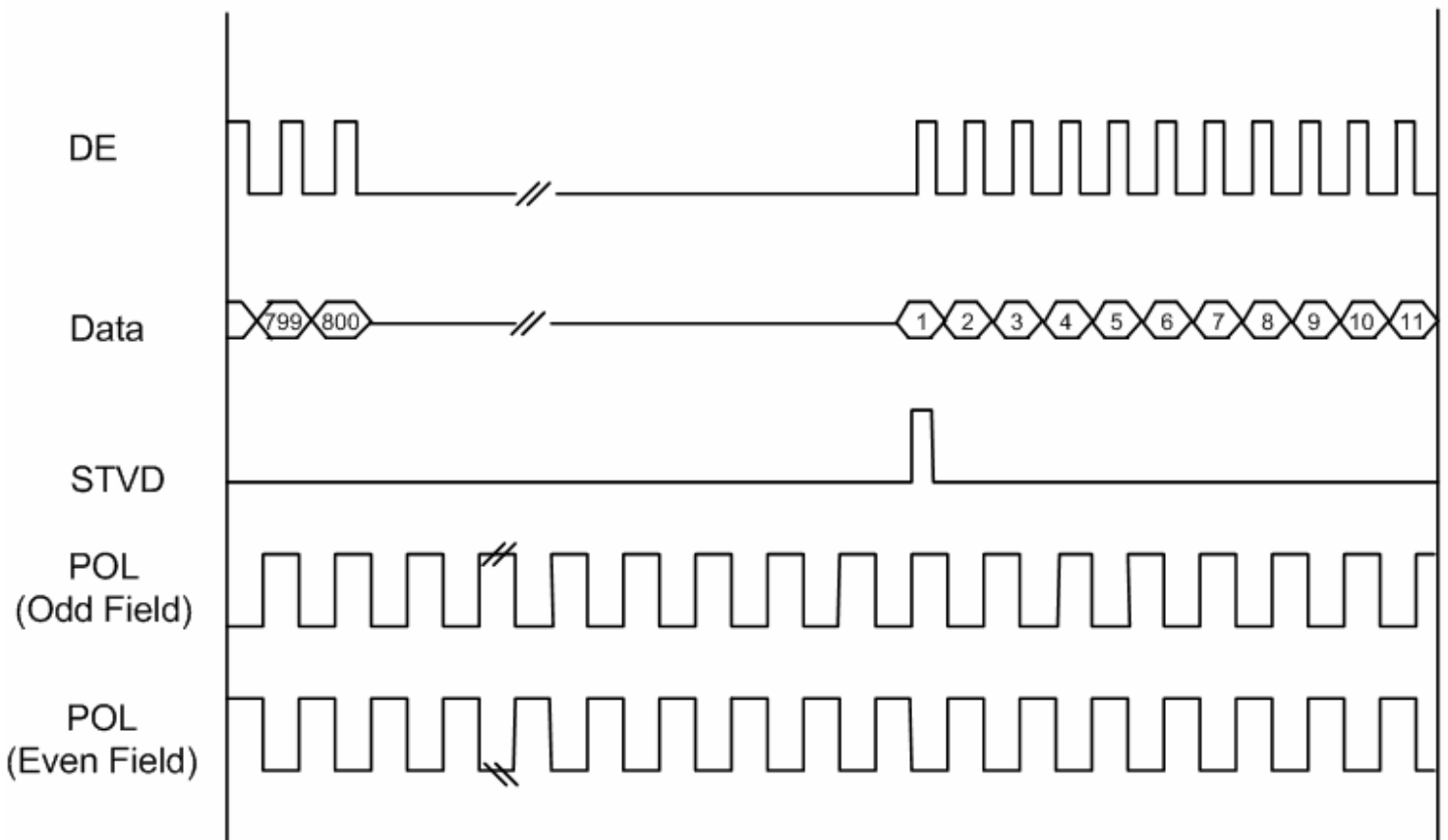
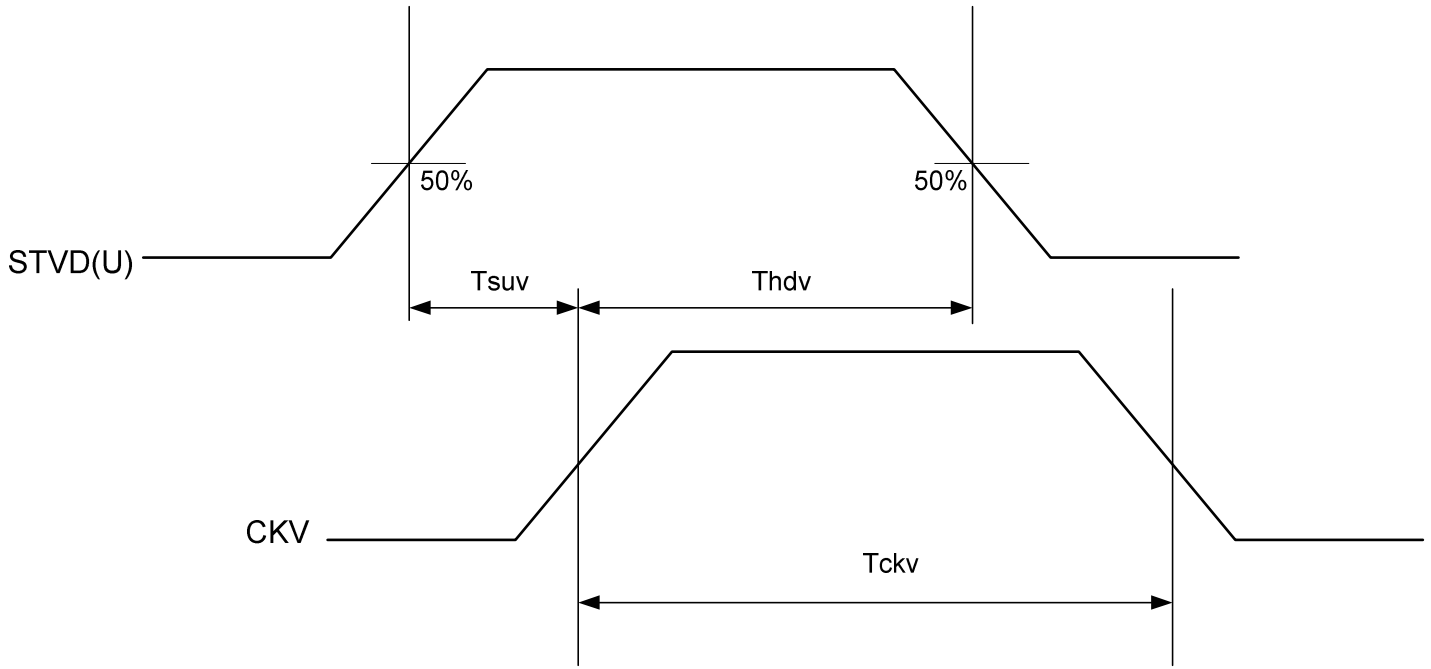

4. Optical Specifications

Item	Symbol	Condition	Values			Unit	Remark
			Min.	Typ.	Max.		
Viewing angle (CR≥ 10)	θ_L	$\Phi=180^\circ$ (9 o'clock)	(70)	(80)	-	degree	Note 1
	θ_R	$\Phi=0^\circ$ (3 o'clock)	(70)	(80)	-		
	θ_T	$\Phi=90^\circ$ (12 o'clock)	(70)	(80)	-		
	θ_B	$\Phi=270^\circ$ (6 o'clock)	(70)	(80)	-		
Response time	T_{ON}	Normal $\theta=\Phi=0^\circ$	-	(10)	TBD	msec	Note 3
	T_{OFF}		-	(15)	TBD	msec	Note 3
Contrast ratio	CR		(400)	(500)	-	-	Note 4
Color chromaticity	W_X		(0.26)	(0.31)	(0.36)	-	Note 2 Note 5 Note 6
	W_Y		(0.28)	(0.33)	(0.38)	-	
Luminance	L		300	(350)	-	cd/m ²	Note 6
Luminance uniformity	Y_U		70	75	-	%	Note 7

Test Conditions:

1. $V_{CC}=3.3V$, $I_L=20mA$ (Backlight current), the ambient temperature is $25^\circ C$.
2. The test systems refer to Note 2.

Note 1: Definition of viewing angle

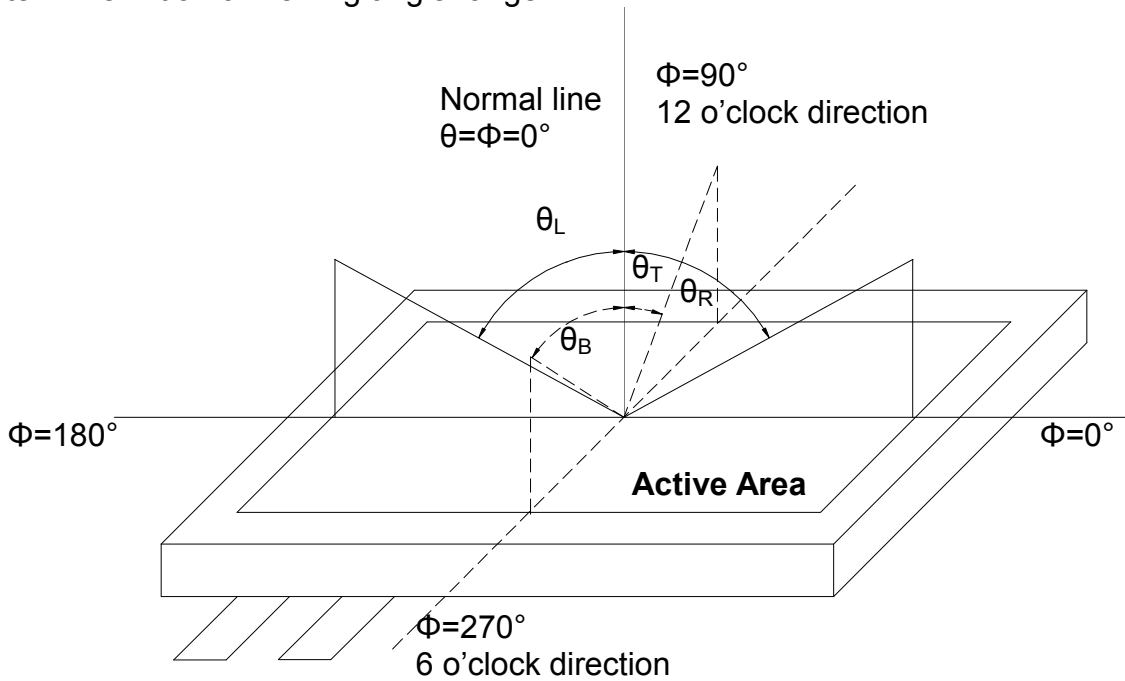

Fig. 4-1 Definition of viewing angle

Note 2: Definition of optical measurement system.

The optical characteristics should be measured in dark room. After 30 minutes operation, the optical properties are measured at the center point of the LCD screen. (Response time is measured by Photo detector TOPCON BM-7, other items are measured by BM-5A/Field of view: 1° /Height: 500mm.)

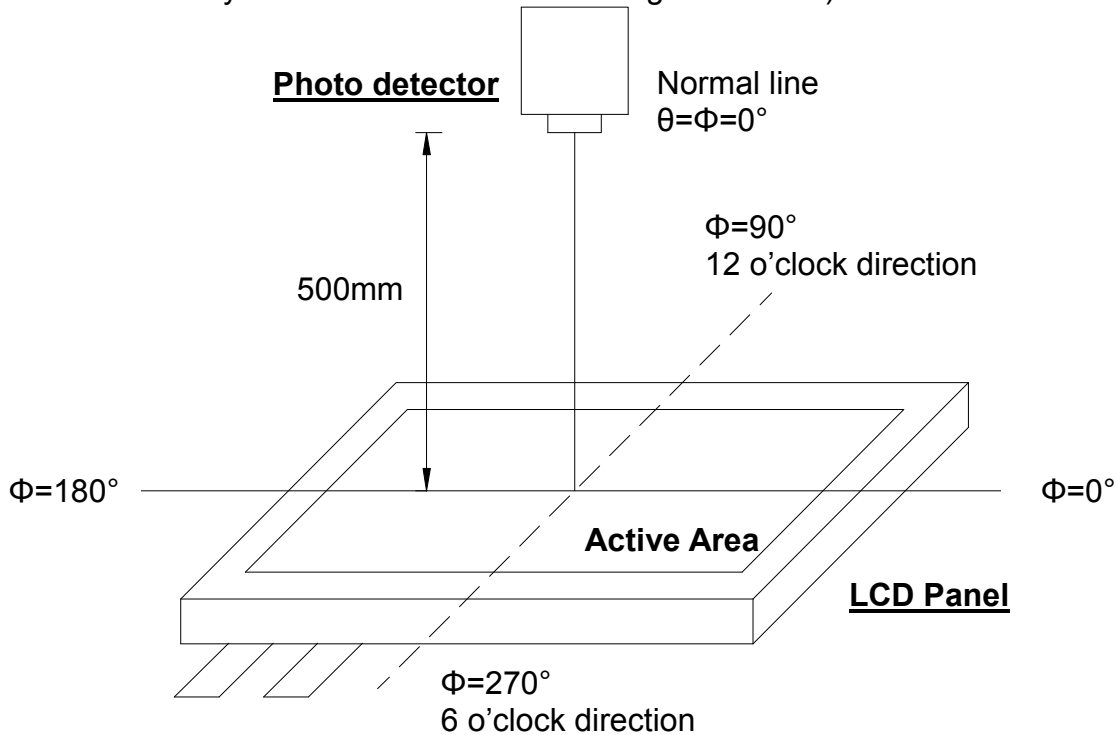

Fig. 4-2 Optical measurement system setup

The copyright belongs to InnoLux. Any unauthorized use is prohibited.

Note 3: Definition of Response time

The response time is defined as the LCD optical switching time interval between "White" state and "Black" state. Rise time (T_{ON}) is the time between photo detector output intensity changed from 90% to 10%. And fall time (T_{OFF}) is the time between photo detector output intensity changed from 10% to 90%.

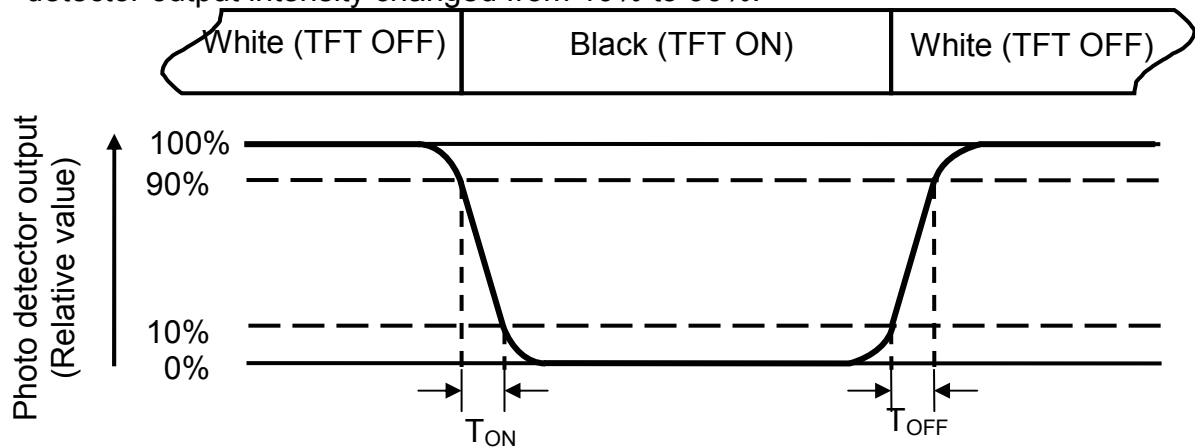

Fig. 4-3 Definition of response time

Note 4: Definition of contrast ratio

$$\text{Contrast ratio (CR)} = \frac{\text{Luminance measured when LCD on the "White" state}}{\text{Luminance measured when LCD on the "Black" state}}$$

Note 5: Definition of color chromaticity (CIE1931)

Color coordinates measured at center point of LCD.

Note 6: All input terminals LCD panel must be ground while measuring the center area of the panel.

Note 7: Definition of Luminance Uniformity

Active area is divided into 9 measuring areas (Refer to Fig. 4-4).Every measuring point is placed at the center of each measuring area.

$$\text{Luminance Uniformity (Yu)} = \frac{B_{min}}{B_{max}}$$

L-----Active area length W----- Active area width

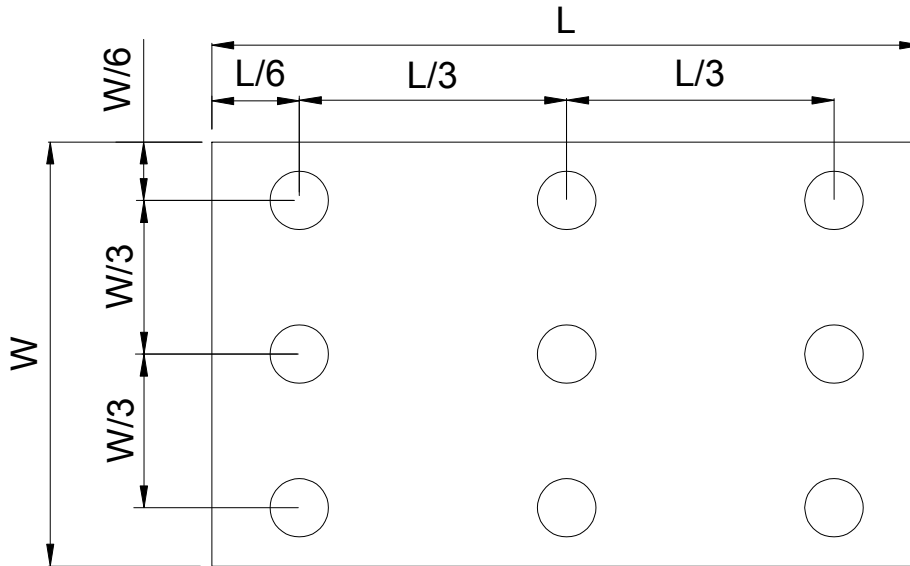

Fig. 4-4 Definition of measuring points

B_{max}: The measured maximum luminance of all measurement position.

B_{min}: The measured minimum luminance of all measurement position.

6. General Precautions

6.1. Safety

Liquid crystal is poisonous. Do not put it in your mouth. If liquid crystal touches your skin or clothes, wash it off immediately by using soap and water.

6.2. Handling

1. The LCD panel is plate glass. Do not subject the panel to mechanical shock or to excessive force on its surface.
2. The polarizer attached to the display is easily damaged. Please handle it carefully to avoid scratch or other damages.
3. To avoid contamination on the display surface, do not touch the module surface with bare hands.
4. Keep a space so that the LCD panels do not touch other components.
5. Put cover board such as acrylic board on the surface of LCD panel to protect panel from damages.
6. Transparent electrodes may be disconnected if you use the LCD panel under environmental conditions where the condensation of dew occurs.
7. Do not leave module in direct sunlight to avoid malfunction of the ICs.

6.3. Static Electricity

1. Be sure to ground module before turning on power or operating module.
2. Do not apply voltage which exceeds the absolute maximum rating value.

6.4. Storage

1. Store the module in a dark room where must keep at $25\pm 10^{\circ}\text{C}$ and 65%RH or less.
2. Do not store the module in surroundings containing organic solvent or corrosive gas.
3. Store the module in an anti-electrostatic container or bag.

6.5. Cleaning

1. Do not wipe the polarizer with dry cloth. It might cause scratch.
2. Only use a soft sloth with IPA to wipe the polarizer, other chemicals might permanent damage to the polarizer.

7. Mechanical Drawing

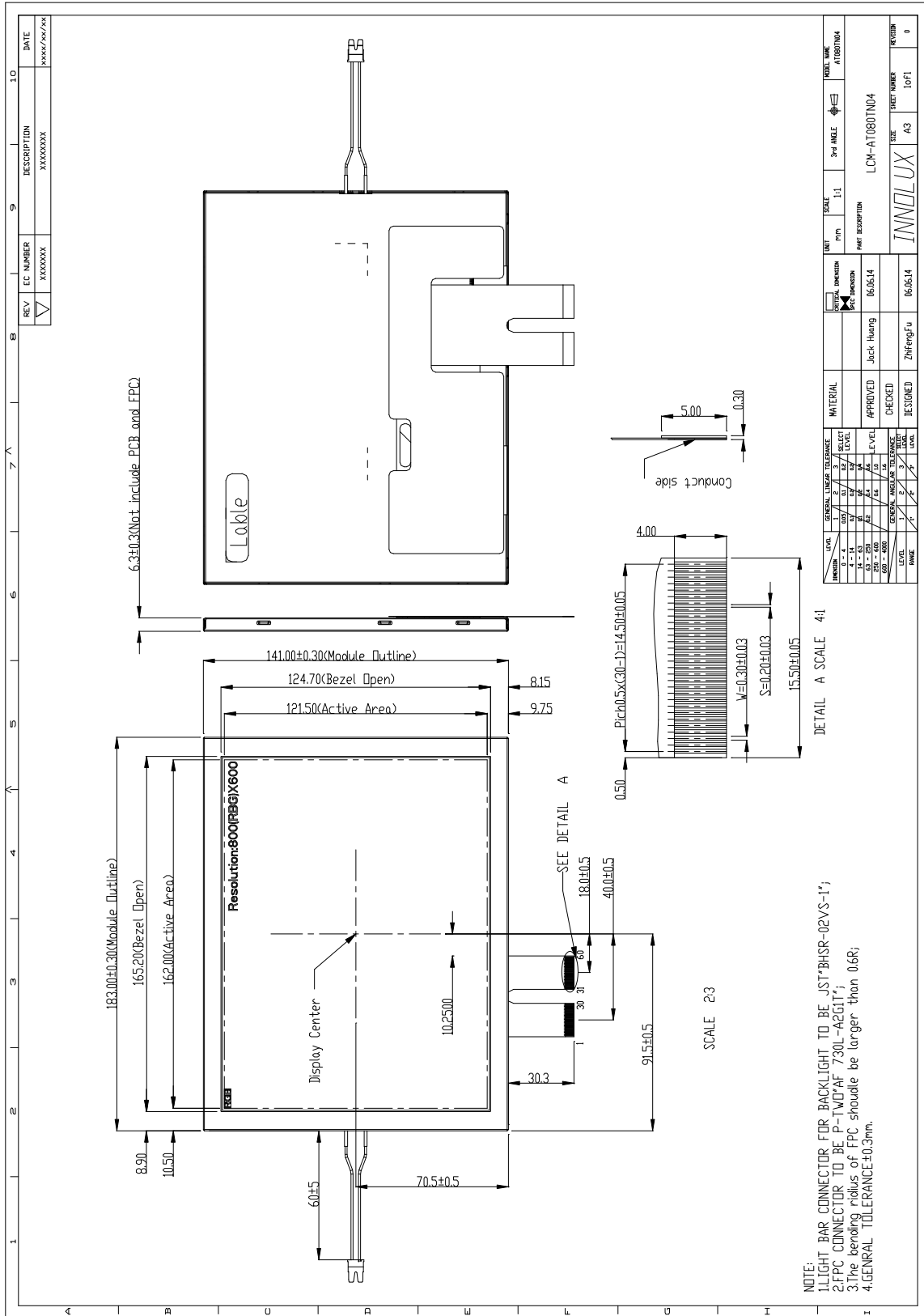

8. Package Drawing

TBD

<http://www.BDTIC.com/Innolux>

<http://www.BDTIC.com/INNOLUX>