







# INNOLUX DISPLAY CORPORATION

## MT190AW01 V.3 LCD MODULE SPECIFICATION

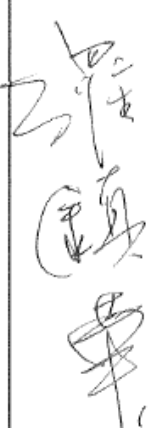
( ) Preliminary Specification

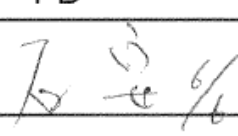
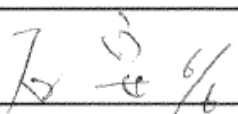
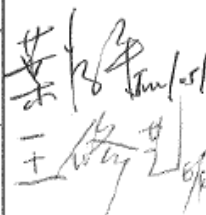
(●) Final Specification

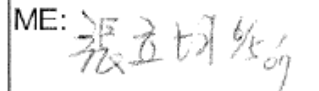
|          |                       |
|----------|-----------------------|
| Customer | Checked & Approved by |
|          |                       |

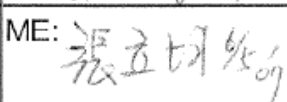
| Approved by  | Checked by  |   |  | Prepared by   |
|--|---|---|--|---|
| MKT  | QRA   | TD  | PD   | MKT   |
| <br> |  |  | PD Head:  | <br><br> |
|  |   |   | PDM:       |   |
|  |   |   | POFA:      |   |
|  |   |   | EE:        |   |
|  |   |   | ME:        |   |

**Innolux Display Corporation,**

No.160 Kesyue Rd., Chu-Nan Site, Hsinchu Science Park,

Chu-Nan 350 , Miao-Li County, Taiwan

Tel: 886-37-586000

Fax: 886-37-586060



|   |  |
|---|--|
| <b>Contents:</b>                        |  |
| <b>A. General Specification</b>         |  |
| <b>B. Electrical Specifications</b>     |  |
| 1. Pin assignment                       |  |
| 2. Absolute maximum ratings             |  |
| 3. Electrical characteristics           |  |
| a. Typical operating conditions         |  |
| b. Display color vs. input data signals |  |
| c. Input signal timing                  |  |
| d. Display position                     |  |
| e. Backlight driving conditions         |  |
| <b>C. Optical specifications</b>        |  |
| <b>D. Reliability test items</b>        |  |
| <b>E. Safety</b>                        |  |
| <b>F. Display quality</b>               |  |
| <b>G. Handling precaution</b>           |  |
| <b>H. Label</b>                         |  |
| <b>I. Mechanical drawings</b>           |  |
| <b>Appendix</b>                         |  |
|   |  |

**A. General specification**

| NO. | Item                       | Specification                       | Remark |
|-----|----------------------------|-------------------------------------|--------|
| 1   | Display resolution (pixel) | 1,440(H) X 900(V), WXGA+ resolution |        |
| 2   | Active area (mm)           | 410.4(H) X 256.5(V)                 |        |
| 3   | Screen size (inch)         | 19 inches diagonal                  |        |
| 4   | Pixel pitch (mm)           | 0.285(H) X 0.285(V)                 |        |
| 5   | Color configuration        | R, G, B vertical stripe             |        |
| 6   | Overall dimension (mm)     | 427.2(W) X 277.4(H) X 16(D) (Typ.)  |        |
| 7   | Weight (g)                 | 2200 (max)                          |        |
| 8   | Surface treatment          | Glare, Hard coating (3H)            |        |
| 9   | Input color signal         | 8 bit LVDS                          |        |
| 10  | Display colors             | 16.7M (6 bit with Hi-FRC)           |        |
| 11  | Optimum viewing direction  | 6 o'clock                           |        |
| 12  | Backlight                  | 4 CCFL                              |        |
| 13  | TCO'03 & RoHS              | RoHS compliance                     |        |

**B. Electrical specifications**

## 1.Pin assignment

**Connector**

JAE FI-X30SSL-HF or mechanical interface equivalent connector.

| Pin No | Symbol  | Description                                |
|--------|---------|--|
| Frame  | VSS     | Ground                                     |
| 1      | RXinO0- | -LVDS differential data input, Chan 0-Odd  |
| 2      | RXinO0+ | +LVDS differential data input, Chan 0-Odd  |
| 3      | RXinO1- | -LVDS differential data input, Chan 1-Odd  |
| 4      | RXinO1+ | +LVDS differential data input, Chan 1-Odd  |
| 5      | RXinO2- | -LVDS differential data input, Chan 2-Odd  |
| 6      | RXinO2+ | +LVDS differential data input, Chan 2-Odd  |
| 7      | VSS     | Ground                                     |
| 8      | RXOC-   | -LVDS differential Clock input (Odd)       |
| 9      | RXOC+   | +LVDS differential Clock input (Odd)       |
| 10     | RXinO3- | -LVDS differential data input, Chan 3-Odd  |
| 11     | RXinO3+ | +LVDS differential data input, Chan 3-Odd  |
| 12     | RXinE0- | -LVDS differential data input, Chan 0-Even |
| 13     | RXinE0+ | +LVDS differential data input, Chan 0-Even |
| 14     | VSS     | Ground                                     |
| 15     | RXinE1- | -LVDS differential data input, Chan 1-Even |
| 16     | RXinE1+ | +LVDS differential data input, Chan 1-Even |
| 17     | VSS     | Ground                                     |
| 18     | RXinE2- | -LVDS differential data input, Chan 2-Even |
| 19     | RXinE2+ | +LVDS differential data input, Chan 2-Even |
| 20     | RXEC-   | -LVDS differential Clock input (Even)      |
| 21     | RXEC+   | +LVDS differential Clock input (Even)      |
| 22     | RXinE3- | -LVDS differential data input, Chan 3-Even |
| 23     | RXinE3+ | +LVDS differential data input, Chan 3-Even |
| 24     | VSS     | Ground                                     |
| 25     | VSS     | Ground                                     |
| 26     | NC      | No Connection                              |
| 27     | VSS     | Ground                                     |
| 28     | VCC     | +5.0V power supply                         |
| 29     | VCC     | +5.0V power supply                         |
| 30     | VCC     | +5.0V power supply                         |
| Frame  | VSS     | Ground                                     |



Rear view of LCM

2. Absolute maximum ratings

| Parameter             | Symbol   | Values |      |      | Unit | Remark  |
|-----------------------|----------|--------|------|------|------|---------|
|                       |          | Min.   | Typ. | Max. |      |         |
| Power voltage         | $V_{CC}$ | -0.3   | -    | 6.0  | V    | At 25°C |
| Input signal voltage  | $V_{LH}$ | -0.3   | -    | 4.3  | V    | At 25°C |
| Operating temperature | $T_{OP}$ | 0      | -    | 50   | °C   | Note 1  |
| Storage temperature   | $T_{ST}$ | -25    | -    | 60   | °C   | Note 2  |
| CCFL Current          | ICFL     | 2      | 7    | 7.5  | [mA] |         |

Note 1: The relative humidity must not exceed 90% non-condensing at temperatures of 40°C or less.

At temperatures greater than 40°C, the wet bulb temperature must not exceed 39°C.

Note 2: The unit should not be exposed to corrosive chemicals.

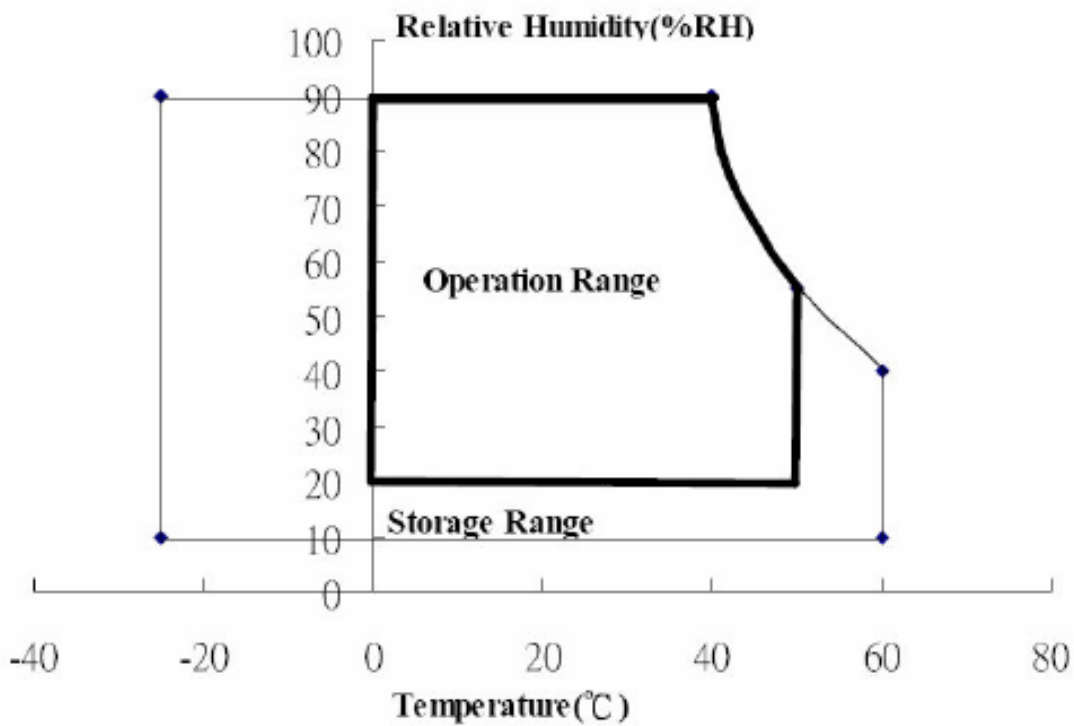

## 3. Electrical characteristics

## a. Typical operating conditions

| Item  |                            | Symbol     | Min. | Typ. | Max. | Unit | Remark |
|---|----------------------------|------------|------|------|------|------|--------|
| Input Voltage                               |                            | $V_{CC}$   | 4.5  | 5    | 5.5  | V    |        |
| Permissive Power Input Ripple               |                            | $V_{RF}$   | -    | -    | 0.15 | V    |        |
| Input Current                               | Black                      | $I_{CC}$   | -    | 700  | 1000 | mA   | Note 1 |
|   | White                      | $I_{CC}$   | -    | 500  | 700  |      | Note 2 |
|   | Mosaic                     | $I_{CC}$   | -    | 700  | 1000 |      | Note 3 |
| Rush Current                                |                            | $I_{Rush}$ | -    | 1.6  | 3    | A    | Note 4 |
| Logic Input<br>Voltage<br>LVDS:<br>IN+, IN- | Common Mode Voltage        | VCM        | -    | 1.2  | -    | V    |        |
|   | Differential Input Voltage | VID        | 100  | -    | 600  | mV   |        |
|   | Threshold Voltage (High)   | VTH        | -    | -    | 100  | mV   | Note 5 |
|   | Threshold Voltage (Low)    | VTL        | -100 | -    | -    | mV   | Note 5 |

Note 1 : The specified current is under the  $V_{CC} = 5V$ ,  $25^{\circ}C$ ,  $f_v = 60Hz$  (frame frequency) condition whereas black pattern is displayed.

Note 2 : The specified current is under the  $V_{CC} = 5V$ ,  $25^{\circ}C$ ,  $f_v = 60Hz$  (frame frequency) condition whereas white pattern is displayed.

Note 3 : The specified current is under the  $V_{CC} = 5V$ ,  $25^{\circ}C$ ,  $f_v = 60Hz$  (frame frequency) condition whereas mosaic pattern (black & white [8\*6]) is displayed.

White : 255 Gray

Black : 0 Gray

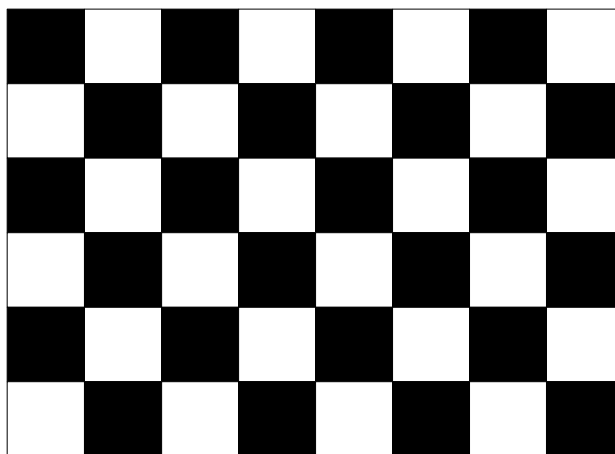



Note 4 : test condition :

- (1)  $V_{DD} = 5\text{ V}$ ,  $V_{DD}$  rising time =  $470\ \mu\text{s} \pm 10\%$
- (2) Pattern: Mosaic pattern

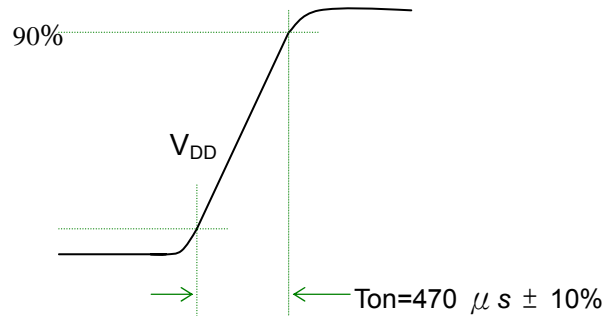

(3) Test circuit

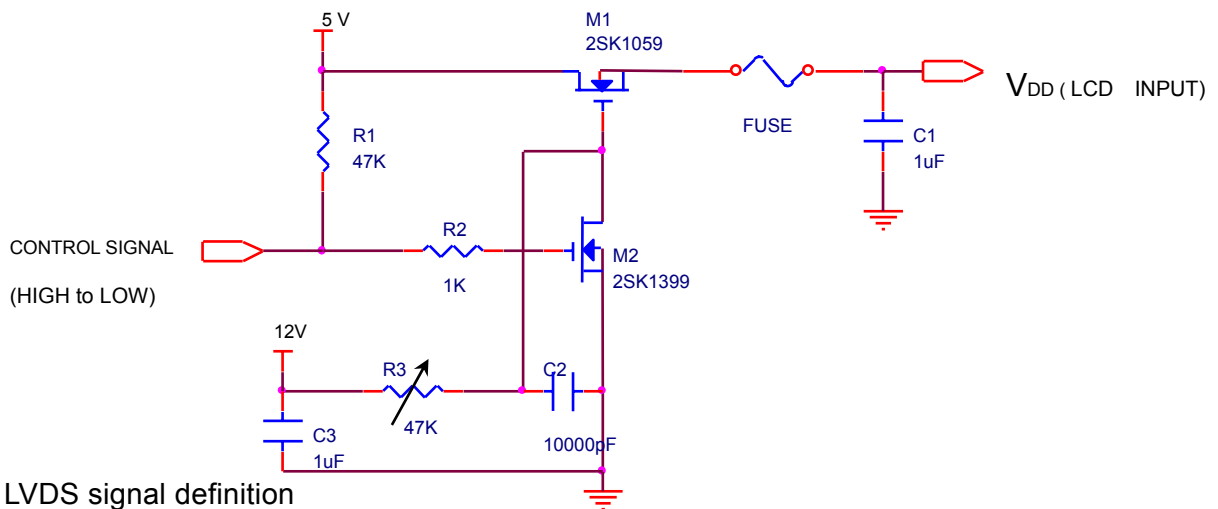

Note 5: LVDS signal definition

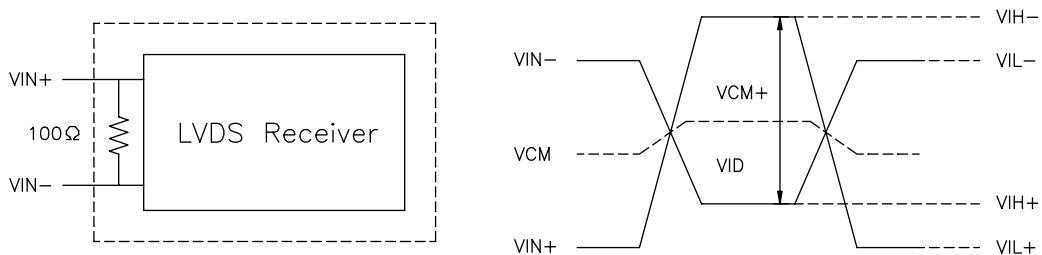

- $VIN_+$  = Positive differential DATA & CLK Input
- $VIN_-$  = Negative differential DATA & CLK Input
- $VID = VIN_+ - VIN_-$ ,
- $\Delta VCM = |VCM_+ - VCM_-|$ ,
- $\Delta VID = |VID_+ - VID_-|$ ,
- $VID_+ = |VIH_+ - VIH_-|$ ,
- $VID_- = |VIL_+ - VIL_-|$ ,
- $VCM = (VIN_+ + VIN_-)/2$ ,
- $VCM_+ = (VIH_+ + VIH_-)/2$ ,
- $VCM_- = (VIL_+ + VIL_-)/2$ ,

Note 6 : Power on sequence for LCD V<sub>DD</sub>

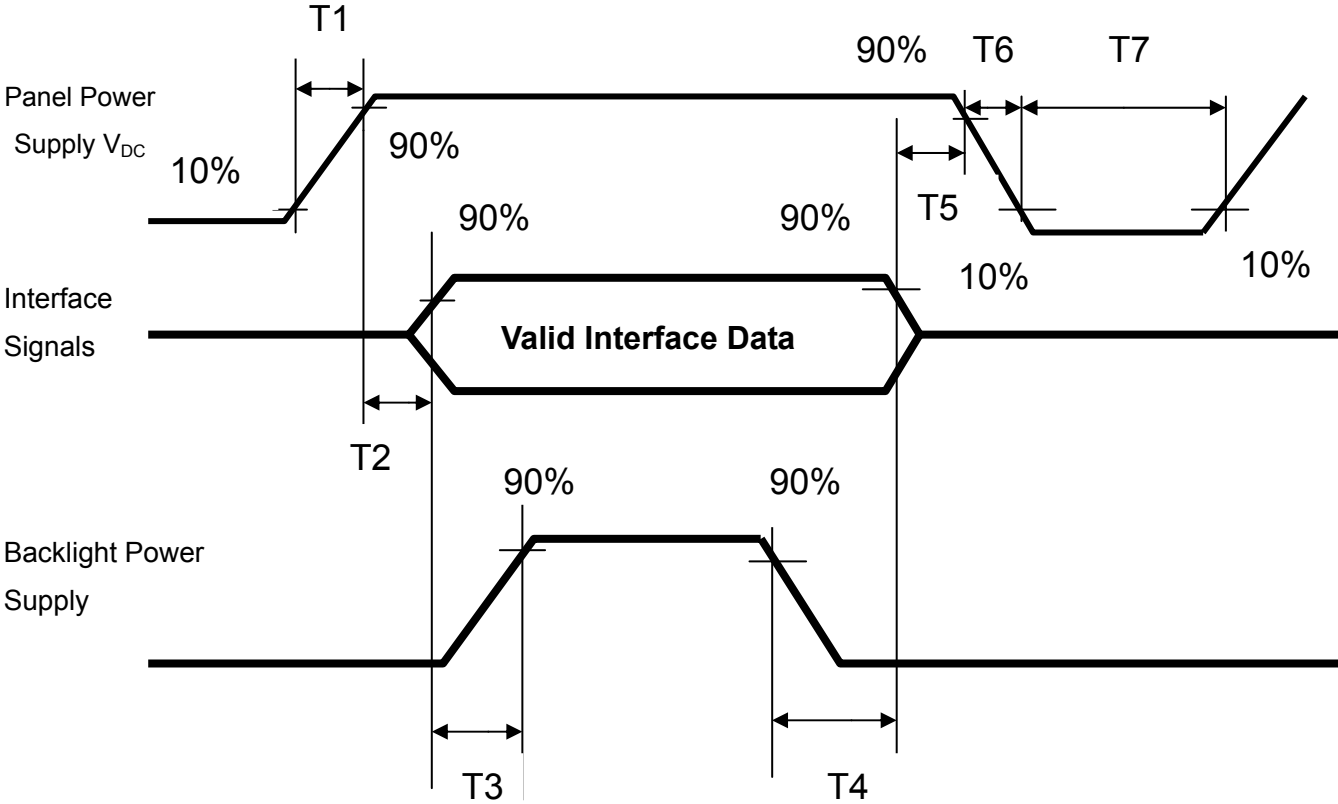

| Parameter | Value |     |     | Unit |
|-----------|-------|-----|-----|------|
|           | Min   | Typ | Max |      |
| T1        | 0.1   | -   | 10  | ms   |
| T2        | 0     | 30  | 50  | ms   |
| T3        | 200   | 250 | -   | ms   |
| T4        | 100   | 250 | -   | ms   |
| T5        | 0     | 20  | 50  | ms   |
| T6        | 0.1   | -   | -   | ms   |
| T7        | 1000  | -   | -   | ms   |

b. Display color vs. input data signals

The brightness of each primary color (red, green and blue) is based on the 8-bit gray scale data input for the color; the higher the binary input, the brighter the color. The table below provides a reference for color versus data input.

| Color        | Input color data |    |    |    |     |    |    |    |       |    |    |    |     |    |    |    |      |    |    |    |     |    |    |    |
|--------------|------------------|----|----|----|-----|----|----|----|-------|----|----|----|-----|----|----|----|------|----|----|----|-----|----|----|----|
|              | Red              |    |    |    |     |    |    |    | Green |    |    |    |     |    |    |    | Blue |    |    |    |     |    |    |    |
|              | MSB              |    |    |    | LSB |    |    |    | MSB   |    |    |    | LSB |    |    |    | MSB  |    |    |    | LSB |    |    |    |
|              | R7               | R6 | R5 | R4 | R3  | R2 | R1 | R0 | G7    | G6 | G5 | G4 | G3  | G2 | G1 | G0 | B7   | B6 | B5 | B4 | B3  | B2 | B1 | B0 |
| Basic colors | Black            | 0  | 0  | 0  | 0   | 0  | 0  | 0  | 0     | 0  | 0  | 0  | 0   | 0  | 0  | 0  | 0    | 0  | 0  | 0  | 0   | 0  | 0  | 0  |
|              | Red(255)         | 1  | 1  | 1  | 1   | 1  | 1  | 1  | 1     | 0  | 0  | 0  | 0   | 0  | 0  | 0  | 0    | 0  | 0  | 0  | 0   | 0  | 0  | 0  |
|              | Green(255)       | 0  | 0  | 0  | 0   | 0  | 0  | 0  | 0     | 1  | 1  | 1  | 1   | 1  | 1  | 1  | 0    | 0  | 0  | 0  | 0   | 0  | 0  | 0  |
|              | Blue(255)        | 0  | 0  | 0  | 0   | 0  | 0  | 0  | 0     | 0  | 0  | 0  | 0   | 0  | 0  | 0  | 1    | 1  | 1  | 1  | 1   | 1  | 1  | 1  |
|              | Cyan             | 0  | 0  | 0  | 0   | 0  | 0  | 0  | 0     | 1  | 1  | 1  | 1   | 1  | 1  | 1  | 1    | 1  | 1  | 1  | 1   | 1  | 1  | 1  |
|              | Magenta          | 1  | 1  | 1  | 1   | 1  | 1  | 1  | 1     | 0  | 0  | 0  | 0   | 0  | 0  | 0  | 1    | 1  | 1  | 1  | 1   | 1  | 1  | 1  |
|              | Yellow           | 1  | 1  | 1  | 1   | 1  | 1  | 1  | 1     | 1  | 1  | 1  | 1   | 1  | 1  | 1  | 0    | 0  | 0  | 0  | 0   | 0  | 0  | 0  |
|              | White            | 1  | 1  | 1  | 1   | 1  | 1  | 1  | 1     | 1  | 1  | 1  | 1   | 1  | 1  | 1  | 1    | 1  | 1  | 1  | 1   | 1  | 1  | 1  |
| Red          | Red(000) dark    | 0  | 0  | 0  | 0   | 0  | 0  | 0  | 0     | 0  | 0  | 0  | 0   | 0  | 0  | 0  | 0    | 0  | 0  | 0  | 0   | 0  | 0  | 0  |
|              | Red(001)         | 0  | 0  | 0  | 0   | 0  | 0  | 0  | 1     | 0  | 0  | 0  | 0   | 0  | 0  | 0  | 0    | 0  | 0  | 0  | 0   | 0  | 0  | 0  |
|              | Red(002)         | 0  | 0  | 0  | 0   | 0  | 0  | 1  | 0     | 0  | 0  | 0  | 0   | 0  | 0  | 0  | 0    | 0  | 0  | 0  | 0   | 0  | 0  | 0  |
|              | :                | :  | :  | :  | :   | :  | :  | :  | :     | :  | :  | :  | :   | :  | :  | :  | :    | :  | :  | :  | :   | :  | :  | :  |
|              | Red(253)         | 1  | 1  | 1  | 1   | 1  | 1  | 0  | 1     | 0  | 0  | 0  | 0   | 0  | 0  | 0  | 0    | 0  | 0  | 0  | 0   | 0  | 0  | 0  |
|              | Red(254)         | 1  | 1  | 1  | 1   | 1  | 1  | 1  | 0     | 0  | 0  | 0  | 0   | 0  | 0  | 0  | 0    | 0  | 0  | 0  | 0   | 0  | 0  | 0  |
|              | Red(255) bright  | 1  | 1  | 1  | 1   | 1  | 1  | 1  | 1     | 0  | 0  | 0  | 0   | 0  | 0  | 0  | 0    | 0  | 0  | 0  | 0   | 0  | 0  | 0  |
| Green        | Green(000)dark   | 0  | 0  | 0  | 0   | 0  | 0  | 0  | 0     | 0  | 0  | 0  | 0   | 0  | 0  | 0  | 0    | 0  | 0  | 0  | 0   | 0  | 0  | 0  |
|              | Green(001)       | 0  | 0  | 0  | 0   | 0  | 0  | 0  | 0     | 0  | 0  | 0  | 0   | 0  | 0  | 1  | 0    | 0  | 0  | 0  | 0   | 0  | 0  | 0  |
|              | Green(002)       | 0  | 0  | 0  | 0   | 0  | 0  | 0  | 0     | 0  | 0  | 0  | 0   | 0  | 1  | 0  | 0    | 0  | 0  | 0  | 0   | 0  | 0  | 0  |
|              | :                | :  | :  | :  | :   | :  | :  | :  | :     | :  | :  | :  | :   | :  | :  | :  | :    | :  | :  | :  | :   | :  | :  | :  |
|              | Green(253)       | 0  | 0  | 0  | 0   | 0  | 0  | 0  | 0     | 1  | 1  | 1  | 1   | 1  | 1  | 0  | 1    | 0  | 0  | 0  | 0   | 0  | 0  | 0  |
|              | Green(254)       | 0  | 0  | 0  | 0   | 0  | 0  | 0  | 0     | 1  | 1  | 1  | 1   | 1  | 1  | 1  | 0    | 0  | 0  | 0  | 0   | 0  | 0  | 0  |
|              | Green(255)bright | 0  | 0  | 0  | 0   | 0  | 0  | 0  | 0     | 1  | 1  | 1  | 1   | 1  | 1  | 1  | 0    | 0  | 0  | 0  | 0   | 0  | 0  | 0  |
| Blue         | Blue(000) dark   | 0  | 0  | 0  | 0   | 0  | 0  | 0  | 0     | 0  | 0  | 0  | 0   | 0  | 0  | 0  | 0    | 0  | 0  | 0  | 0   | 0  | 0  | 0  |
|              | Blue(001)        | 0  | 0  | 0  | 0   | 0  | 0  | 0  | 0     | 0  | 0  | 0  | 0   | 0  | 0  | 0  | 0    | 0  | 0  | 0  | 0   | 0  | 0  | 1  |
|              | Blue(002)        | 0  | 0  | 0  | 0   | 0  | 0  | 0  | 0     | 0  | 0  | 0  | 0   | 0  | 0  | 0  | 0    | 0  | 0  | 0  | 0   | 0  | 1  | 0  |
|              | :                | :  | :  | :  | :   | :  | :  | :  | :     | :  | :  | :  | :   | :  | :  | :  | :    | :  | :  | :  | :   | :  | :  | :  |
|              | Blue(253)        | 0  | 0  | 0  | 0   | 0  | 0  | 0  | 0     | 0  | 0  | 0  | 0   | 0  | 0  | 0  | 1    | 1  | 1  | 1  | 1   | 1  | 1  | 0  |
|              | Blue(254)        | 0  | 0  | 0  | 0   | 0  | 0  | 0  | 0     | 0  | 0  | 0  | 0   | 0  | 0  | 0  | 1    | 1  | 1  | 1  | 1   | 1  | 1  | 0  |
|              | Blue(255) bright | 0  | 0  | 0  | 0   | 0  | 0  | 0  | 0     | 0  | 0  | 0  | 0   | 0  | 0  | 0  | 1    | 1  | 1  | 1  | 1   | 1  | 1  | 1  |

c. Input signal timing  
Support Input Timing Table

|            | Item           | Description          | Min.  | Typ. | Max. | Unit           |
|------------|----------------|----------------------|-------|------|------|----------------|
| Clock      | Dclk           | period               | 14.63 | 22.5 | 40   | nS             |
|            |                | frequency            | 25    | 44.5 | 68.4 | MHz            |
| Vertical   | $T_{V\_TOTAL}$ | V total line number  | 905   | 926  | 942  | $T_{H\_TOTAL}$ |
|            | $T_{V\_DATA}$  | Data duration        | —     | 900  | —    | $T_{H\_TOTAL}$ |
|            | $T_{VB}$       | V-blank              | 5     | 26   | —    | $T_{H\_TOTAL}$ |
|            | $f_V$          | frequency            | 56    | 60   | 75   | Hz             |
| Horizontal | $T_{H\_TOTAL}$ | H total pixel number | 752   | 800  | 968  | DCIk           |
|            | $T_{H\_DATA}$  | Data duration        | —     | 720  | —    | DCIk           |
|            | $T_{HB}$       | H-blank              | 32    | 80   | —    | DCIk           |

Note: Because this module is operated by DE only mode, Hsync and Vsync input signals should be set to low Logic level or ground. Otherwise, this module would operate abnormally.

INPUT SIGNAL TIMING DIAGRAM

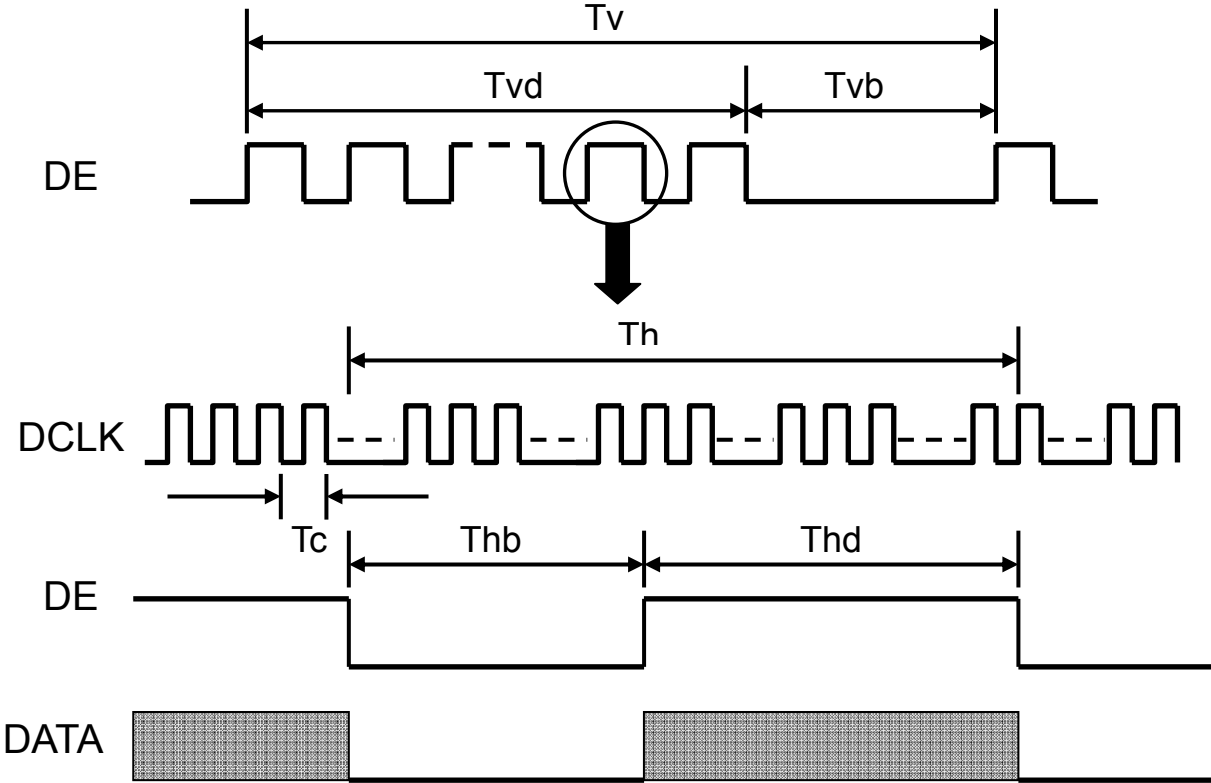

## d. Display Position

|           |           |       |             |       |              |              |
|-----------|-----------|-------|-------------|-------|--------------|--------------|
| D(1, 1)   | D(2, 1)   | ..... | D(720, 1)   | ..... | D(1439, 1)   | D(1440, 1)   |
| D(1, 2)   | D(2, 2)   | ..... | D(720, 2)   | ..... | D(1439, 2)   | D(1440, 2)   |
| ⋮         |           | ..... | ⋮           | ..... | ⋮            | ⋮            |
| D(1, 450) | D(2, 450) | ..... | D(720, 450) | ..... | D(1439, 450) | D(1440, 450) |
| ⋮         |           | ..... | ⋮           | ..... | ⋮            | ⋮            |
| D(1, 899) | D(2, 899) | ..... | D(720, 899) | ..... | D(1439, 899) | D(1440, 899) |
| D(1, 900) | D(2, 900) | ..... | D(720, 900) | ..... | D(1439, 900) | D(1440, 900) |

## e. Backlight driving conditions

| Parameter              | Symbol  | Min. | Typ.  | Max. | Unit  | Remark   | Remark       |
|------------------------|---------|------|-------|------|-------|----------|--------------|
| Lamp voltage           | VL      | 660  | 730   | 800  | Vrms  |          |              |
| Lamp operation current | IL      | 2    | 7.0   | 7.5  | mArms |          | Note 1       |
| Lamp starting voltage  | VLstart | 1450 | -     | -    | Vrms  | T = 25°C | Note 2,3,4,5 |
|                        |         | 1700 | -     | -    |       | T = 0°C  | Note 2,3,4,5 |
| Frequency              | F       | 40   | -     | 80   | KHZ   |          | Note 5       |
| Lamp life time         |         | -    | 50000 | -    | Hr    |          | Note 6       |

Note: The waveform of the voltage output of inverter must be area-symmetric and the design of the inverter must have specifications for the modularized lamp. The performance of the Backlight, such as lifetime or brightness, is greatly influenced by the characteristics of the DC-AC inverter for the lamp. All the parameters of an inverter should be carefully designed to avoid producing too much current leakage from high voltage output of the inverter. When designing or ordering the inverter please make sure that a poor lighting caused by the mismatch of the Backlight and the inverter (miss-lighting, flicker, etc.) never occurs. If the above situation is confirmed, the module should be operated in the same manners when it is installed in your instrument.

Note 1: The degree of unbalance: less than 10%

The ratio of wave height: less than  $\sqrt{2} \pm 10\%$

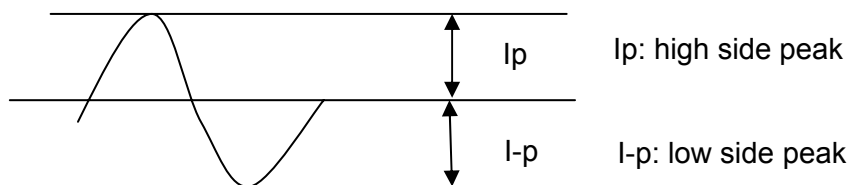

The degree of unbalance =  $|Ip - I-p| / Irms * 100(\%)$

The ratio of wave height =  $Ip \text{ (or } I-p) / Irms$

Lamp should be completely turned on.

Note 2: Test equipment: AS-114B

Note 3: The voltage shown above should be applied to the lamp for more than 1 second after startup. Otherwise, the lamp may not be turned on normally.

Note 4: Inverter should provide more than min. value, and then lamp could be completely turned on

Note 5: Lamp frequency may produce interference with horizontal synchronous frequency and this may cause line flow on the display. Therefore lamp frequency shall be detached from the horizontal synchronous frequency and its harmonics as far as possible in order to avoid interference.

Note 6: Life time (Hr) is defined as the time when brightness of a lamp unit itself becomes 50% or less than its original value at the condition of  $T_a = 25 \pm 2^\circ\text{C}$  and  $I_L = 7.0\text{mA}_{\text{rms}}$ .

Backlight connector: 3500IHS-02L

| Pin no. | Symbol | Function                | Remark             |
|---------|--------|-------------------------|--------------------|
| 1       | VIH    | Lamp high voltage input | Cable color: Pink  |
| 2       | VIL    | Lamp low voltage input  | Cable color: White |
| 3       | VIH    | Lamp high voltage input | Cable color: Blue  |
| 4       | VIL    | Lamp low voltage input  | Cable color: Black |

**C. Optical specifications**

| Item                    | Symbol     | Condition          | Specification |       |       | Unit | Remark     |
|-------------------------|------------|--------------------|---------------|-------|-------|------|------------|
|                         |            |                    | Min.          | Typ.  | Max.  |      |            |
| Response time           | Tr         | $\theta = 0^\circ$ | -             | 1.5   | 4     | ms   | Note 4     |
|                         | Tf         |                    | -             | 3.5   | 6     |      |            |
|                         | Tr+Tf      |                    | -             | 5     | 10    |      |            |
| Contrast ratio          | CR         | $\theta = 0^\circ$ | 700           | 1000  | -     |      | Note 3,5   |
| Viewing angle           | Top        | $CR \geq 10$       | 70            | 80    | -     | deg. | Note 3,5,7 |
|                         |            | $CR \geq 5$        | 75            | 85    |       |      |            |
|                         | Bottom     | $CR \geq 10$       | 70            | 80    | -     |      |            |
|                         |            | $CR \geq 5$        | 75            | 85    |       |      |            |
|                         | Left       | $CR \geq 10$       | 70            | 80    | -     |      |            |
|                         |            | $CR \geq 5$        | 75            | 85    |       |      |            |
|                         | Right      | $CR \geq 10$       | 70            | 80    | -     |      |            |
|                         |            | $CR \geq 5$        | 75            | 85    |       |      |            |
| Brightness (Center)     | $Y_L$      |                    | 250           | 300   | -     | nit  | Note 3,6   |
| Color chromaticity(CIE) | $W_x$      | $\theta = 0^\circ$ | -0.03         | 0.313 | +0.03 |      | Note 3     |
|                         | $W_y$      |                    |               | 0.329 |       |      |            |
|                         | $R_x$      |                    |               | 0.640 |       |      |            |
|                         | $R_y$      |                    |               | 0.349 |       |      |            |
|                         | $G_x$      |                    |               | 0.284 |       |      |            |
|                         | $G_y$      |                    |               | 0.617 |       |      |            |
|                         | $B_x$      |                    |               | 0.142 |       |      |            |
|                         | $B_y$      |                    |               | 0.067 |       |      |            |
| White uniformity (9)    | $\delta_w$ |                    | 0.75          | 0.80  | -     |      | Note 3,8   |
| Cross talk              | Ct         |                    | -             | -     | 2%    |      | Note 9     |

Note 1: Ambient temperature = 25°C.

Note 2: To be measured in dark room after backlight warm up 30 minutes.

Note 3: To be measured with a viewing cone of 2° by Topcon luminance meter BM-5A.

Note 4: Definition of response time:

The output signals of BM-7 are measured when the input signals are changed from “Black” to “White” (falling time) and from “White” to “Black” (rising time), respectively. The response time interval is between the 10% and 90% of amplitudes. Refer to figure as below.

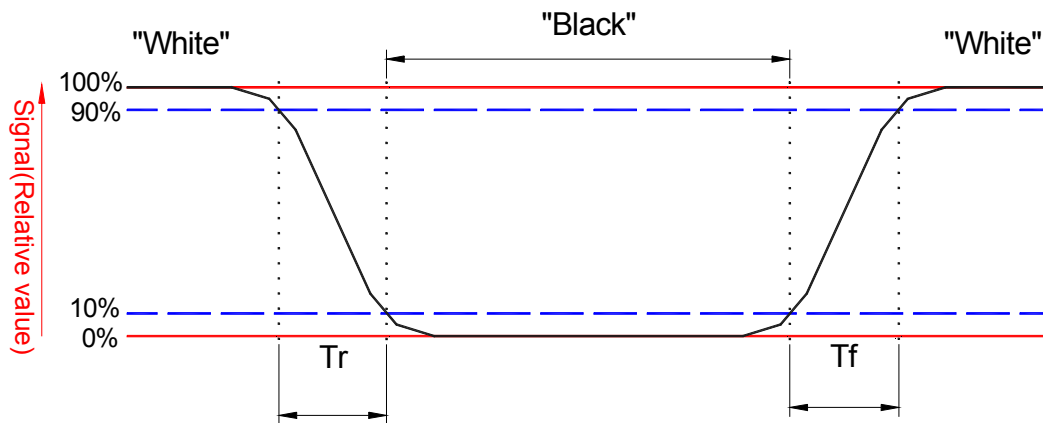

Note 5: Definition of contrast ratio:

Contrast ratio is calculated by the following formula.

$$\text{Contrast ratio (CR)} = \frac{\text{Brightness on the "white" state}}{\text{Brightness on the "black" state}}$$

Note 6: Driving conditions for CCFL:  $I_L = 7 \text{ mA}$ , 50 KHz Frequency.

Note 7: Definition of viewing angle

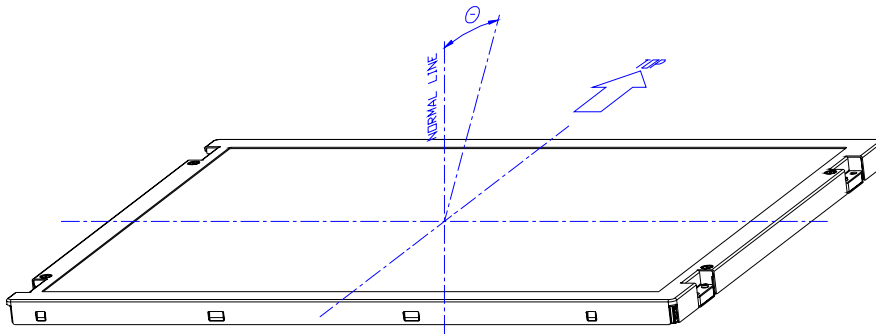

Note 8: Definition white uniformity:

Luminance are measured at the following nine points (P1~P9).

$$\delta_w = \frac{\text{Minimum Brightness of nine points (P1~P9)}}{\text{Maximum Brightness of nine points (P1~P9)}}$$



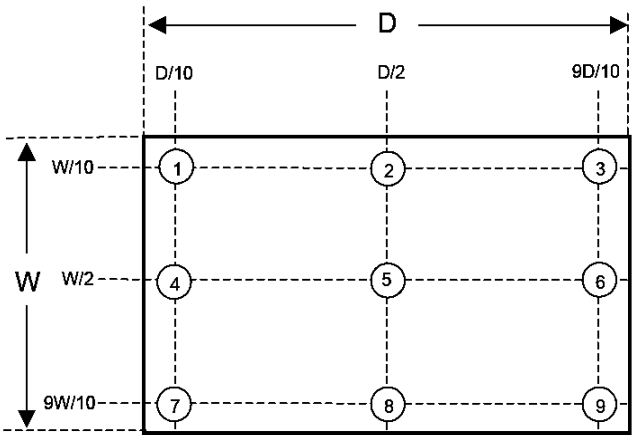

Note 9:

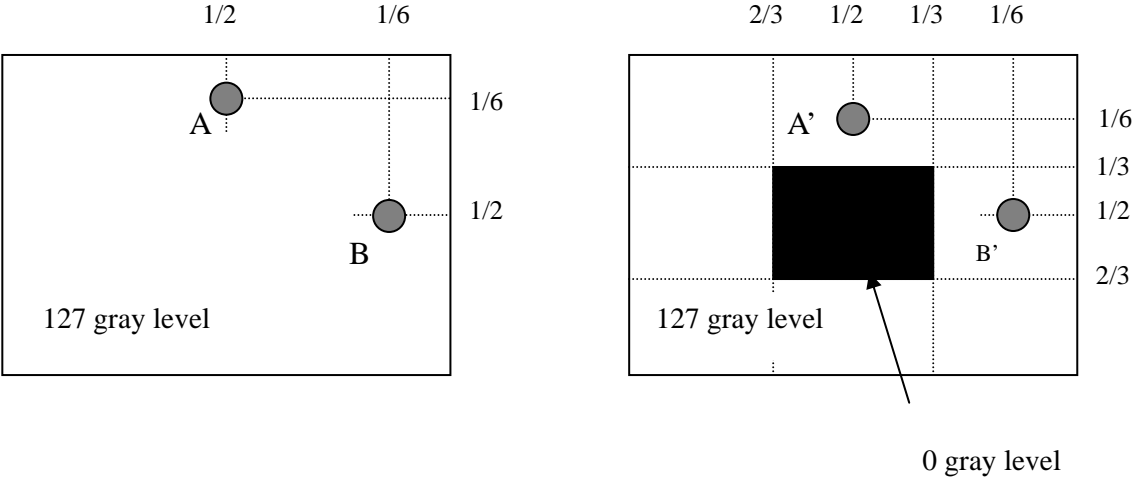

$|L_A - L_{A'}| / L_A \times 100\% = 2\% \text{ max.}$ ,  $L_A$  and  $L_{A'}$  are brightness at location A and A'  
 $|L_B - L_{B'}| / L_B \times 100\% = 2\% \text{ max.}$ ,  $L_B$  and  $L_{B'}$  are brightness at location B and B'

Note 10: Optical characteristic measurement setup.

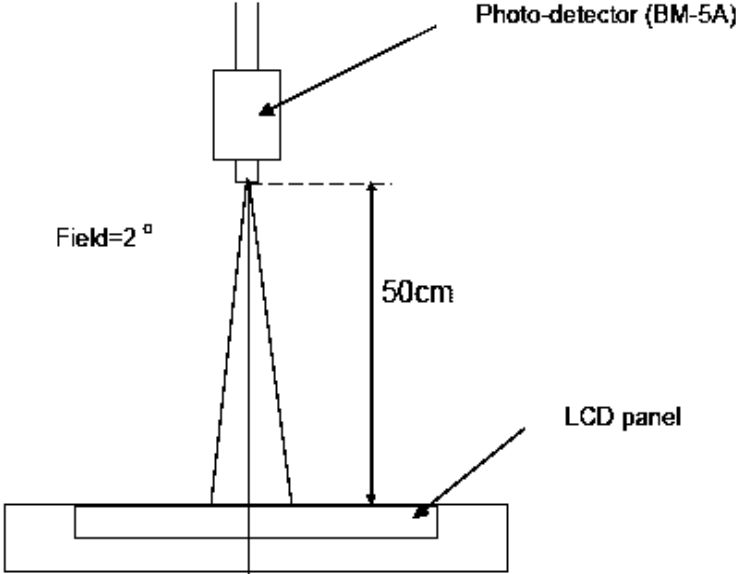

**D. Reliability test items**

| Test Item  | Test Condition   | Judgment | Remark |
|--|--|----------|--------|
| High temperature storage                         | 60°C, 240Hrs   | Note 1   | Note 2 |
| Low temperature storage                          | -25°C, 240Hrs  | Note 1   | Note 2 |
| High temperature & high humidity operation       | 40°C, 90%RH, 240Hrs<br>(No condensation)   | Note 1   | Note 2 |
| High temperature operation                       | 50°C, 240Hrs   | Note 1   | Note 2 |
| Low temperature operation                        | 0°C, 240Hrs  | Note 1   | Note 2 |
| Thermal Shock<br>(non-operation)                 | -20°C~60°C<br>1Hr, 10mins, 1Hr, 100cycles  | Note 1   | Note 2 |
| Electrostatic discharge (ESD)<br>(non-operation) | Contact: +/-8kV, 150pF(330ohms),<br>25 times/1 point, 1 time/1 sec<br>Air discharge: +/-15kV, 150pF(330ohms), 25<br>times/1 point, 1 time/1 sec          | Note 1   | Note 2 |
| Vibration<br>(non-operation)                     | Vibration level : 1.5G<br>Bandwidth : 10-300Hz<br>Waveform : sine wave,<br>sweep rate : 10min<br>30 min for each direction X, Y, Z<br>(1.5 Hrs in total) | Note 1   | Note 2 |
| Mechanical Shock<br>(non-operation)              | Shock level : 50G, 11ms<br>Waveform : Half sine wave<br>Direction : ±X, ±Y, ±Z<br>One time each direction  | Note 1   | Note 2 |
| MTBF Demonstration                               | 50,000 hours (Typ.) with confidence level 90%  | Note 1   | Note 3 |

Note1: Pass: Normal display image with no obvious non-uniformity and no line defect.

Partial transformation of the module parts should be ignored.

Fail: No display image, obvious non-uniformity, or line defects.

Note2: Evaluation should be tested after storage at room temperature for one hour.

Note 3: The MTBF calculation is based on the assumption that the failure rate distribution meets the Exponential Model (CCFL excluded)

**E. Safety****(1) Sharp Edge Requirements**

There will be no sharp edges or corners on the display assembly that could cause injury.

**(2) Materials****a. Toxicity**

There will be no carcinogenic materials used anywhere in the display module. If toxic materials are used, they will be reviewed and approved by the responsible InnoLux Toxicologist.

**b. Flammability**

All components including electrical components that do not meet the flammability grade UL94-V1 in the module will complete the flammability rating exception approval process. The printed circuit board will be made from material rated 94-V1 or better. The actual UL flammability rating will be printed on the printed circuit board.

**c. Capacitors**

If any polarized capacitors are used in the display assembly, provisions will be made to keep them from being inserted backwards.

**F. Display quality**

The display quality of the color TFT-LCD module should be in compliance with the Innolux's Incoming inspection standard.

**G. Handling precaution**

The Handling of the TFT-LCD should be in compliance with the Innolux's handling principle standard.

H. Label

(1) Module Label

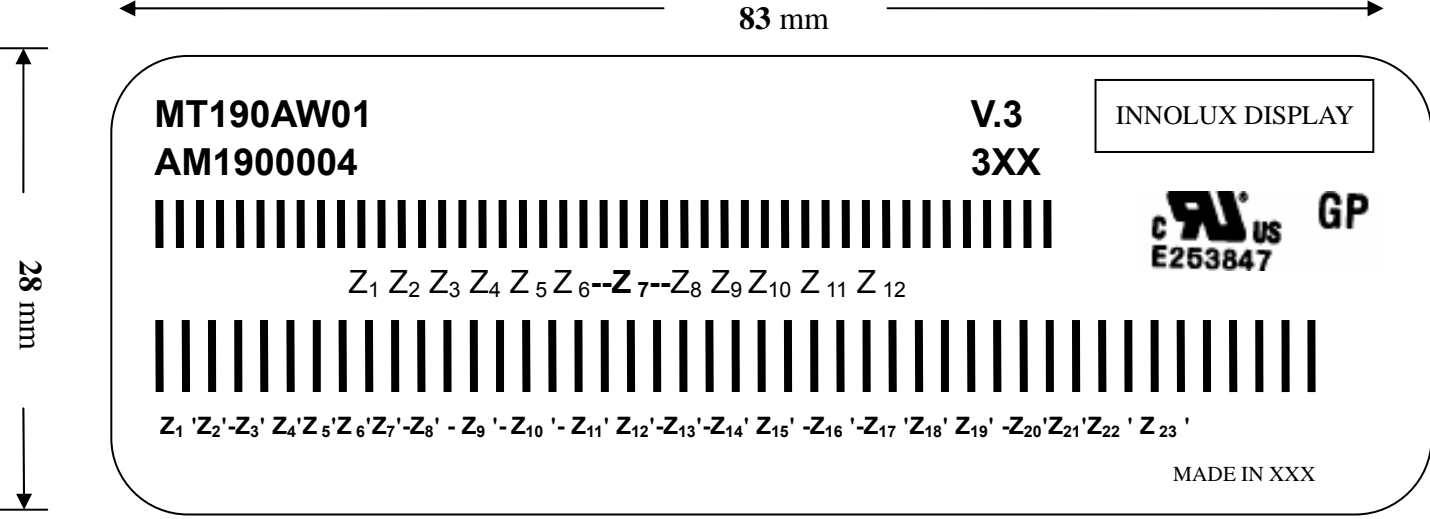

(a) Model Number: MT190AW01

(b) Version: V.3

(c) Serial ID I:  $Z_1 Z_2 Z_3 Z_4 Z_5 Z_6 Z_7 Z_8 Z_9 Z_{10} Z_{11} Z_{12}$

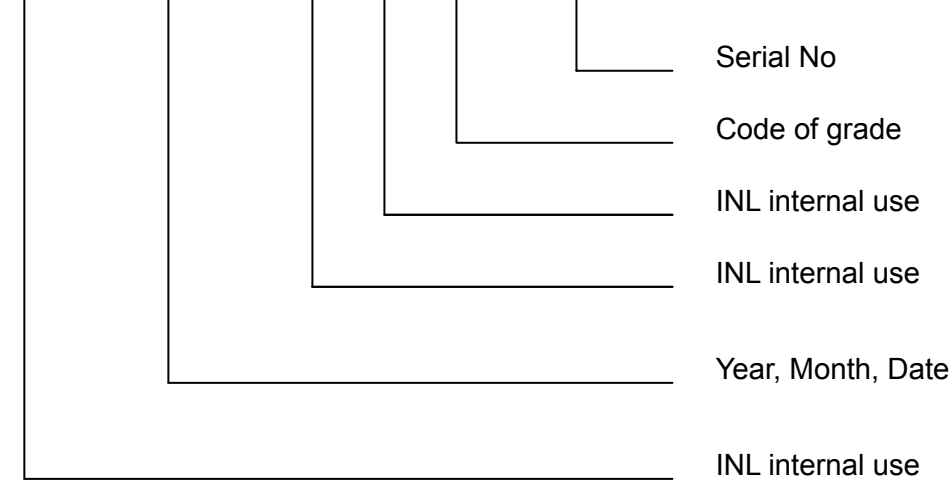

Serial ID includes the information as below:

1. Manufactured Date: Year: 0~9, for 2000~2009
2. Month: 1~9 & A~C for Jan.~Dec.
3. Date: 1~9 & A~Z (exclude I, O, Q, U) for 1st~31th
4. Code of grade: 1, 2, 3, 5, E
5. Serial No: Module manufacture sequence no

(d) Serial ID II (INL internal use)

(2) Carton Label

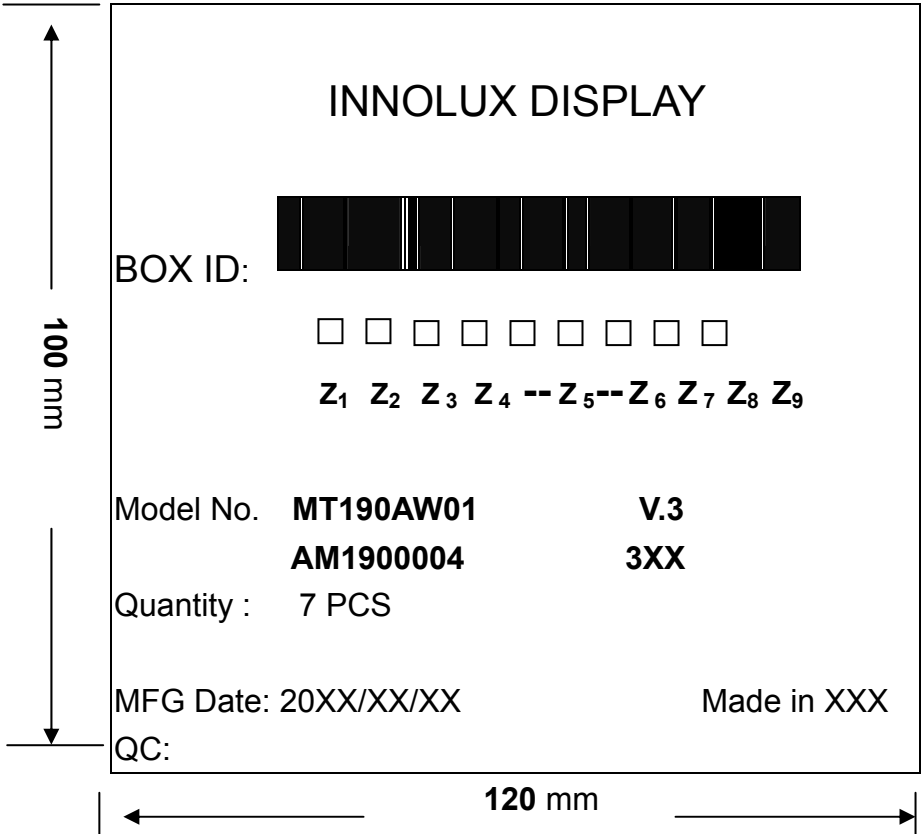

(a) Model Number: MT190AW01

(b) Version: V.3

(c) Packing quantity: 7 pcs

(d) Serial ID: Z<sub>1</sub> Z<sub>2</sub> Z<sub>3</sub> Z<sub>4</sub> Z<sub>5</sub> Z<sub>6</sub> Z<sub>7</sub> Z<sub>8</sub> Z<sub>9</sub>

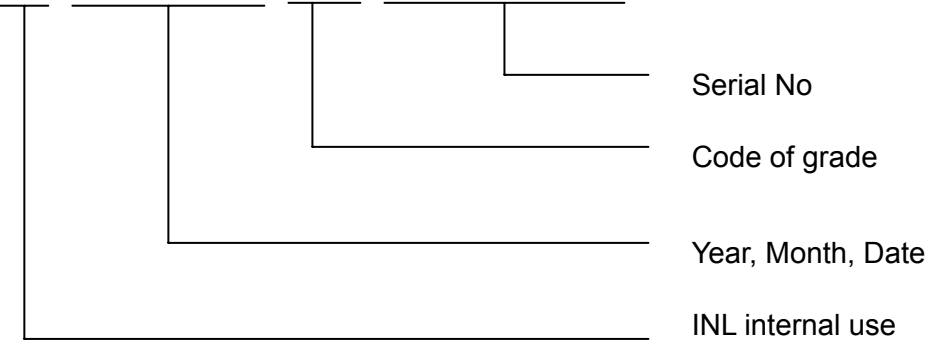

Serial ID includes the information as below:

(a) Manufactured Date: Year: 0~9, for 2000~2009

Month: 1~9 & A~C for Jan.~Dec.

Date: 1~9 & A~Z (exclude I, O, Q, U) for 1st~31th

(b) Code of grade: 1,2, 3, 5, E

(c) Serial No: Module packing sequence no

# I. ME Drawing

## (1) Front view

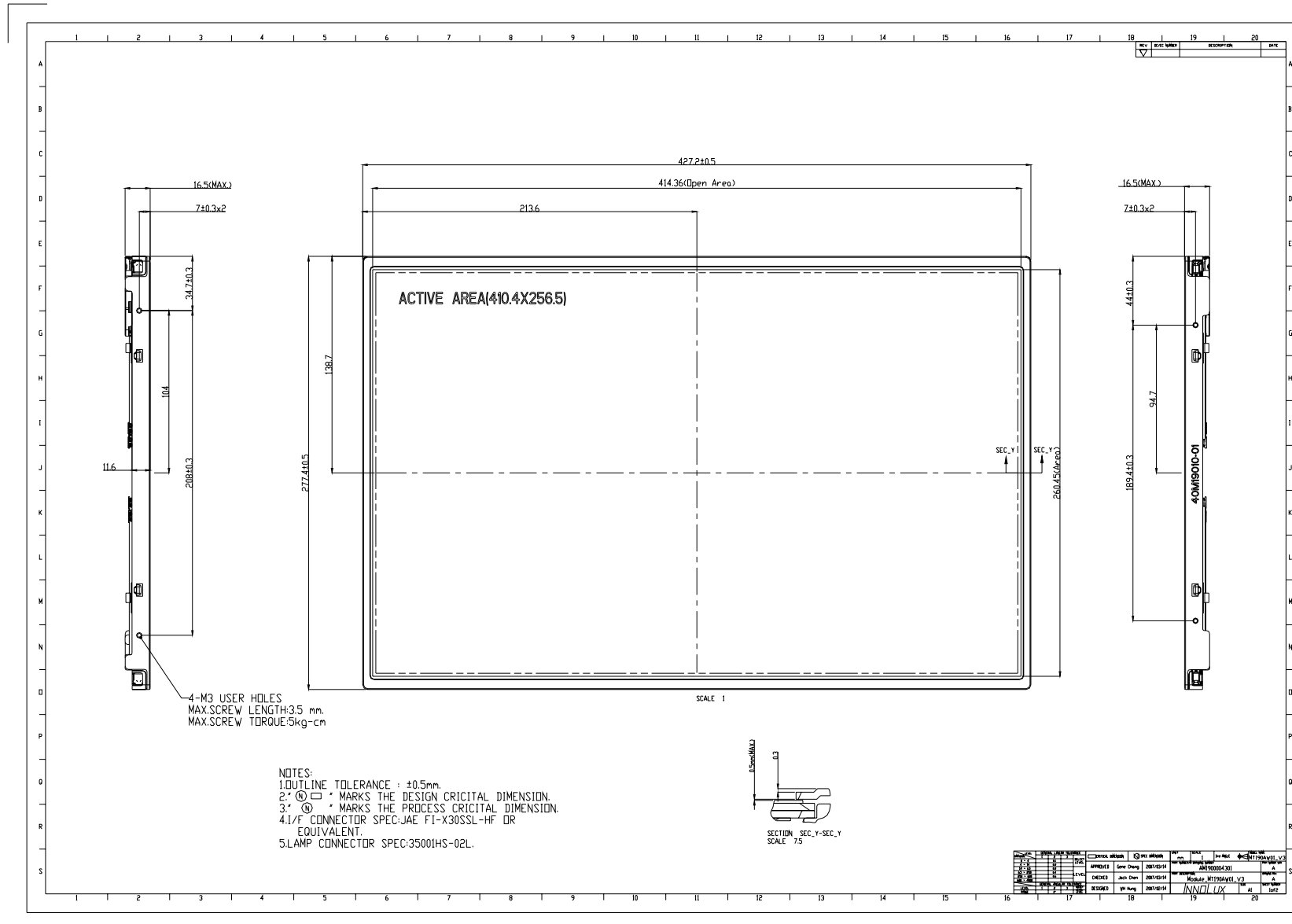

## (2) Back view

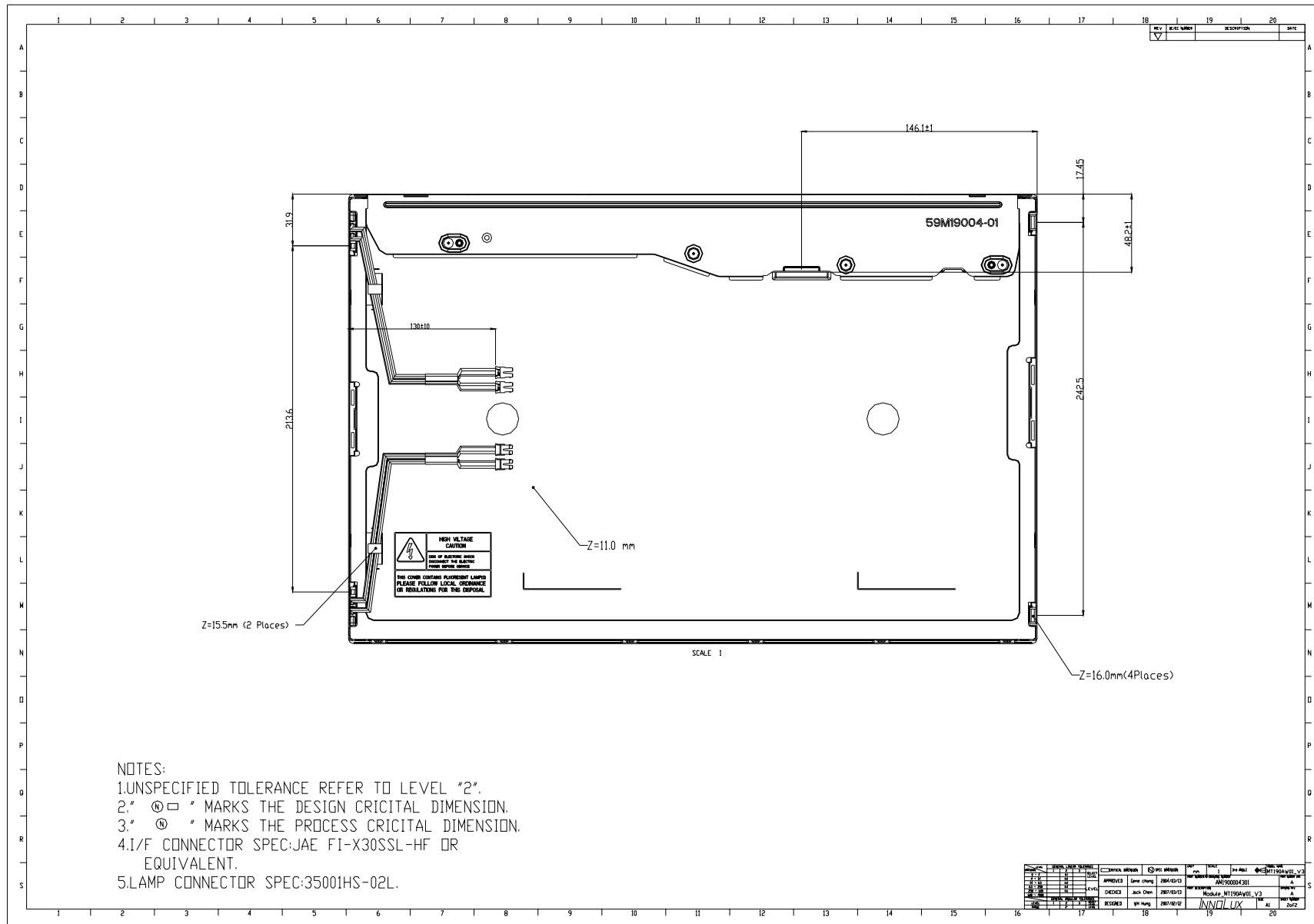

### NOTES:

1. UNSPECIFIED TOLERANCE REFER TO LEVEL "2".
2. "Ⓢ" MARKS THE DESIGN CRITICAL DIMENSION.
3. "Ⓢ" MARKS THE PROCESS CRITICAL DIMENSION.
4. I/F CONNECTOR SPEC: JAE FI-X30SSL-HF OR EQUIVALENT.
5. LAMP CONNECTOR SPEC: 35001HS-02L.

<http://www.BDTIC.com/Innolux>

<http://www.BDTIC.com/INNOLUX>