

### Features

- Surface Mount Device
- No Wire Bonding Required
- Rugged Silicon-Glass Construction
- Silicon Nitride Passivation
- Polymer Scratch Protection
- Low Parasitic Capacitance and Inductance
- Higher Average and Peak Power Handling
- RoHS\* Compliant and 260°C Reflow Compatible

### Description and Applications

This device is a silicon-glass PIN diode chip fabricated with M/A-COM Technology Solutions patented HMIC™ process. This device features two silicon pedestals embedded in a low loss glass. The diode is formed on the top of one pedestal and connections to the backside of the device are facilitated by making the pedestal sidewalls conductive. Selective backside metalization is applied producing a surface mount device. The topside is fully encapsulated with silicon nitride and has an additional polymer layer for scratch protection. These protective coatings prevent damage to the junction and the anode air-bridge during handling and assembly.

These packageless devices are suitable for usage in moderate incident power (10 W C.W.) or higher incident peak power (500 W) series, shunt, or series-shunt switches. Small parasitic inductance, 0.35 nH, and an excellent RC time constant, 0.22 pS, make these devices ideal for switch applications where higher  $P_{1dB}$  and IP3 values are required. These diodes can also be used in p, T, tapered resistance, and switched-pad attenuator control circuits for 50W or 75W systems.

Ordering Information	
Gel Pack (100 pieces)	Tape and Reel Pocket Tape (3000 pieces)
MA4SPS502	MADP-000502-12700P

### Case Style Outline Drawing ODS-1270<sup>1,2</sup>

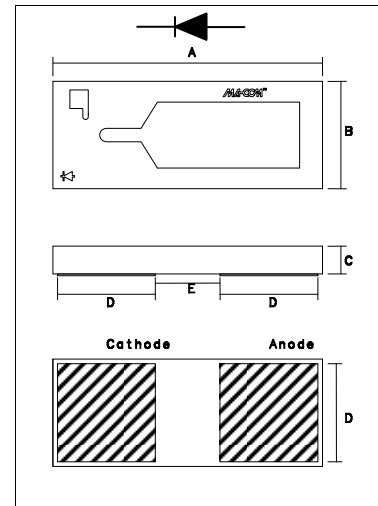

1. Backside metal: 0.1 μm thick.
2. Hatched areas indicate backside ohmic gold contacts.

DIM	INCHES		MM	
	Min.	Max.	Min.	Max.
A	0.058	0.062	1.47	1.57
B	0.026	0.030	0.66	0.76
C	0.004	0.006	0.10	0.15
D	0.020	0.022	0.51	0.56
E	0.013	0.015	0.33	0.38

### Absolute Maximum Ratings @ T<sub>AMB</sub> = 25°C

Parameter	Absolute Maximum
Forward Current	600mA
Reverse Voltage	-275 V
Operating Temperature	-65°C to +125°C
Storage Temperature	-55 °C to +150°C
Junction Temperature	+175°C
Dissipated Power (RF & DC)	3W

\* Restrictions on Hazardous Substances, European Union Directive 2002/95/EC.

**ADVANCED:** Data Sheets contain information regarding a product M/A-COM Technology Solutions is considering for development. Performance is based on target specifications, simulated results, and/or prototype measurements. Commitment to develop is not guaranteed.  
**PRELIMINARY:** Data Sheets contain information regarding a product M/A-COM Technology Solutions has under development. Performance is based on engineering tests. Specifications are typical. Mechanical outline has been fixed. Engineering samples and/or test data may be available. Commitment to produce in volume is not guaranteed.

• **North America** Tel: 800.366.2266 • **Europe** Tel: +353.21.244.6400  
 • **India** Tel: +91.80.43537383 • **China** Tel: +86.21.2407.1588  
 Visit [www.macontech.com](http://www.macontech.com) for additional data sheets and product information.

M/A-COM Technology Solutions Inc. and its affiliates reserve the right to make changes to the product(s) or information contained herein without notice.

## Electrical Specifications @ T<sub>AMB</sub> = +25°C

Symbol	Conditions	Units	Min.	Typical	Max.
C <sub>T</sub>	-40V, 1MHz	pF		0.140	0.200
	-40V, 1GHz	pF		0.090	
R <sub>S</sub>	100mA, 100MHz	Ω		1.4	2.2
	20mA, 100MHz	Ω		2.4	3.2
V <sub>F</sub>	10mA	V		0.87	1.00
V <sub>R</sub>	10μA	V	-200	-275	
I <sub>R</sub>	-200V	μA			-10
	-40V	nA		8	
θ <sub>JL</sub>	Steady State	°C/W		50	
T <sub>L</sub>	+10mA / -6mA ( 50% - 90% V )	μS		2.8	

### Handling

All semiconductor chips should be handled with care to avoid damage or contamination from perspiration and skin oils. The use of plastic tipped tweezers or vacuum pickups is strongly recommended for individual components. Bulk handling should ensure that abrasion and mechanical shock are minimized.

### Die Attach

Attachment to a circuit board is made simple through the use of surface mount technology. Mounting pads are conveniently located on the bottom surface of these devices and are removed from the active junction locations. These devices are well suited for solder attachment onto hard and soft substrates. The use of 80/20, Au/Sn or RoHS compliant solders is recommended. A conductive silver epoxy may also be used.

When soldering these devices to a hard substrate, hot gas die bonding is preferred. We recommend utilizing a vacuum tip and force of 60 to 100 grams applied to the top surface of the device. When soldering to soft substrates, it is recommended to use a Gold-Tin interface at the circuit board mounting pads. Position the device so that its mounting pads are force aligned with the circuit board mounting pads and reflow the solder by heating the circuit trace near the mounting pads while applying 60 to 100 grams of perpendicular to the top surface of the die.

The solder joint must **not** be made one pad at a time. Doing so could create unequal heat flow and produce thermal and/or mechanical stresses. It is also **not** recommended to reflow solder by causing heat to flow through the top surface of the die. Since the HMIC glass is transparent, the edges of the mounting pads can be visually inspected through the die after attach is completed.

**Typical Total Resistance ( $R_s$ ) vs. Forward Current ( $I_f$ ) and Frequency**

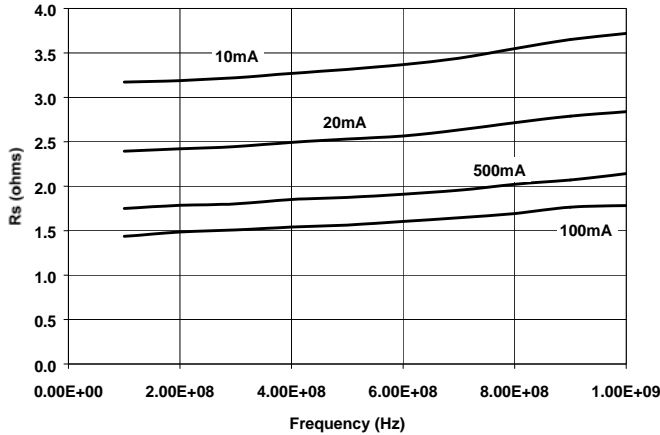

**Typical Total Capacitance ( $C_T$ ) vs. Reverse ( $V_r$ ) Voltage and Frequency**

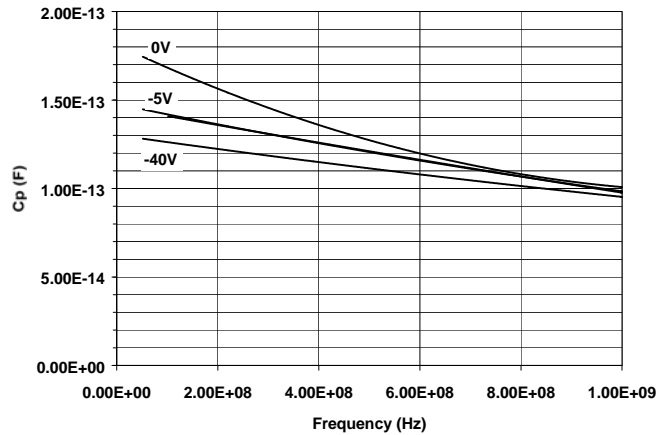

**$C_T$  vs.  $V_r$  @ 100MHz and 1GHz**

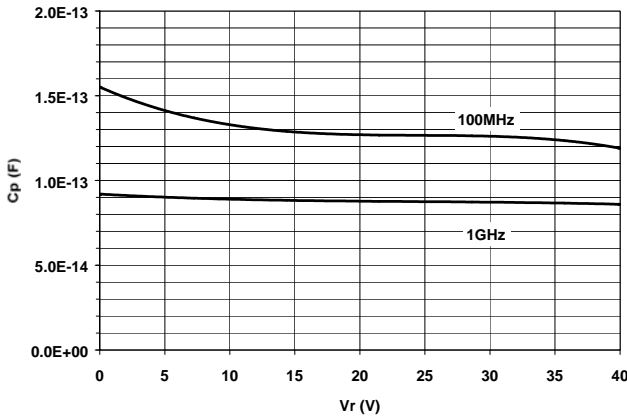

**Parallel Resistance ( $R_p$ ) vs.  $V_r$  @ 100MHz**

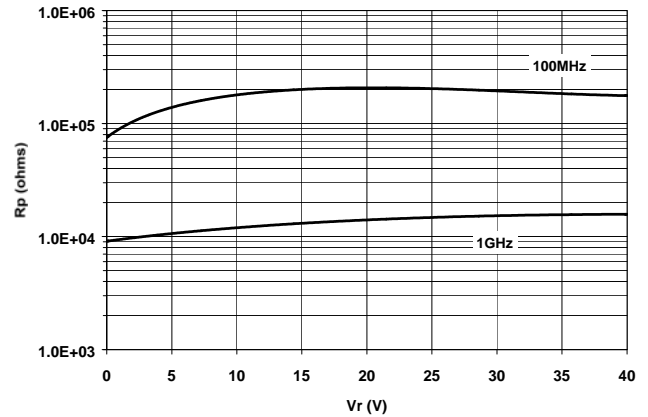

**$R_s$  vs.  $I_f$  @ 100MHz and 1GHz**

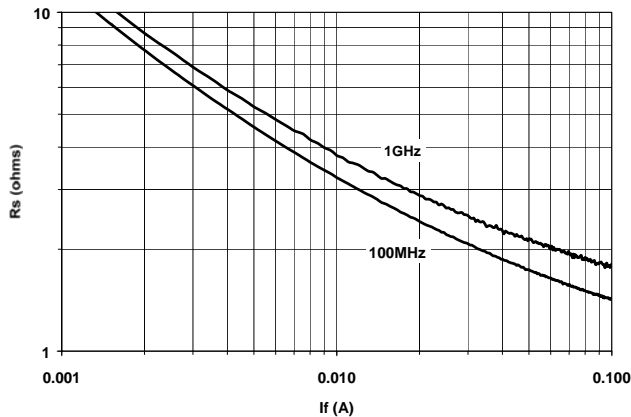

**Series Inductance ( $L_s$ ) vs. Frequency @ 10mA**

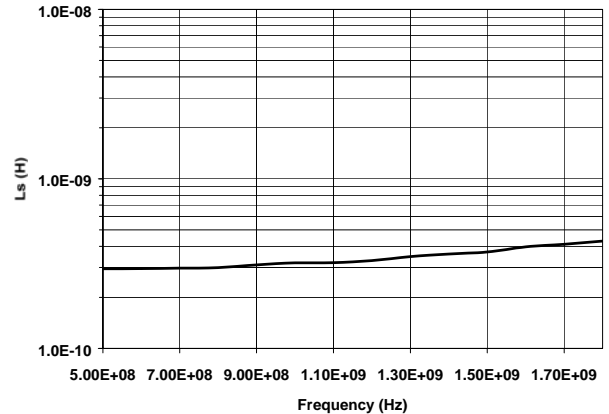

**ADVANCED:** Data Sheets contain information regarding a product M/A-COM Technology Solutions is considering for development. Performance is based on target specifications, simulated results, and/or prototype measurements. Commitment to develop is not guaranteed.  
**PRELIMINARY:** Data Sheets contain information regarding a product M/A-COM Technology Solutions has under development. Performance is based on engineering tests. Specifications are typical. Mechanical outline has been fixed. Engineering samples and/or test data may be available. Commitment to produce in volume is not guaranteed.

• **North America** Tel: 800.366.2266 • **Europe** Tel: +353.21.244.6400  
 • **India** Tel: +91.80.43537383 • **China** Tel: +86.21.2407.1588  
 Visit [www.macontech.com](http://www.macontech.com) for additional data sheets and product information.

M/A-COM Technology Solutions Inc. and its affiliates reserve the right to make changes to the product(s) or information contained herein without notice.

## MA4SPS502 ADS SPICE Model & Schematic

### MA4SPS502 SPICE Model

PinDiodeModel	wBv=200 V
NLPINM1	wPmax=2.0 W
Is=1.0E-14 A	Ffe=1.0
Vi=0.0 V	
Un=900 cm <sup>2</sup> /V-sec	
Wi=40 um	
Rr=20 K Ohm	
Cmin=0.12 pF	
Tau=2.8 usec	
Rs=0.1 Ohm	
Cj0=0.18 pF	
Vj=0.7 V	
M=0.5	
Fc=0.5	
Imax=2.5E+7 A/m <sup>2</sup>	
Kf=0.0	
Af=1.0	

### MA4SPS502 Lumped Element Model

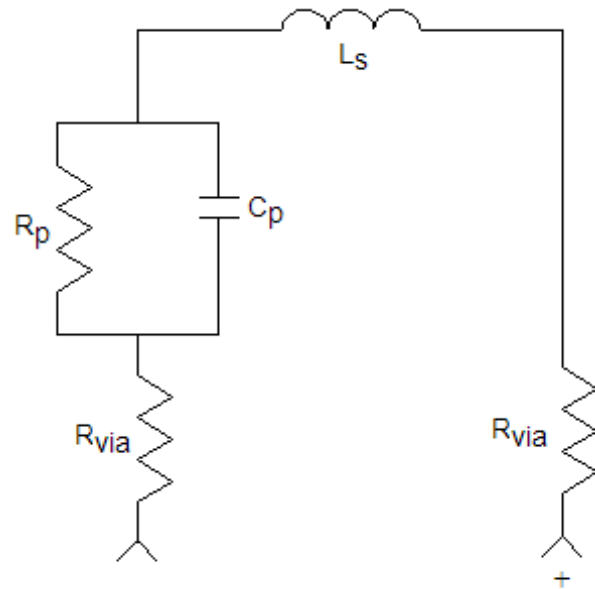

Note:  $R_S = 2 * R_{via} + R_p$