

## Features

- Integrated Logic
- Positive Single Control
- Insertion Loss: 2.0 dB @ 3.4 GHz
- IP3: >42 dBm typical @ 2.0 GHz
- Attenuation Accuracy: 0.3 dB + 3% @ 3.4 GHz
- 0.5 dB Attenuation Steps to 15.5 dB
- Lead-Free 3 mm 16-Lead PQFN Package
- Halogen-Free "Green" Mold Compound
- RoHS\* Compliant and 260°C Re-flow Compatible

## Description

M/A-COM's MAADSS0018 is a 5-bit, 0.5-dB step GaAs MMIC digital attenuator in a lead-free 3mm 16 lead PQFN surface mount plastic package. The MAADSS0018 is ideally suited for use where high accuracy, very low power consumption and low intermodulation products are required. Typical applications include radio, cellular, wireless LANs, GPS equipment and other gain / level control circuits.

The MAADSS0018 is part of a digital attenuator family. This family includes 4, 5 and 6 bit attenuators with 0.5, 1 or 2 dB steps and up to 31.5 range.

## Ordering Information <sup>1,2</sup>

Part Number	Package
MAADSS0018TR-1000	1000 piece reel
MAADSS0018TR-3000	3000 piece reel
MAADSS0018SMB	Sample Board

1. Reference Application Note M513 for reel size information.
2. All sample boards include 5 loose parts.

## Functional Schematic <sup>3</sup>

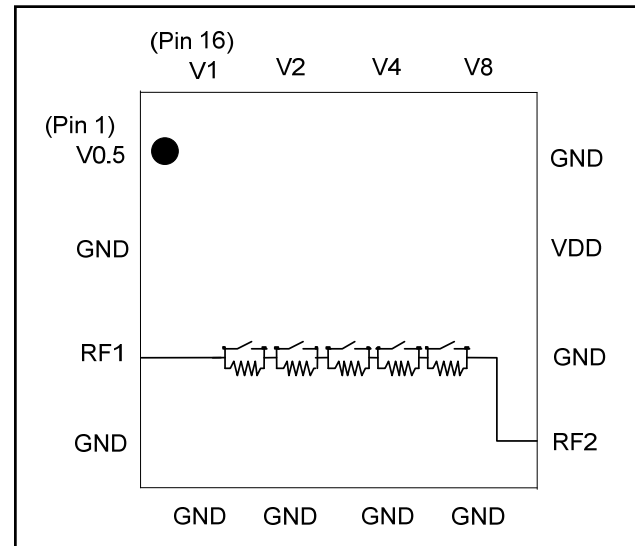

3. Blocking capacitors are required on all RF ports

## Pin Configuration

Pin No.	Function	Pin No.	Function
1	V0.5 (0.5dB Bit)	9	RF In/Out
2	Ground	10	Ground
3	RF In/Out	11	VDD
4	Ground	12	Ground
5	Ground	13	V8 (8dB Bit)
6	Ground	14	V4 (4dB Bit)
7	Ground	15	V2 (2dB Bit)
8	Ground	16	V1 (1dB Bit)

\* Restrictions on Hazardous Substances, European Union Directive 2002/95/EC.

## Digital Attenuator, 5-Bit, Single Control 15.5 dB, 2.0 - 6.0 GHz

Rev. V1

### Electrical Specifications <sup>4</sup>: $T_A = 25^\circ\text{C}$ , $Z_0 = 50\ \Omega$ , $V_{DD} = 5\ \text{V}$ , $V_C = 5\ \text{V}$

Parameter	Test Conditions	Units	Min.	Typ.	Max.
Reference Insertion Loss	3.4 GHz	dB	0.0	2.0	3.0
Attenuation Accuracy	3.4 GHz	$\pm (0.3\ \text{dB} + 3\% \text{ of attenuation setting in dB})\ \text{dB}$			
VSWR	2.0 - 6.0 GHz	Ratio	—	1.45:1	—
Trise, Tfall	10% to 90% RF, 90% to 10% RF	ns	—	50	—
Ton, Toff	50% Control to 90% RF, 50% Control to 10% RF	ns	—	50	—
Transients	In Band	mV	—	75	—
Input P1dB	2.0 GHz	dBm	—	25	—
IP <sub>2</sub>	2-Tone, +5 dBm/tone, 1 MHz Spacing 2.0 - 6.0 GHz	dBm	—	80	—
IP <sub>3</sub>	2-Tone, +5 dBm/tone, 1 MHz Spacing 2.0 - 6.0 GHz	dBm	—	42	—
I <sub>C</sub>	$V_C = 5\ \text{V}$	$\mu\text{A}$	—	15	25
I <sub>DD</sub>	$V_{DD} = 5\ \text{V}$	$\mu\text{A}$	—	225	300

4. External DC blocking capacitors are required on all RF ports.

### Truth Table <sup>5</sup>

VC0.5	VC1	VC2	VC4	VC8	Attenuation (dB)
0	0	0	0	0	Reference IL
1	0	0	0	0	0.5
0	1	0	0	0	1
0	0	1	0	0	2
0	0	0	1	0	4
0	0	0	0	1	8
1	1	1	1	1	15.5

5. 0 = 0 V, 1 = 2.8 to 5V

### Absolute Maximum Ratings <sup>6,7</sup>

Parameter	Absolute Maximum
Input Power 2.0 - 6.0 GHz	+33 dBm
Control Voltage	$-0.5\ \text{V} \leq V_C \leq 5.5\ \text{V}$
Operating Temperature	$-40^\circ\text{C}$ to $+85^\circ\text{C}$
Storage Temperature	$-65^\circ\text{C}$ to $+150^\circ\text{C}$

6. Exceeding any one or combination of these limits may cause permanent damage to this device.

7. M/A-COM does not recommend sustained operation near these survivability limits.

## Typical Performance Curves

**Insertion Loss**

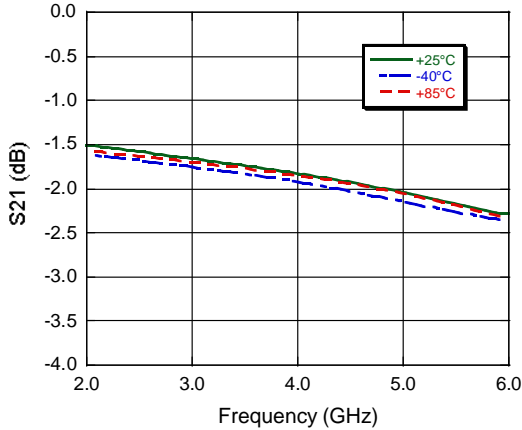

**Relative Attenuation across all major states**

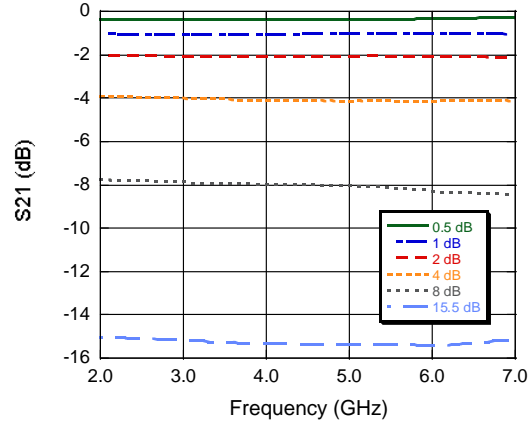

**Return Loss, Insertion Loss State**

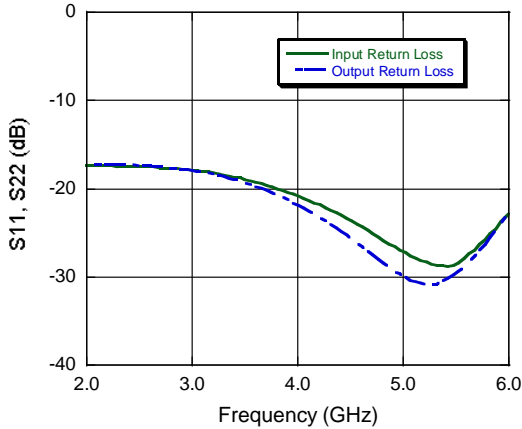

**Input Return Loss, across all major attenuation states**

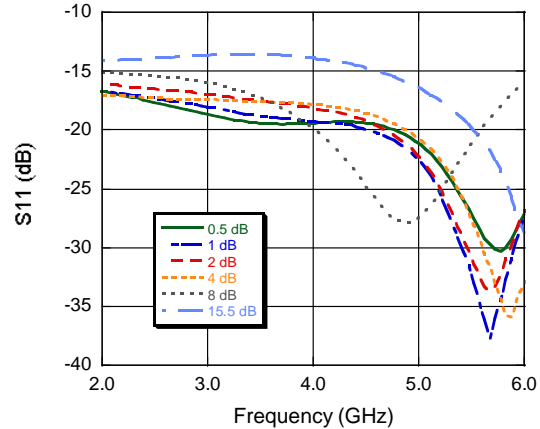

**Step Error vs. State over Frequency**

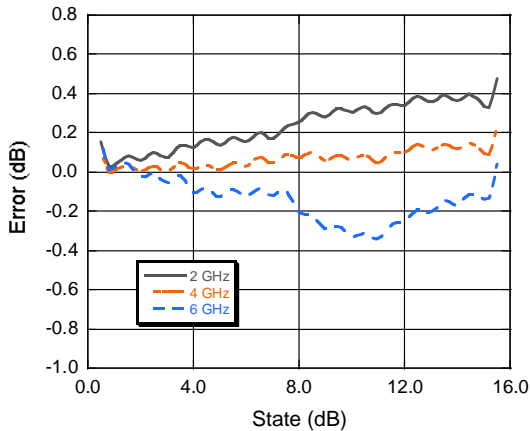

**Output Return Loss, across all major attenuation states**

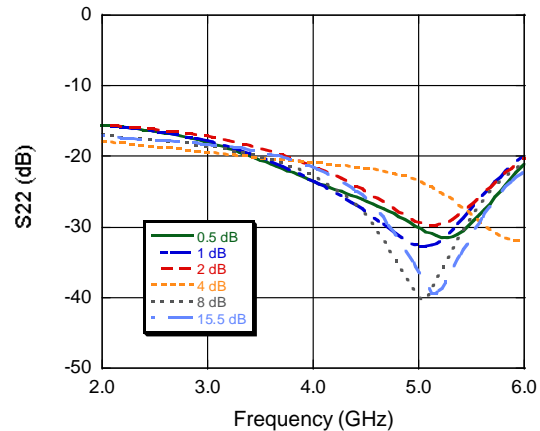

**ADVANCED:** Data Sheets contain information regarding a product M/A-COM Technology Solutions is considering for development. Performance is based on target specifications, simulated results, and/or prototype measurements. Commitment to develop is not guaranteed.  
**PRELIMINARY:** Data Sheets contain information regarding a product M/A-COM Technology Solutions has under development. Performance is based on engineering tests. Specifications are typical. Mechanical outline has been fixed. Engineering samples and/or test data may be available. Commitment to produce in volume is not guaranteed.

- **North America** Tel: 800.366.2266 / Fax: 978.366.2266
- **Europe** Tel: 44.1908.574.200 / Fax: 44.1908.574.300
- **Asia/Pacific** Tel: 81.44.844.8296 / Fax: 81.44.844.8298

Visit [www.macomtech.com](http://www.macomtech.com) for additional data sheets and product information.

M/A-COM Technology Solutions Inc. and its affiliates reserve the right to make changes to the product(s) or information contained herein without notice.

### IP3

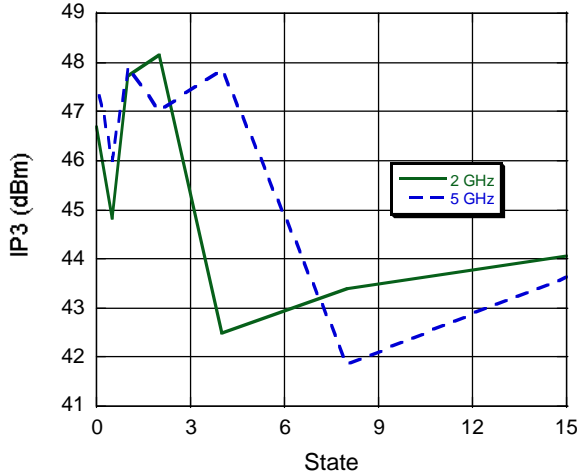

### Handling Procedures

Please observe the following precautions to avoid damage:

### Static Sensitivity

Gallium Arsenide Integrated Circuits are sensitive to electrostatic discharge (ESD) and can be damaged by static electricity. Proper ESD control techniques should be used when handling these devices.

### Lead Free 3 mm 16-Lead PQFN †

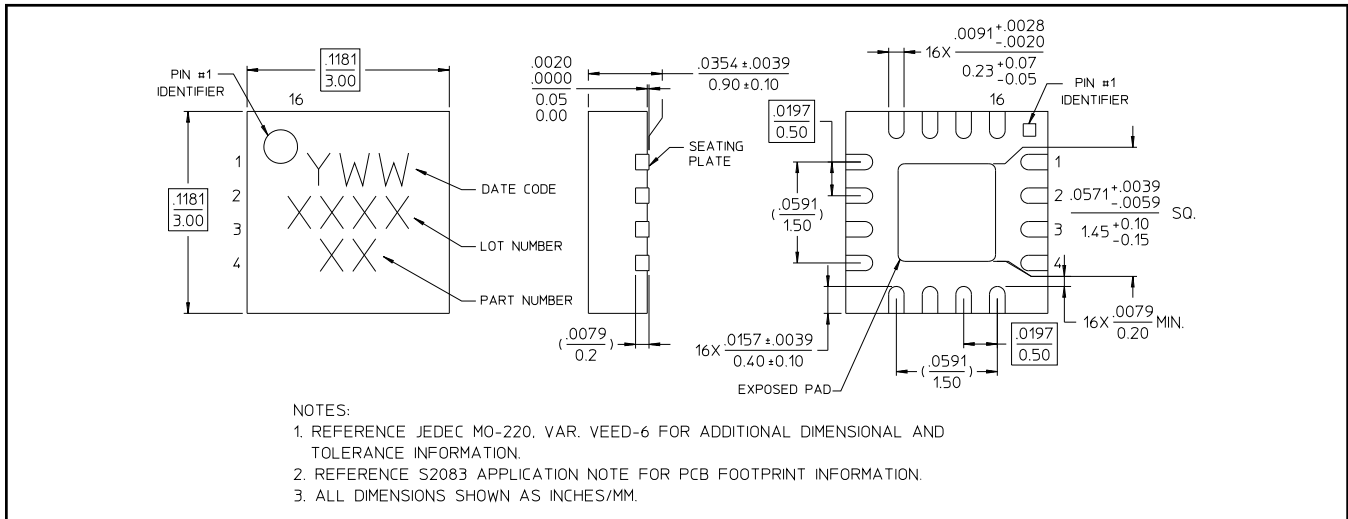

† Reference Application Note S2083 for lead-free solder reflow recommendations.  
Meets JEDEC moisture sensitivity level 1 requirements.  
Plating is 100% matte tin over copper.