

## Features

- Low Noise Figure
- Excellent Input Return Loss
- Single Voltage Bias 3 V
- Integrated Active Bias Circuit
- Current Adjustable 20-80 mA with an External Resistor
- High Linearity, OIP3 > 34 dBm
- Small Package: 2 mm PDFN-8LD
- RoHS\* Compliant and 260°C Reflow Compatible

## Description

The MAAL-010706 is a high dynamic range single stage MMIC LNA with excellent linearity and low noise figure designed for operation from 1.4 to 4.0 GHz. The LNA is packaged in an RoHS compliant leadless 2 mm 8-lead PDFN package.

This MMIC has an integrated active bias circuit allowing direct connection to +3 V voltage supply and minimizing variation over temperature and process. The bias current and gain can be set with external resistors to allow the user to customize the current and gain value to fit the application.

The MAAL-010706 offers less than 0.7 dB noise figure, more than 34 dBm OIP3 and 20 dB input return loss. The excellent input match, low noise figure and high OIP3 along with the flexibility of setting current and gain make this LNA ideal for 3G and 4G cellular infrastructure applications.

For optimum performance below 1.4 GHz the MAAL-010705 is recommended. The MAAL-010706 and MAAL-010705 share the package type and footprint.

## Functional Block Diagram

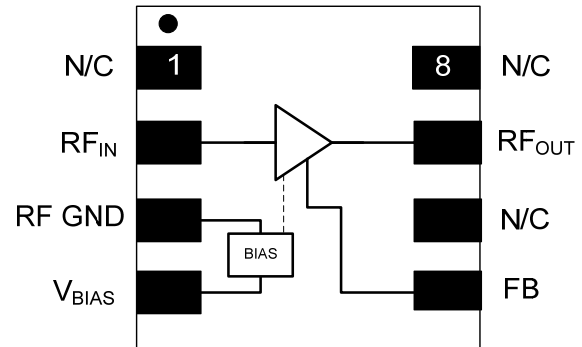

## Pin Configuration

| Pin No. | Pin Name          | Description   |
|---------|-------------------|---------------|
| 1       | N/C               | No Connection |
| 2       | RF <sub>IN</sub>  | RF Input      |
| 3       | RF GND            | RF Ground     |
| 4       | V <sub>BIAS</sub> | Bias Voltage  |
| 5       | FB                | Feedback      |
| 6       | N/C               | No Connection |
| 7       | RF <sub>OUT</sub> | RF Output     |
| 8       | N/C               | No Connection |

## Ordering Information <sup>1,2</sup>

| Part Number        | Package          |
|--------------------|------------------|
| MAAL-010706-TR3000 | tape and reel    |
| MAAL-010706-001SMB | evaluation board |

1. Reference Application Note M513 for reel size information.
2. All sample boards include 5 loose parts.

\* Restrictions on Hazardous Substances, European Union Directive 2002/95/EC.

## Electrical Specifications<sup>3</sup>: Freq = 1.85 GHz, Vd = 4 V, 25°C, Z<sub>0</sub> = 50 Ω

| Parameter          | Test Conditions                | Units | Min. | Typ. | Max. |
|--------------------|--------------------------------|-------|------|------|------|
| Gain               | -                              | dB    | 16.0 | 17.5 | -    |
| Output IP3         | Pout=5 dBm, Tone Spacing=1 MHz | dBm   | -    | 34.5 | -    |
| Output P1dB        | -                              | dBm   | 17.5 | 19   | -    |
| Input Return Loss  | -                              | dB    | -    | 21   | -    |
| Output Return Loss | -                              | dB    | -    | 15   | -    |
| Noise Figure       | -                              | dB    | -    | 0.60 | -    |
| Total Current      | IDQ=Id+IBias                   | mA    | -    | 60   | 70   |

3. Vd and Vbias are connected together to +4 V, R3 = 300 ohms and R4 = 240 ohms, reference recommended schematic on page 8.

## Absolute Maximum Ratings<sup>4,5</sup>

| Parameter                         | Absolute Max.  |
|-----------------------------------|----------------|
| Supply Voltage                    | +5.5 V         |
| Current                           | 100 mA         |
| Power Dissipation                 | 600 mW         |
| RF Input Power                    | 20 dBm         |
| Storage Temperature               | -55 to +150 °C |
| Operating Temperature             | -40 to +85 °C  |
| Junction Temperature <sup>6</sup> | +150 °C        |

4. Exceeding any one or combination of these limits may cause permanent damage to this device.

5. M/A-COM Technology Solutions does not recommend sustained operation near these survivability limits.

6. Typical thermal resistance (Θ<sub>jc</sub>) = 45 °C/W.

## Handling Procedures

Please observe the following precautions to avoid damage:

## Static Sensitivity

Gallium Arsenide Integrated Circuits are sensitive to electrostatic discharge (ESD) and can be damaged by static electricity. Proper ESD control techniques should be used when handling these class 1A devices.

## Typical Performance Curves: 4 V (over current)

Input Return Loss

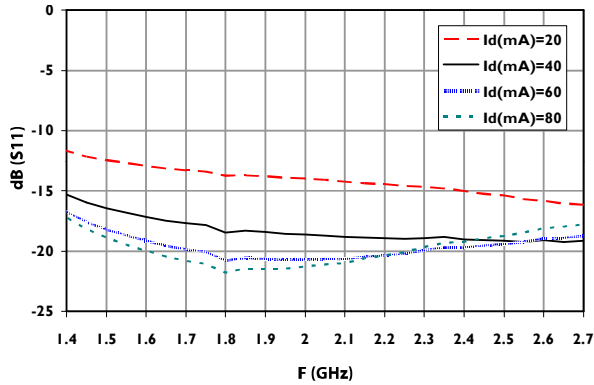

Output Return Loss

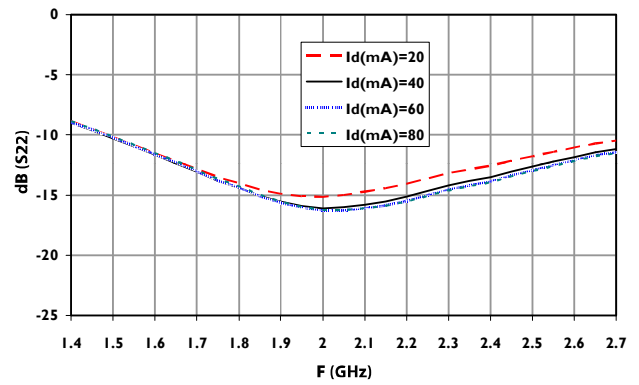

Gain

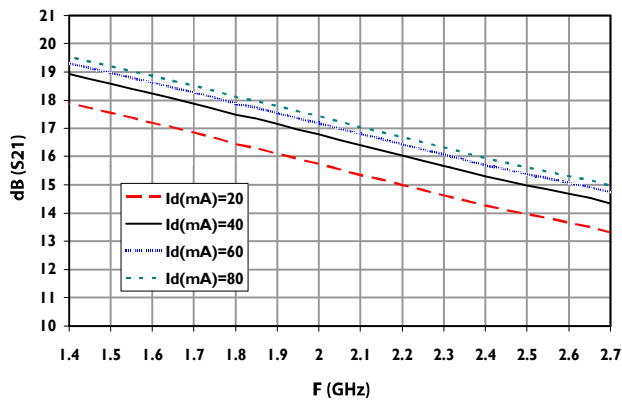

Noise Figure

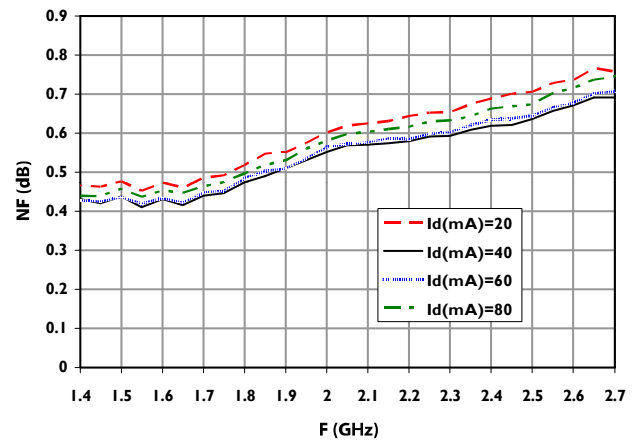

OIP3

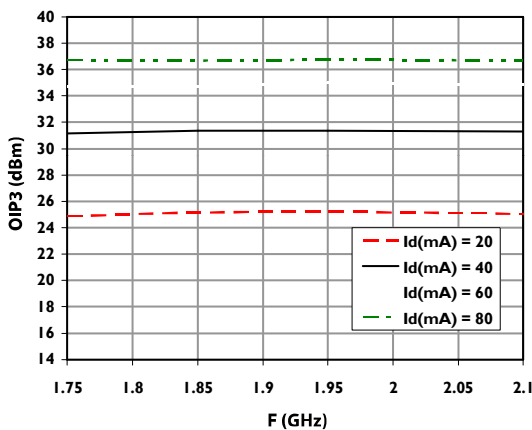

P1dB

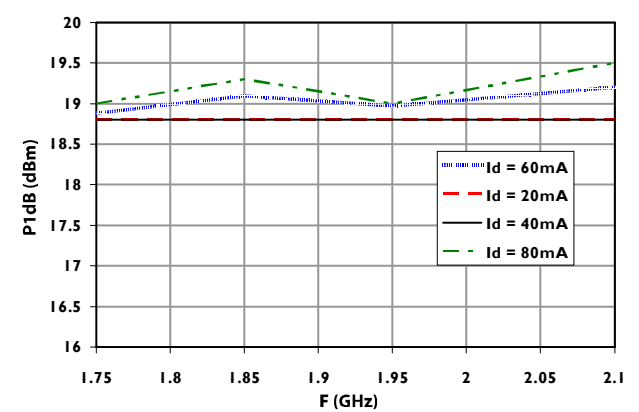

**ADVANCED:** Data Sheets contain information regarding a product M/A-COM Technology Solutions is considering for development. Performance is based on target specifications, simulated results, and/or prototype measurements. Commitment to develop is not guaranteed.  
**PRELIMINARY:** Data Sheets contain information regarding a product M/A-COM Technology Solutions has under development. Performance is based on engineering tests. Specifications are typical. Mechanical outline has been fixed. Engineering samples and/or test data may be available. Commitment to produce in volume is not guaranteed.

• **North America** Tel: 800.366.2266 • **Europe** Tel: +353.21.244.6400  
 • **India** Tel: +91.80.43537383 • **China** Tel: +86.21.2407.1588  
 Visit [www.macomtech.com](http://www.macomtech.com) for additional data sheets and product information.

M/A-COM Technology Solutions Inc. and its affiliates reserve the right to make changes to the product(s) or information contained herein without notice.

## Typical Performance Curves: 4 V (over R3)

Gain

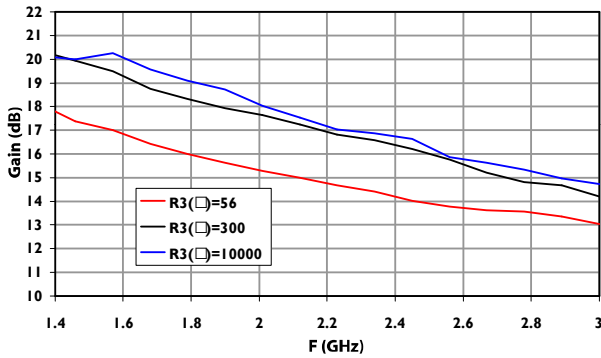

Noise Figure & Fmin

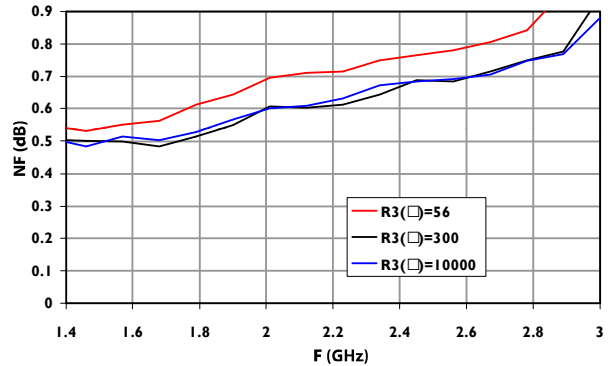

OIP3

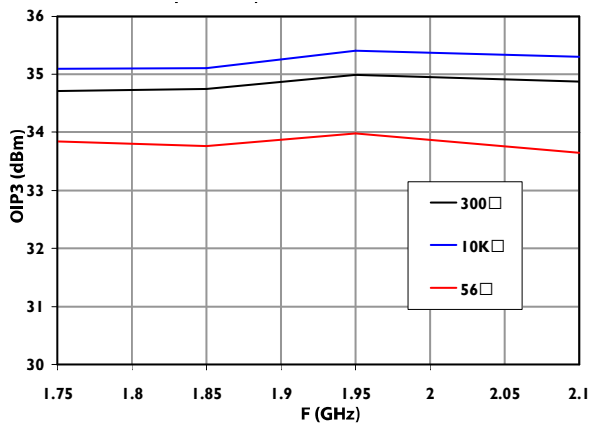

P1dB

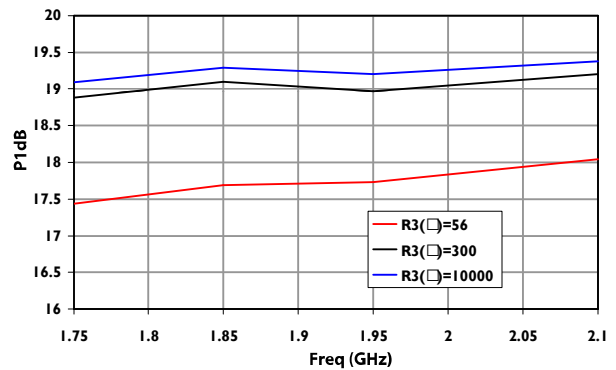

## Typical Performance Curves: 4 V (over temperature)

**Input Return Loss**

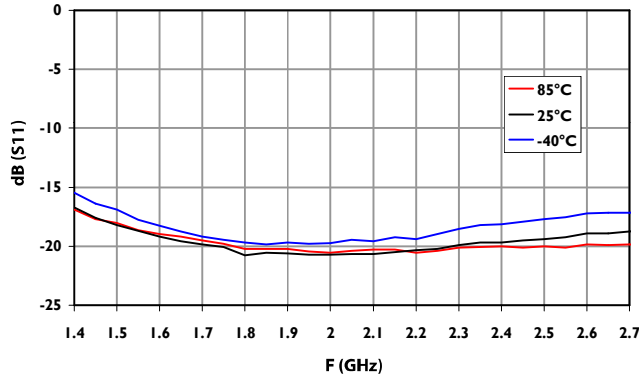

**Output Return Loss**

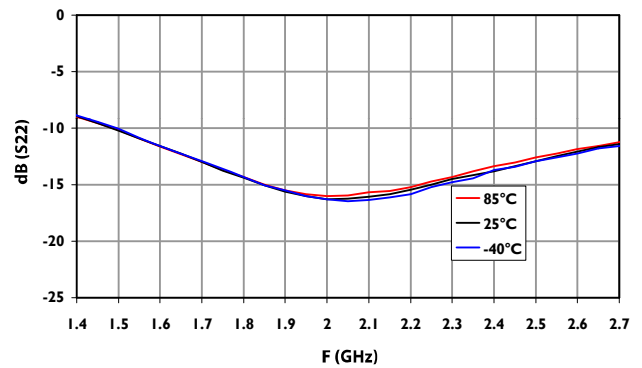

**Gain**

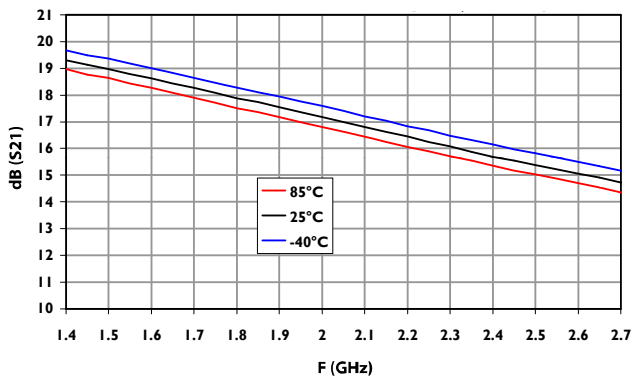

**Noise Figure**

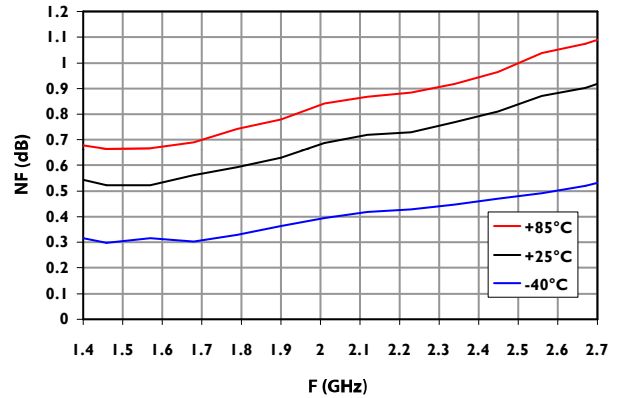

**OIP3**

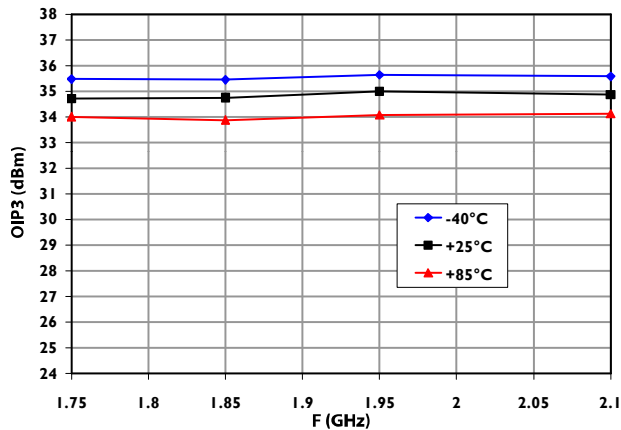

**P1dB**

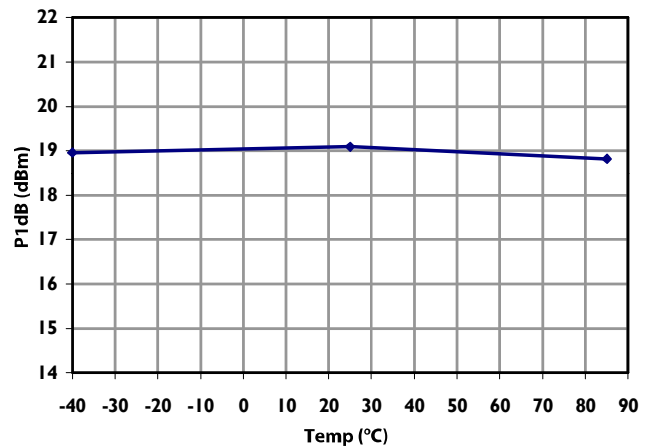

## Typical Performance Curves: 3 V

Input Return Loss

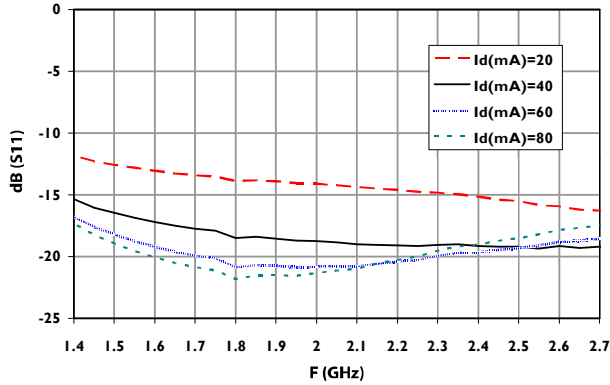

Output Return Loss

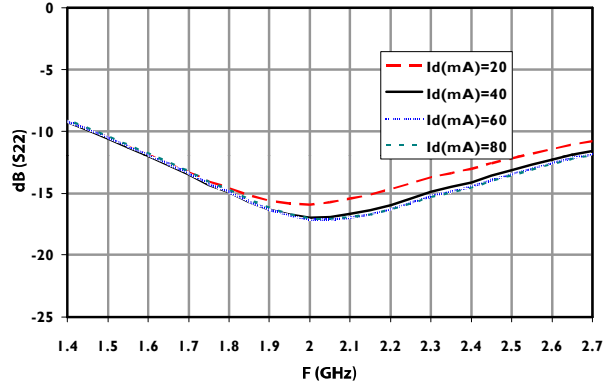

Gain

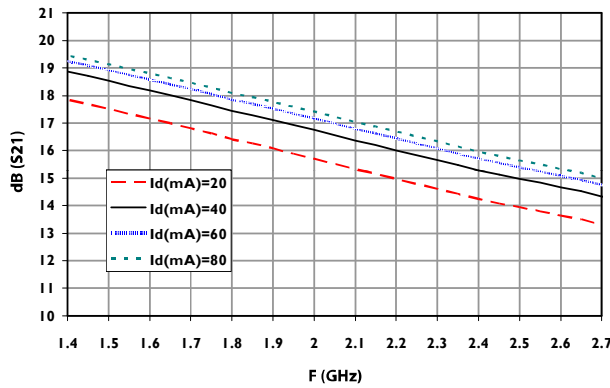

Noise Figure

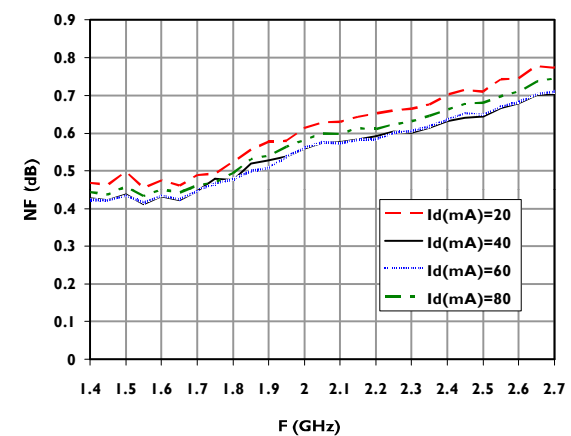

OIP3

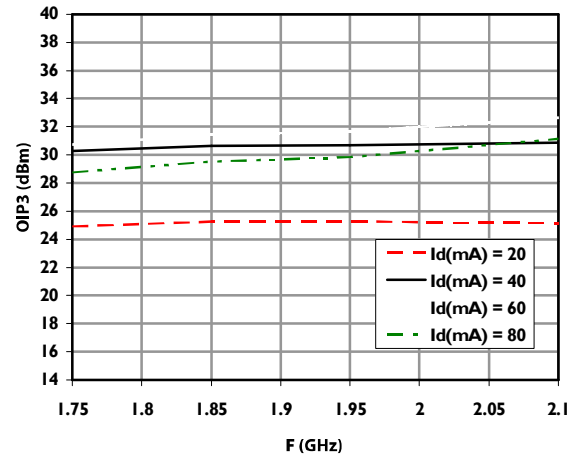

P1dB

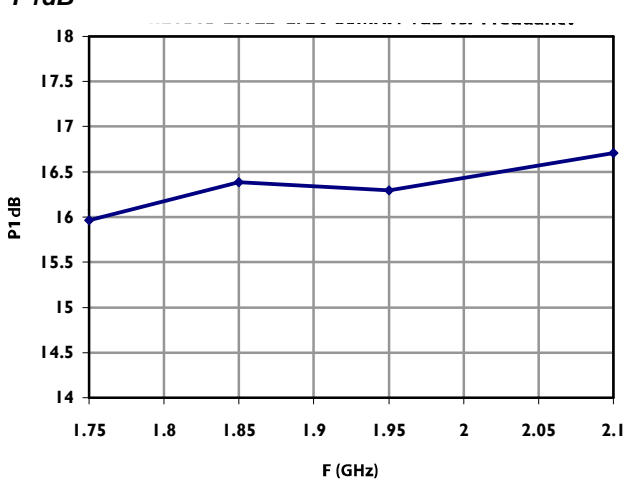

**ADVANCED:** Data Sheets contain information regarding a product M/A-COM Technology Solutions is considering for development. Performance is based on target specifications, simulated results, and/or prototype measurements. Commitment to develop is not guaranteed.  
**PRELIMINARY:** Data Sheets contain information regarding a product M/A-COM Technology Solutions has under development. Performance is based on engineering tests. Specifications are typical. Mechanical outline has been fixed. Engineering samples and/or test data may be available. Commitment to produce in volume is not guaranteed.

• **North America** Tel: 800.366.2266 • **Europe** Tel: +353.21.244.6400  
 • **India** Tel: +91.80.43537383 • **China** Tel: +86.21.2407.1588  
 Visit [www.macomtech.com](http://www.macomtech.com) for additional data sheets and product information.

M/A-COM Technology Solutions Inc. and its affiliates reserve the right to make changes to the product(s) or information contained herein without notice.

## S-Parameters<sup>7</sup>: 4 V

Reverse Isolation

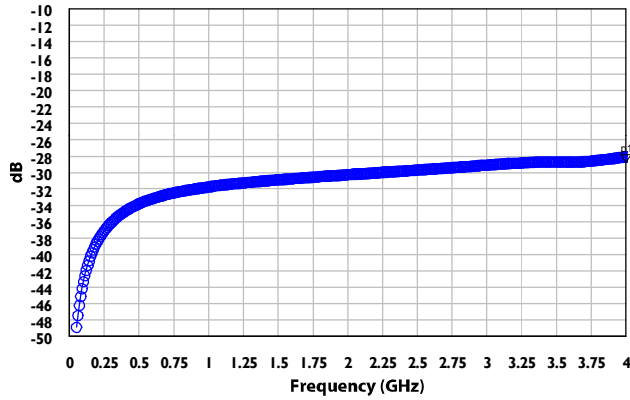

Gain

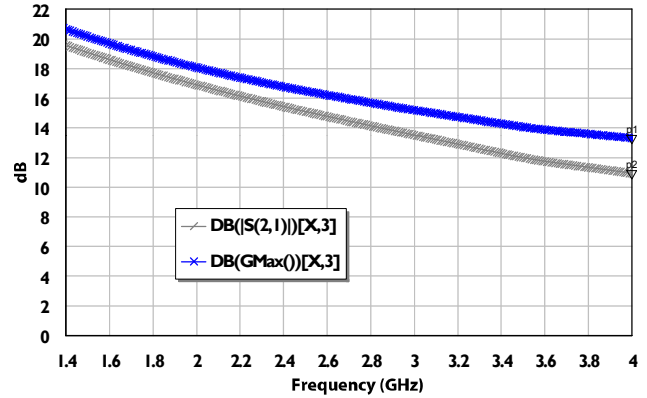

Output Return Loss

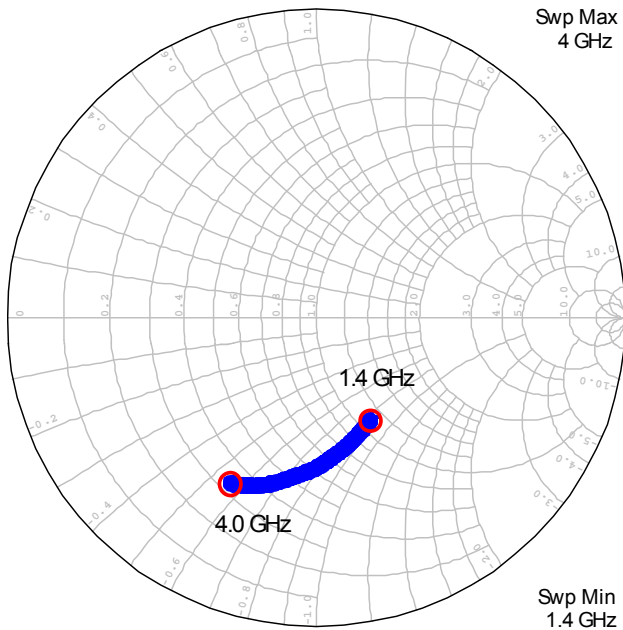

Input Return Loss

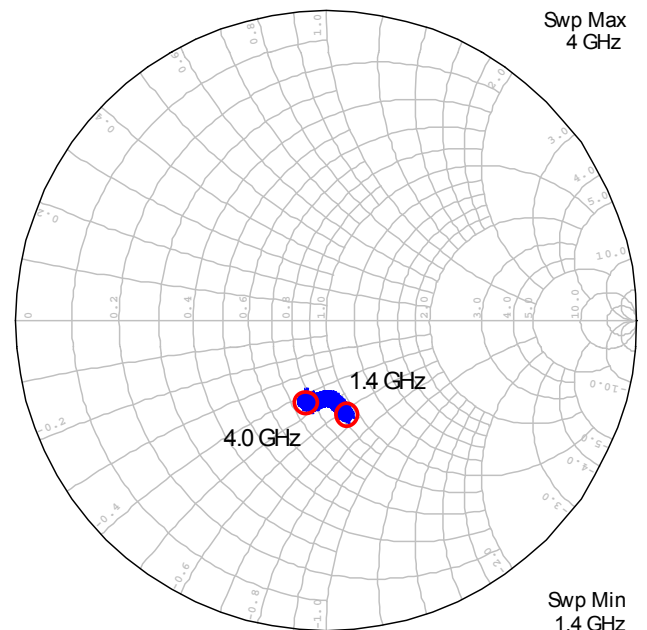

7. S-Parameters files are available for download at [macomtech.com](http://macomtech.com).

## Evaluation Board

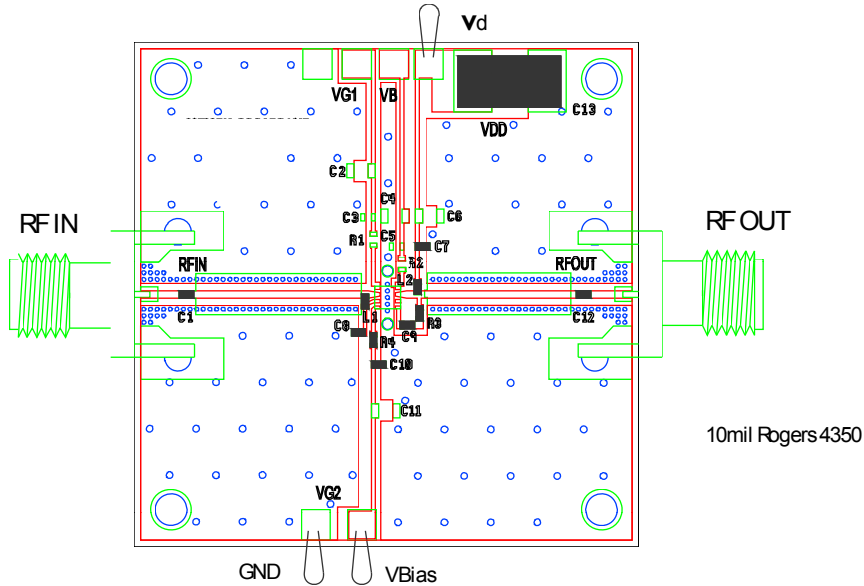

## Recommended Schematic

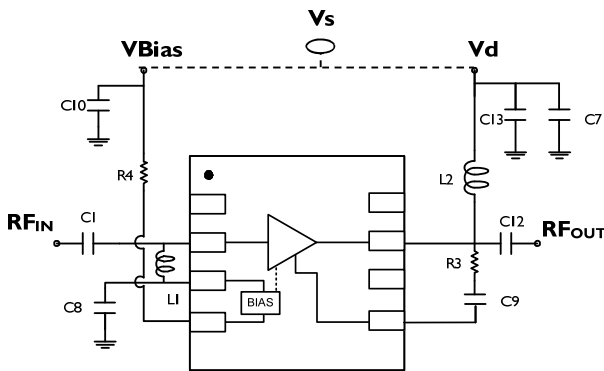

Vbias and Vd are separate connections on the evaluation board to give the option of varying Id without changing R4. They can be connected together to a single voltage supply during the measurement and in the final layout implementation of the PCB. If two different voltage supplies are used then apply Vd first and then VBias to turn on the LNA. To turn off the LNA disconnect Vbias first and then Vd. R3 is varied to obtain different levels of gain. R4 is varied to change the drain current Id.

## Component Values

| Component   | Value  | Package          |
|-------------|--------|------------------|
| C1, C12     | 100 pF | 0402             |
| C8, C10, C7 | 10 nF  | 0402             |
| C9          | 5.6 pF | 0402             |
| C13         | 100 μF | Tantalum, Size D |
| L1          | 8.2 nH | 0402             |
| L2          | 3.6 nH | 0402             |
| R3          | 300 Ω  | 0402             |
| R4          | 240 Ω  | 0402             |



## Lead-Free 2 mm 8-Lead PDFN<sup>†</sup>

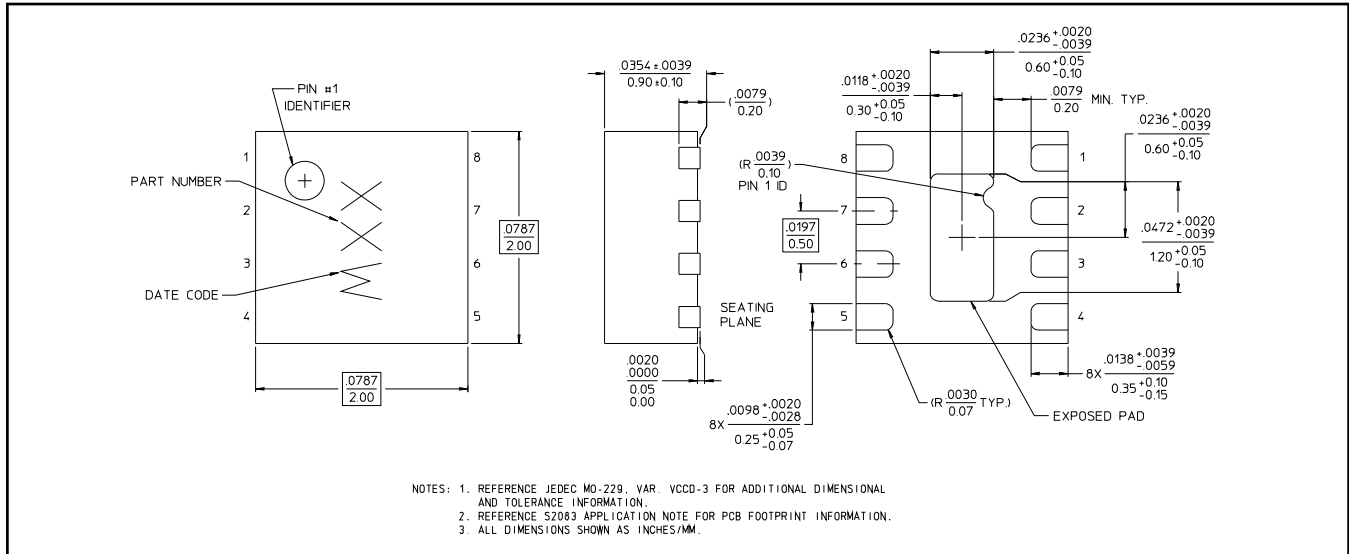

<sup>†</sup> Reference Application Note S2083 for lead-free solder reflow recommendations.  
Meets JEDEC moisture sensitivity level 1 requirements.