

## Broadband CATV Single Ended 3-Way Active Splitter 50 - 1100 MHz

Rev. V1

### Features

- 3-Way Splitter
- Single Ended Input and Outputs
- 4.5 dB and 6 dB Gain Configurations
- Single +5 Volt Supply
- Lead-Free 3 mm 16-Lead PQFN Package
- Halogen-Free “Green” Mold Compound
- RoHS\* Compliant and 260°C Reflow Compatible

### Description

M/A-COM's MAAM-007239 CATV 3-way active splitter is a GaAs MMIC which exhibits low noise figure and distortion in a lead-free 3mm 16-lead PQFN plastic package. The design employs a low noise, high linearity amplifier and power splitter functionality. The design features 75 Ω inputs and outputs.

The MAAM-007239 is ideally suited for multi-tuner set top boxes, home gateways, and other broadband internet based appliances.

The MAAM-007239 is fabricated using M/A-COM's PHEMT process to realize low noise and low distortion. The process features full passivation for robust performance and reliability.

### Functional Schematic

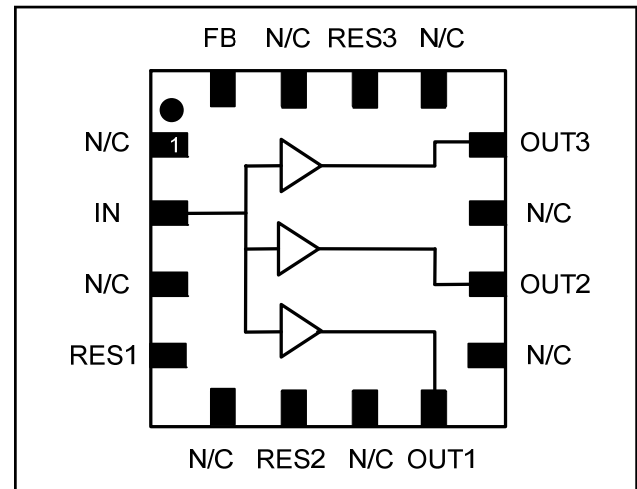

### Pin Configuration

Pin No.	Pin Name	Description
1	N/C	No Connection
2	IN	RF Input
3	N/C	No Connection
4	RES1	Resistor 1
5	N/C	No Connection
6	RES2	Resistor 2
7	N/C	No Connection
8	OUT1	RF Output 1
9	N/C	No Connection
10	OUT2	RF Output 2
11	N/C	No Connection
12	OUT3	RF Output 3
13	N/C	No Connection
14	RES3	Resistor 3
15	N/C	No Connection
16	FB	Feedback
17	Paddle <sup>3</sup>	RF and DC Ground

3. The exposed pad centered on the package bottom must be connected to RF and DC ground.

### Ordering Information<sup>1,2</sup>

Part Number	Package
MAAM-007239-TR1000	1000 piece reel
MAAM-007239-TR3000	3000 piece reel
MAAM-007239-001SMB	High Isolation Configuration
MAAM-007239-002SMB	Low Current Configuration

1. Reference Application Note M513 for reel size information.  
2. All sample boards include 5 loose parts.

\* Restrictions on Hazardous Substances, European Union Directive 2002/95/EC.

**ADVANCED:** Data Sheets contain information regarding a product M/A-COM Technology Solutions is considering for development. Performance is based on target specifications, simulated results, and/or prototype measurements. Commitment to develop is not guaranteed.  
**PRELIMINARY:** Data Sheets contain information regarding a product M/A-COM Technology Solutions has under development. Performance is based on engineering tests. Specifications are typical. Mechanical outline has been fixed. Engineering samples and/or test data may be available. Commitment to produce in volume is not guaranteed.

• **North America** Tel: 800.366.2266 / Fax: 978.366.2266  
• **Europe** Tel: 44.1908.574.200 / Fax: 44.1908.574.300  
• **Asia/Pacific** Tel: 81.44.844.8296 / Fax: 81.44.844.8298  
Visit [www.macomtech.com](http://www.macomtech.com) for additional data sheets and product information.

M/A-COM Technology Solutions Inc. and its affiliates reserve the right to make changes to the product(s) or information contained herein without notice.

## Broadband CATV Single Ended 3-Way Active Splitter 50 - 1100 MHz

Rev. V1

### Low Current Configuration

**Electrical Specifications: F = 50 - 1000 MHz, T<sub>A</sub> = 25° C, V<sub>DD</sub> = +5 Volts, Z<sub>0</sub> = 75 Ω**

Parameter	Test Conditions	Units	Min.	Typ.	Max.
Gain	IN to OUT1, IN to OUT2, IN to OUT3	dB	5.0	6.0	7.0
Gain Flatness	IN to OUT1, IN to OUT2, IN to OUT3	dB	-	1.0	1.8
Noise Figure	IN to OUT1, IN to OUT2, IN to OUT3	dB	-	4.5	5.0
Input Return Loss	IN	dB	-	15	-
Output Return Loss	OUT1, OUT2, OUT3	dB	-	20	-
Composite Triple Beat, CTB	132 channels, +15 dBmV/channel at the input	dBc	-	-77	-70
Composite Second Order, CSO	132 channels, +15 dBmV/channel at the input	dBc	-	-65	-56
Crossmodulation, XMOD	132 channels, +15 dBmV/channel at the input	dBc	-	-65	-
Reverse Isolation	OUT1 to IN, OUT2 to IN, OUT3 to IN	dB	-	23	-
Output to Output Isolation	OUT1 to OUT2 or OUT3	dB	-	22	-
P1dB	400 MHz	dBm	-	17	-
OIP3	50 MHz / 1 GHz Two Tones at 6 MHz Spacing, P <sub>IN</sub> = -10 dBm per Tone	dBm	-	23	-
OIP2	50 MHz / 1 GHz Two Tones at 6 MHz Spacing, P <sub>IN</sub> = -10 dBm per Tone	dBm	-	48	-
I <sub>DD</sub>	V <sub>DD</sub> = +5 Volts	mA	-	125	150

### High Isolation Configuration

**Typical Performance: F = 50 - 1000 MHz, T<sub>A</sub> = 25° C, V<sub>DD</sub> = +5 Volts, Z<sub>0</sub> = 75 Ω**

Parameter	Test Conditions	Units	Min.	Typ.	Max.
Gain	IN to OUT1, IN to OUT2, IN to OUT3	dB	-	4.6	-
Gain Flatness	IN to OUT1, IN to OUT2, IN to OUT3	dB	-	0.8	-
Noise Figure	IN to OUT1, IN to OUT2, IN to OUT3	dB	-	4.5	-
Input Return Loss	IN	dB	-	17	-
Output Return Loss	OUT1, OUT2, OUT3	dB	-	12	-
Composite Triple Beat, CTB	132 channels, +15 dBmV/channel at the input	dBc	-	-83	-
Composite Second Order, CSO	132 channels, +15 dBmV/channel at the input	dBc	-	-70	-
Crossmodulation, XMOD	132 channels, +15 dBmV/channel at the input	dBc	-	-65	-
Reverse Isolation	OUT1 to IN, OUT2 to IN, OUT3 to IN	dB	-	25	-
Output to Output Isolation	OUT1 to OUT2 or OUT3	dB	-	32	-
P1dB	400 MHz	dBm	-	19	-
OIP3	50 MHz / 1 GHz Two Tones at 6 MHz Spacing, P <sub>IN</sub> = -10 dBm per Tone	dBm	-	27	-
OIP2	50 MHz / 1 GHz Two Tones at 6 MHz Spacing, P <sub>IN</sub> = -10 dBm per Tone	dBm	-	52	-
I <sub>DD</sub>	V <sub>DD</sub> = +5 Volts	mA	-	210	-

2

**ADVANCED:** Data Sheets contain information regarding a product M/A-COM Technology Solutions is considering for development. Performance is based on target specifications, simulated results, and/or prototype measurements. Commitment to develop is not guaranteed.

**PRELIMINARY:** Data Sheets contain information regarding a product M/A-COM Technology Solutions has under development. Performance is based on engineering tests. Specifications are typical. Mechanical outline has been fixed. Engineering samples and/or test data may be available. Commitment to produce in volume is not guaranteed.

• **North America** Tel: 800.366.2266 / Fax: 978.366.2266

• **Europe** Tel: 44.1908.574.200 / Fax: 44.1908.574.300

• **Asia/Pacific** Tel: 81.44.844.8296 / Fax: 81.44.844.8298

Visit [www.macomtech.com](http://www.macomtech.com) for additional data sheets and product information.

M/A-COM Technology Solutions Inc. and its affiliates reserve the right to make changes to the product(s) or information contained herein without notice.

## Recommended PCB configuration Low Current Configuration

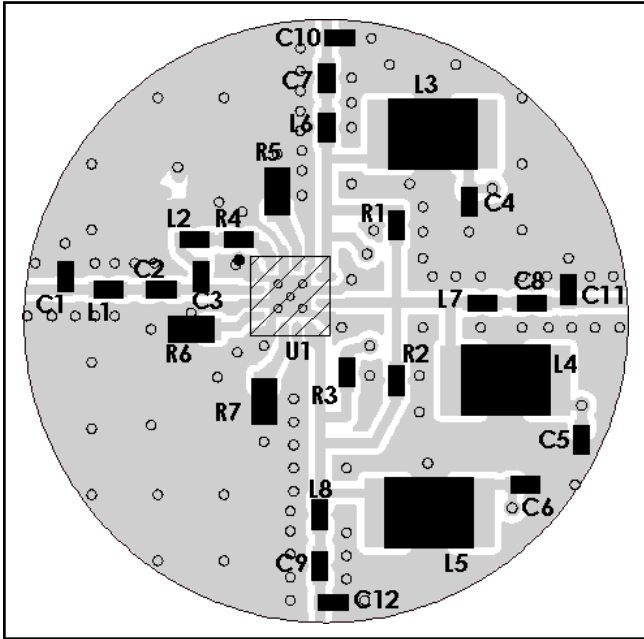

## Off-Chip Component Values<sup>4</sup> Low Current Configuration

Component	Value	Package
C1	1 pF	0402
C2 - C9	0.01 $\mu$ F	0402
C10 - C12	0.5 pF	0402
L1, L2	11 nH	0402
L3 - L5	1 $\mu$ H	1210
L6 - L8	12 nH	0402
R1 - R3	620 $\Omega$	0402
R4	68 $\Omega$	0402
R5 - R7	18 $\Omega$	0603

4. L3 - L5 supplied from EPCOS, part number B82422A1102K100

## Schematic Including Off-Chip Components Low Current Configuration

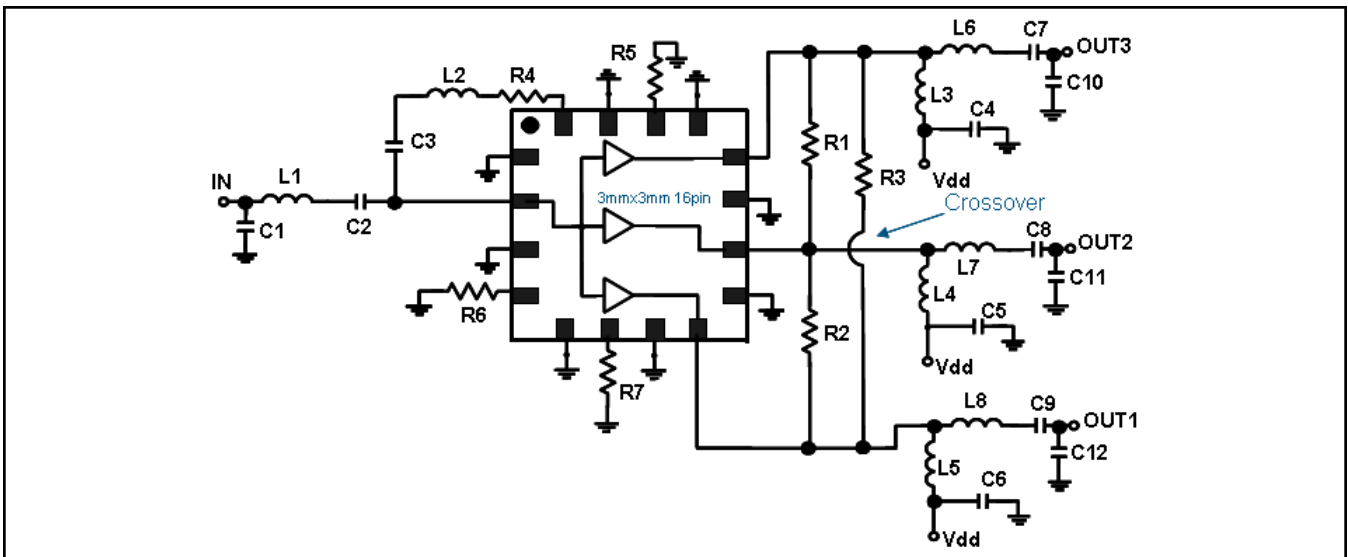

## Broadband CATV Single Ended 3-Way Active Splitter 50 - 1100 MHz

Rev. V1

### Absolute Maximum Ratings <sup>5,6,7</sup>

Parameter	Absolute Maximum
Max Input Power	+12 dBm
Vbias	+10.0 V
Operating Temperature	-40°C to +85°C
Junction Temperature <sup>8</sup>	150°C
Storage Temperature	-65°C to +125°C

- Exceeding any one or combination of these limits may cause permanent damage to this device.
- M/A-COM does not recommend sustained operation near these survivability limits.
- These operating conditions will ensure MTTF > 1 x 10<sup>6</sup> hours.
- Junction Temperature (T<sub>J</sub>) = T<sub>C</sub> + (Θ<sub>JC</sub>) \* (V\*I)  
Typical thermal resistance (Θ<sub>JC</sub>) = 42° C/W.
  - For T<sub>C</sub> = 25°C,  
(Low Current Configuration) T<sub>J</sub> = 51 °C @ 5 V, 125 mA  
(High Current Configuration) T<sub>J</sub> = 69 °C @ 5 V, 210 mA
  - For T<sub>C</sub> = 85°C,  
(Low Current Configuration) T<sub>J</sub> = 111 °C @ 5 V, 125 mA  
(High Current Configuration) T<sub>J</sub> = 129 °C @ 5 V, 210 mA

### Handling Procedures

Please observe the following precautions to avoid damage:

### Static Sensitivity

Gallium Arsenide Integrated Circuits are sensitive to electrostatic discharge (ESD) and can be damaged by static electricity. Proper ESD control techniques should be used when handling these devices.

### Lead-Free 3 mm 16-Lead PQFN<sup>†</sup>

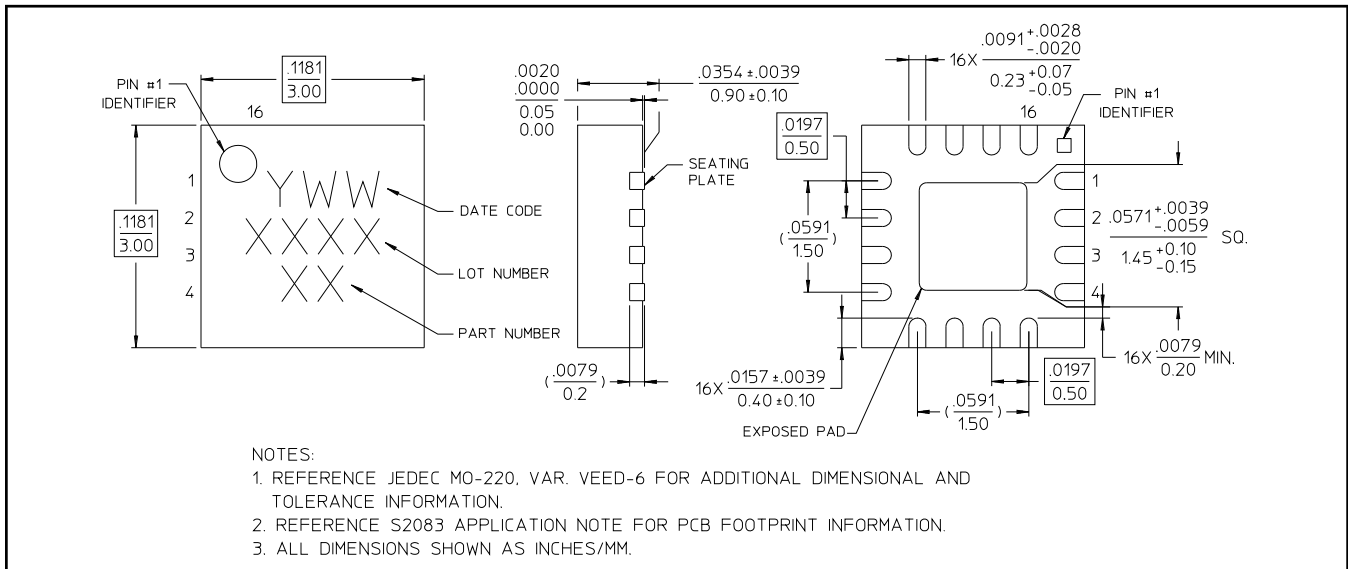

<sup>†</sup> Reference Application Note S2083 for lead-free solder reflow recommendations.  
 Meets JEDEC moisture sensitivity level 1 requirements.  
 Plating is 100% matte tin over copper.

## Typical Performance Curves: Low Current Configuration

**Gain - OUT1**

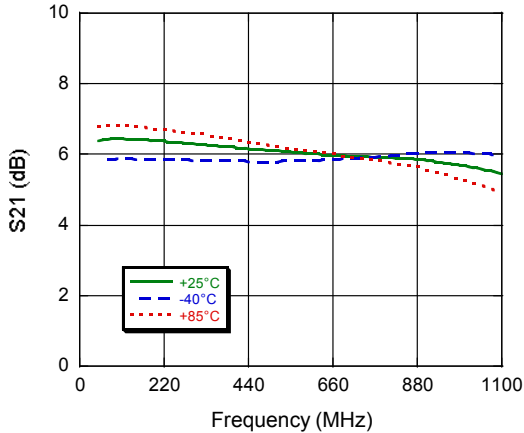

**Gain - OUT2**

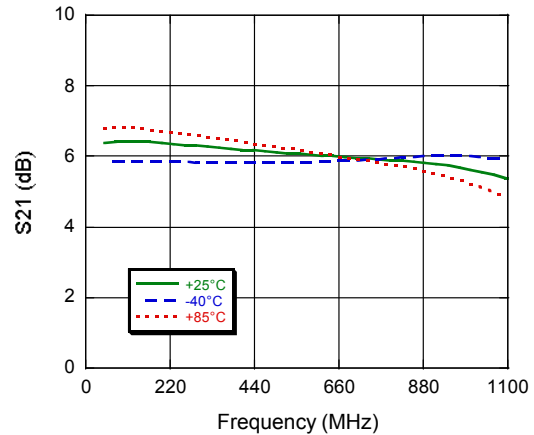

**Gain - OUT3**

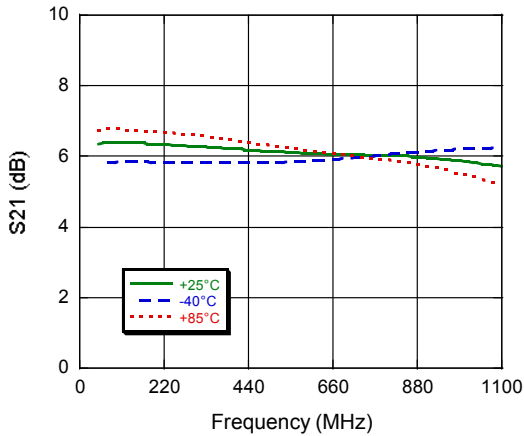

**Gain - typical all ports - to 3 GHz**

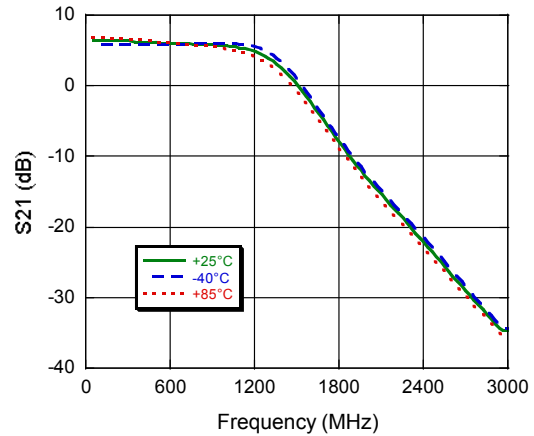

**Input Return Loss**

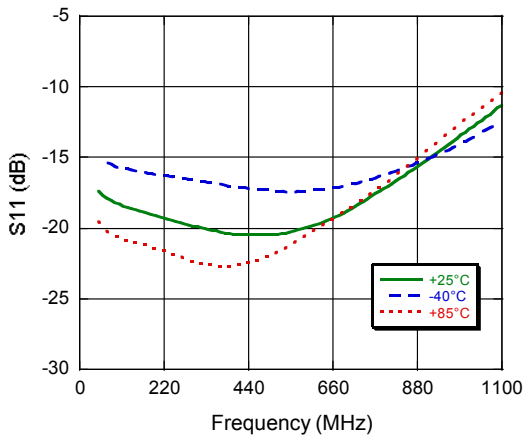

**Out1 - Return Loss**

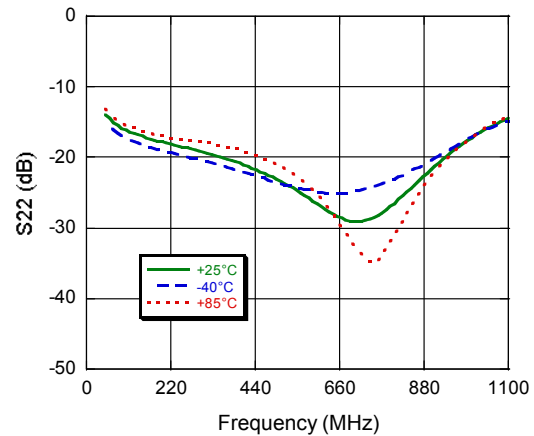

**ADVANCED:** Data Sheets contain information regarding a product M/A-COM Technology Solutions is considering for development. Performance is based on target specifications, simulated results, and/or prototype measurements. Commitment to develop is not guaranteed.  
**PRELIMINARY:** Data Sheets contain information regarding a product M/A-COM Technology Solutions has under development. Performance is based on engineering tests. Specifications are typical. Mechanical outline has been fixed. Engineering samples and/or test data may be available. Commitment to produce in volume is not guaranteed.

- **North America** Tel: 800.366.2266 / Fax: 978.366.2266
- **Europe** Tel: 44.1908.574.200 / Fax: 44.1908.574.300
- **Asia/Pacific** Tel: 81.44.844.8296 / Fax: 81.44.844.8298

Visit [www.macomtech.com](http://www.macomtech.com) for additional data sheets and product information.

M/A-COM Technology Solutions Inc. and its affiliates reserve the right to make changes to the product(s) or information contained herein without notice.

## Typical Performance Curves: Low Current Configuration

**Out2 - Return Loss**

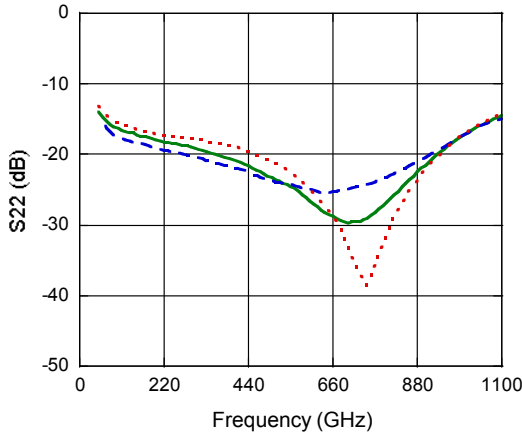

**Out3 - Return Loss**

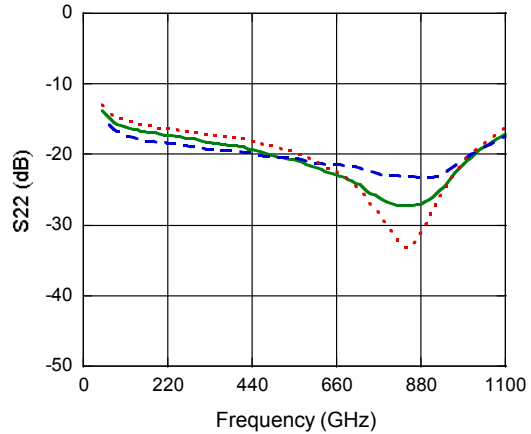

**Reverse Isolation**

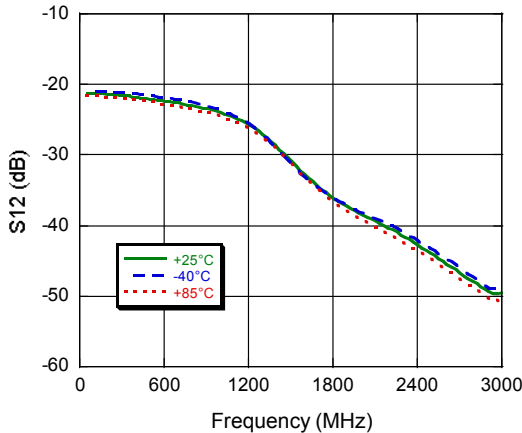

**OUT - OUT Isolation - to 1 GHZ**

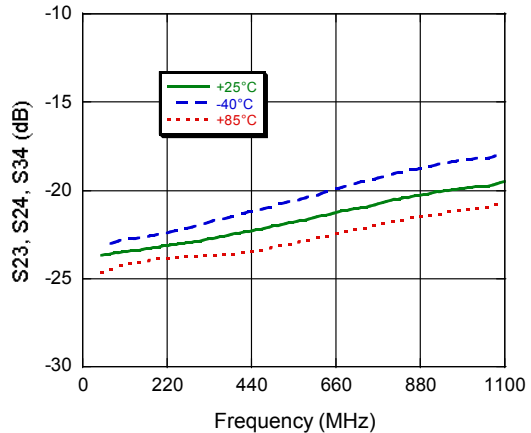

**OUT - OUT Isolation - to 3 GHZ**

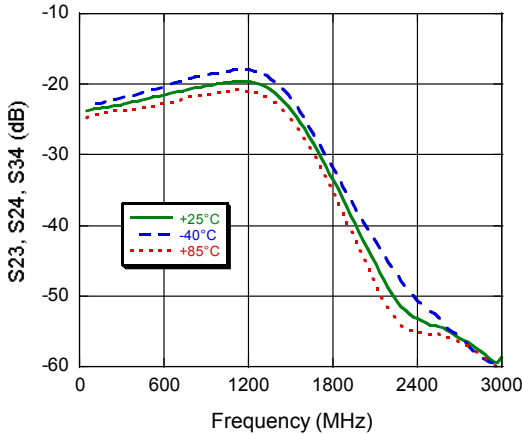

**Noise Figure - Typical for all ports**

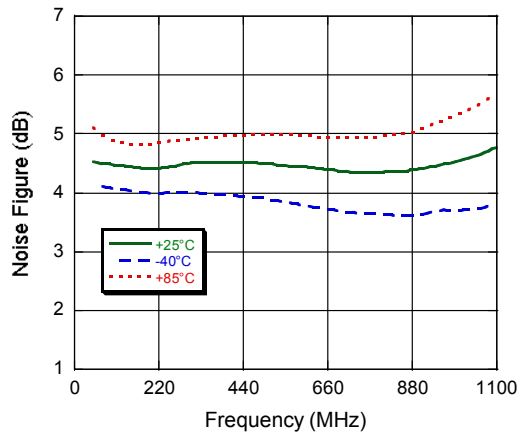

**ADVANCED:** Data Sheets contain information regarding a product M/A-COM Technology Solutions is considering for development. Performance is based on target specifications, simulated results, and/or prototype measurements. Commitment to develop is not guaranteed.  
**PRELIMINARY:** Data Sheets contain information regarding a product M/A-COM Technology Solutions has under development. Performance is based on engineering tests. Specifications are typical. Mechanical outline has been fixed. Engineering samples and/or test data may be available. Commitment to produce in volume is not guaranteed.

- **North America** Tel: 800.366.2266 / Fax: 978.366.2266
- **Europe** Tel: 44.1908.574.200 / Fax: 44.1908.574.300
- **Asia/Pacific** Tel: 81.44.844.8296 / Fax: 81.44.844.8298

Visit [www.macomtech.com](http://www.macomtech.com) for additional data sheets and product information.

M/A-COM Technology Solutions Inc. and its affiliates reserve the right to make changes to the product(s) or information contained herein without notice.

## Recommended PCB configuration High Isolation Configuration

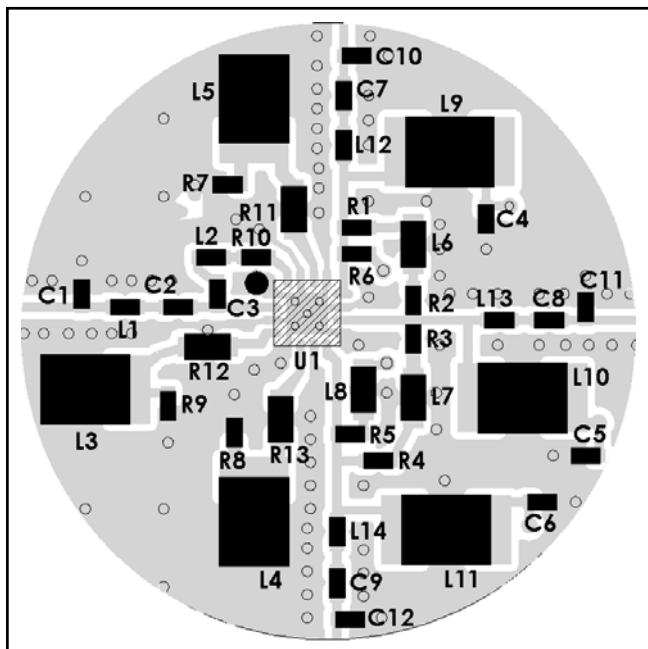

## Off-Chip Component Values<sup>9</sup> High Isolation Configuration

Component	Value	Package
C1	1 pF	0402
C2 - C9	0.01 $\mu$ F	0402
C10 - C12	0.5 pF	0402
L1	11 nH	0402
L2	19 nH	0402
L3 - L5, L9 - L11	1 $\mu$ H	1210
L6	100 nH	0603
L7	110 nH	0603
L8	82 nH	0603
L12 - L14	12 nH	0402
R1 - R6	270 $\Omega$	0402
R7 - R9	22 $\Omega$	0402
R10	100 $\Omega$	0402
R11 - R13	8.2 $\Omega$	0603

9. L3 - L5 and L9 - L11 supplied from EPCOS, part number B82422A1102K100.

## Schematic Including Off-Chip Components High Isolation Configuration

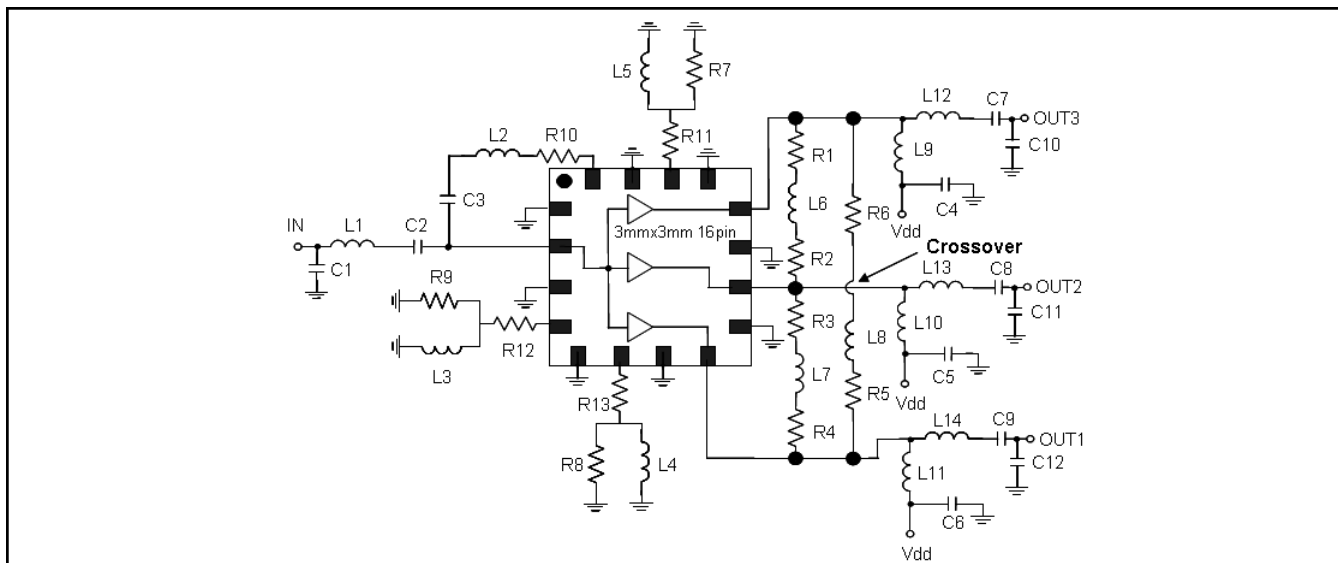

7

**ADVANCED:** Data Sheets contain information regarding a product M/A-COM Technology Solutions is considering for development. Performance is based on target specifications, simulated results, and/or prototype measurements. Commitment to develop is not guaranteed.  
**PRELIMINARY:** Data Sheets contain information regarding a product M/A-COM Technology Solutions has under development. Performance is based on engineering tests. Specifications are typical. Mechanical outline has been fixed. Engineering samples and/or test data may be available. Commitment to produce in volume is not guaranteed.

- **North America** Tel: 800.366.2266 / Fax: 978.366.2266
- **Europe** Tel: 44.1908.574.200 / Fax: 44.1908.574.300
- **Asia/Pacific** Tel: 81.44.844.8296 / Fax: 81.44.844.8298

Visit [www.macomtech.com](http://www.macomtech.com) for additional data sheets and product information.

M/A-COM Technology Solutions Inc. and its affiliates reserve the right to make changes to the product(s) or information contained herein without notice.

## Typical Performance Curves: High Isolation Configuration

**Gain - OUT1**

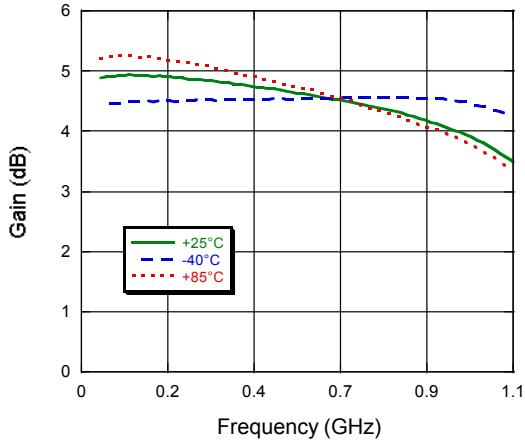

**Gain - OUT2**

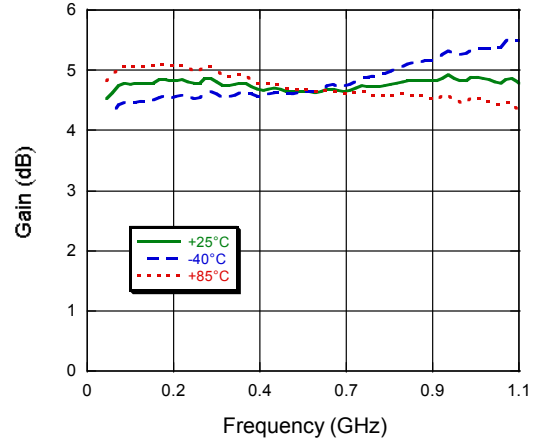

**Gain - OUT3**

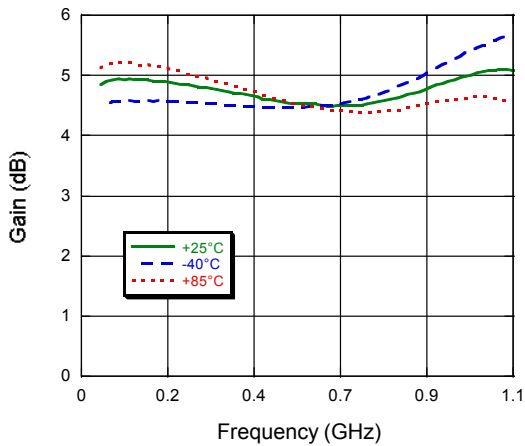

**Gain - typical all ports - to 3 GHz**

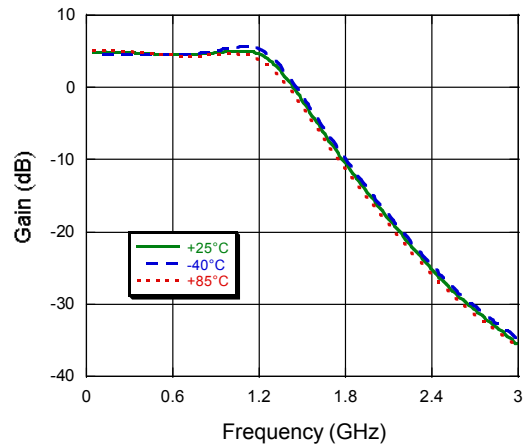

**Input Return Loss**

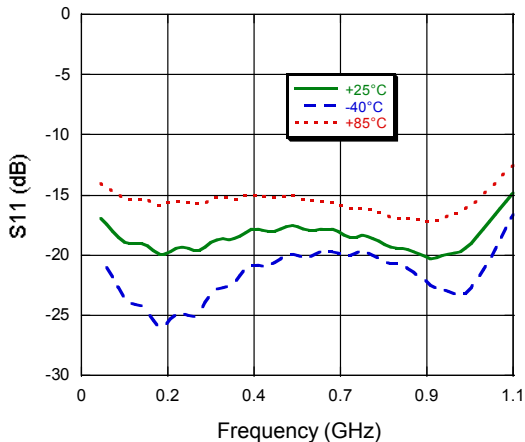

**Out1 - Return Loss**

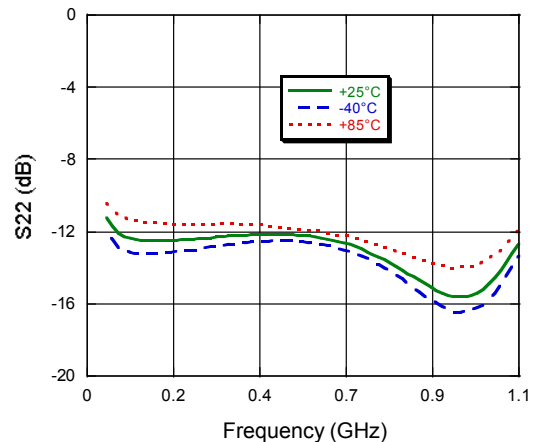

**ADVANCED:** Data Sheets contain information regarding a product M/A-COM Technology Solutions is considering for development. Performance is based on target specifications, simulated results, and/or prototype measurements. Commitment to develop is not guaranteed.  
**PRELIMINARY:** Data Sheets contain information regarding a product M/A-COM Technology Solutions has under development. Performance is based on engineering tests. Specifications are typical. Mechanical outline has been fixed. Engineering samples and/or test data may be available. Commitment to produce in volume is not guaranteed.

- **North America** Tel: 800.366.2266 / Fax: 978.366.2266
- **Europe** Tel: 44.1908.574.200 / Fax: 44.1908.574.300
- **Asia/Pacific** Tel: 81.44.844.8296 / Fax: 81.44.844.8298

Visit [www.macomtech.com](http://www.macomtech.com) for additional data sheets and product information.

M/A-COM Technology Solutions Inc. and its affiliates reserve the right to make changes to the product(s) or information contained herein without notice.



## Typical Performance Curves: High Isolation Configuration

**OUT2 - Return Loss**

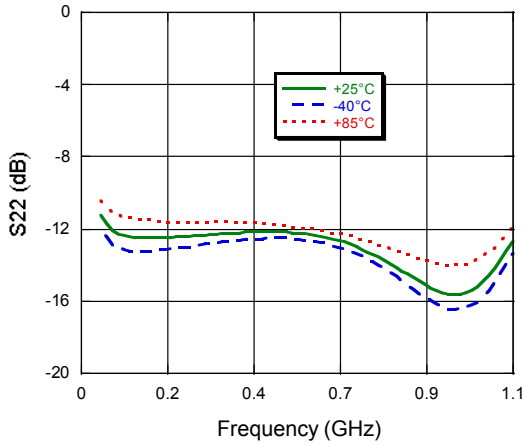

**OUT3 - Return Loss**

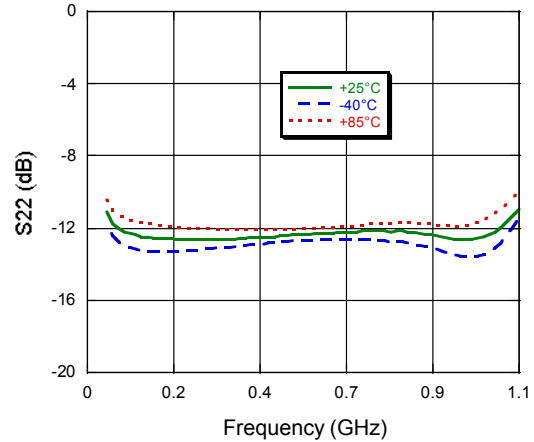

**Noise Figure - Typical for all ports**

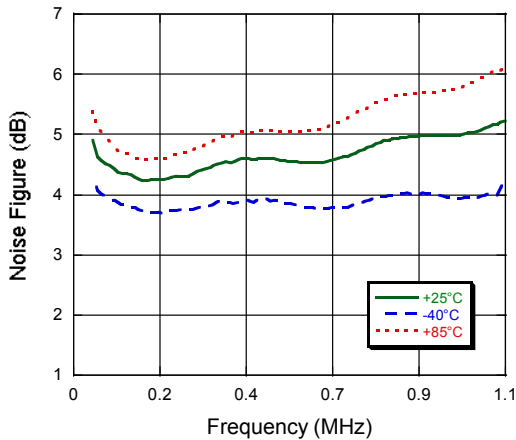

**OUT1 - OUT2 Isolation**

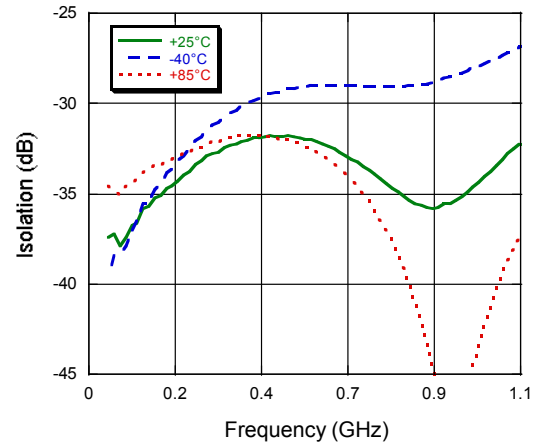

**OUT1 - OUT3 Isolation**

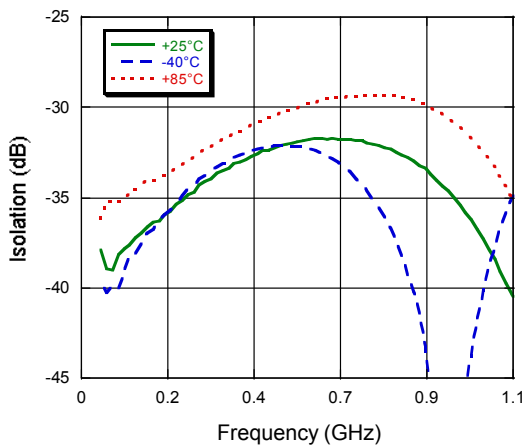

**OUT2 - OUT3 Isolation**

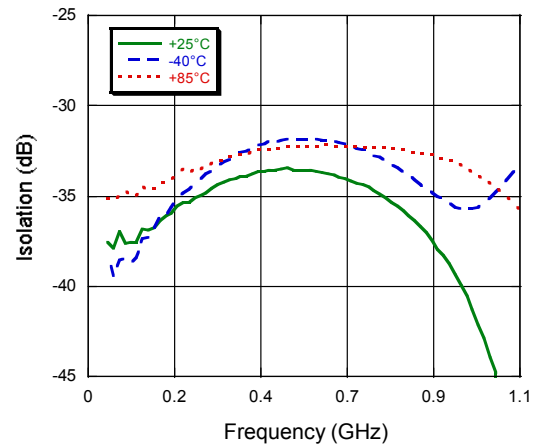

**ADVANCED:** Data Sheets contain information regarding a product M/A-COM Technology Solutions is considering for development. Performance is based on target specifications, simulated results, and/or prototype measurements. Commitment to develop is not guaranteed.

**PRELIMINARY:** Data Sheets contain information regarding a product M/A-COM Technology Solutions has under development. Performance is based on engineering tests. Specifications are typical. Mechanical outline has been fixed. Engineering samples and/or test data may be available. Commitment to produce in volume is not guaranteed.

- **North America** Tel: 800.366.2266 / Fax: 978.366.2266
- **Europe** Tel: 44.1908.574.200 / Fax: 44.1908.574.300
- **Asia/Pacific** Tel: 81.44.844.8296 / Fax: 81.44.844.8298

Visit [www.macomtech.com](http://www.macomtech.com) for additional data sheets and product information.

M/A-COM Technology Solutions Inc. and its affiliates reserve the right to make changes to the product(s) or information contained herein without notice.