

Features

- 75 Ω Input / Output Match
- Low Noise Figure: 2.2 dB
- High Gain: 22 dB
- High Linearity: -74 dBc CTB, -62 dBc CSO
- High ESD Threshold: HBM Class 1B
- Lead Free SOT-89 Package
- Halogen-Free "Green" Mold Compound
- RoHS* Compliant and 260°C Reflow Compatible

Description

The MAAM-010373 CATV amplifier is a GaAs MMIC that exhibits low distortion and high gain in a lead-free surface mount package.

The MAAM-010373 employs a monolithic single stage design featuring a convenient 75 Ω input/output impedance that minimizes the number of external components required.

The MAAM-010373 is fabricated using a pHEMT process to realize low noise and low distortion. The process features full passivation for robust performance and reliability.

Functional Schematic

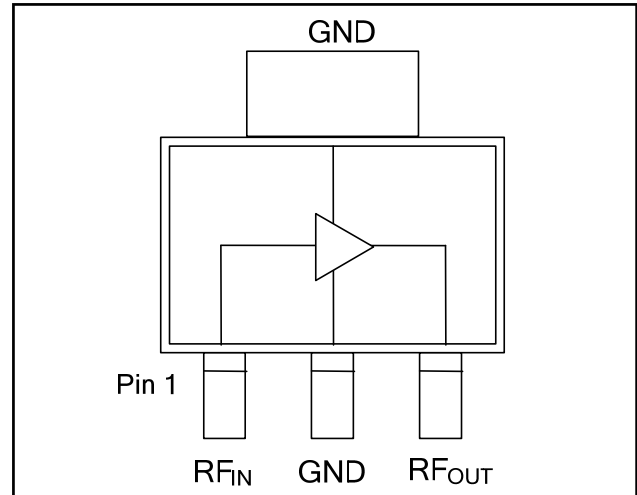

Pin Configuration

Pin No.	Pin Name	Description
1	RF _{IN}	RF Input
2	GND	Ground
3	RF _{OUT}	RF Output / Drain Supply

Absolute Maximum Ratings ^{3,4,5}

Parameter	Absolute Maximum
RF Input Power	6 dBm
Voltage	10 volts
Operating Temperature	-40°C to +85°C
Junction Temperature ⁶	+150°C
Storage Temperature	-65°C to +150°C

- Exceeding any one or combination of these limits may cause permanent damage to this device.
- M/A-COM Technology Solutions does not recommend sustained operation near these survivability limits.
- Operating at nominal conditions with $T_J \leq +150^\circ\text{C}$ will ensure MTTF > 1×10^6 hours.
- Junction Temperature (T_J) = $T_C + \Theta_{jc} * ((V * I) - (P_{OUT} - P_{IN}))$
Typical thermal resistance (Θ_{jc}) = 32 °C/W.
 - For $T_C = 25^\circ\text{C}$,
 $T_J = 63^\circ\text{C} @ 8 \text{ V}, 148 \text{ mA}$
 - For $T_C = 85^\circ\text{C}$,
 $T_J = 123^\circ\text{C} @ 8 \text{ V}, 148 \text{ mA}$

Ordering Information ^{1,2}

Part Number	Package
MAAM-010373-000000	Bulk Packaging
MAAM-010373-TR3000	3000 piece reel
MAAM-010373-001SMB	Sample Test Board

- Reference Application Note M513 for reel size information.
- All sample boards include 5 loose parts.

* Restrictions on Hazardous Substances, European Union Directive 2002/95/EC.

Electrical Specifications: $T_A = 25^\circ\text{C}$, Freq: 50 - 1000 MHz, $V_{DD} = 8$ Volts, $Z_0 = 75 \Omega$

Parameter	Test Conditions	Units	Min.	Typ.	Max.
Gain	—	dB	20	22	24
Gain Flatness	—	dB	—	+/- 0.5	1
Noise Figure	—	dB	—	2.2	3
Input Return Loss	—	dB	—	18	—
Output Return Loss	—	dB	—	20	—
Reverse Isolation	—	dB	—	25	—
Output IP3	6 MHz Spacing, -10 dBm output per tone	dBm	—	40	—
Output IP2	6 MHz Spacing, -10 dBm output per tone	dBm	—	50	—
Composite Triple Beat, CTB	80 ch. NTSC flat, +33 dBmV / ch. at the output	dBc	—	-74	—
Composite Second Order, CSO	80 ch. NTSC flat +33 dBmV / ch. at the output	dBc	—	-62	—
P1dB	403.25 MHz	dBm	—	25	—
I_{DD}	8 Volts	mA	—	148	165

Schematic Including Off-Chip Components

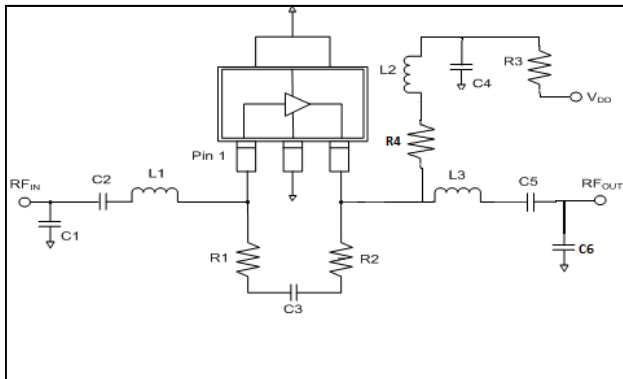

Off-Chip Component Values

Component	Value	Package
C1	1.5 pF	0402
C2, C3, C4	0.01 μF	0402
C5	270 pF	0402
C6	0.5 pF	0402
L1	10 nH	0402
L2 ⁷	1 μH	1210
L3	8.2 nH	0402
R1	360 Ω	0402
R2	715 Ω	0402
R3	0 Ω	0805
R4	2 Ω	0805

7. L2 is EPCOS part number B82422A1102K100.

Recommended PCB Layout—Component Side Metal Layer (Viewed from Top)

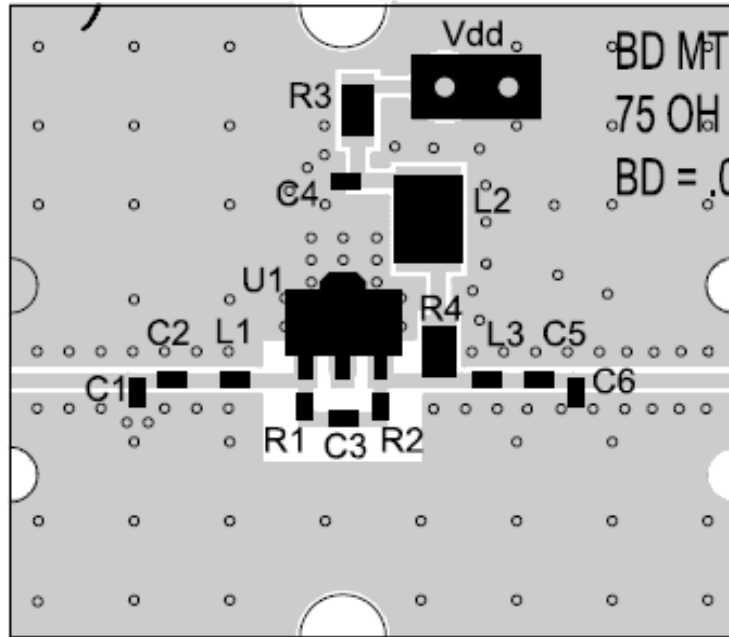

Recommended PCB Layout—Bottom Side Metal Layer (Viewed from Bottom)

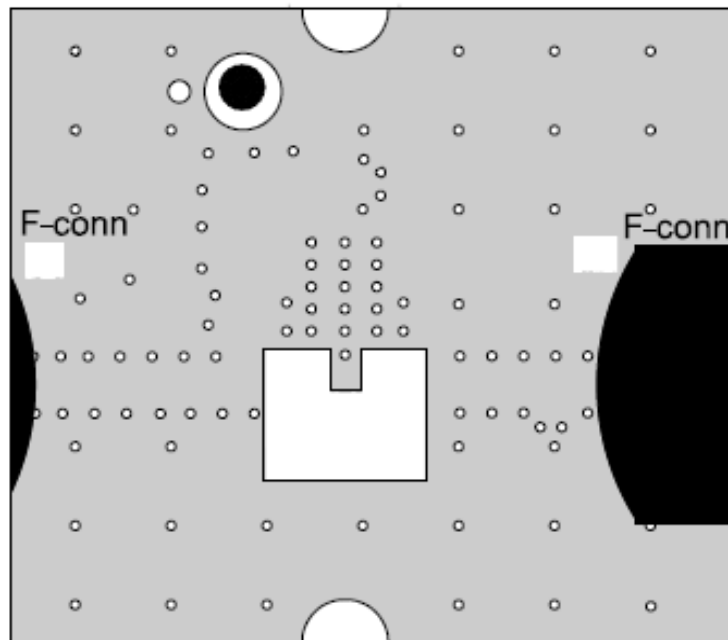

Typical Performance Curves:

Gain to 1000 MHz

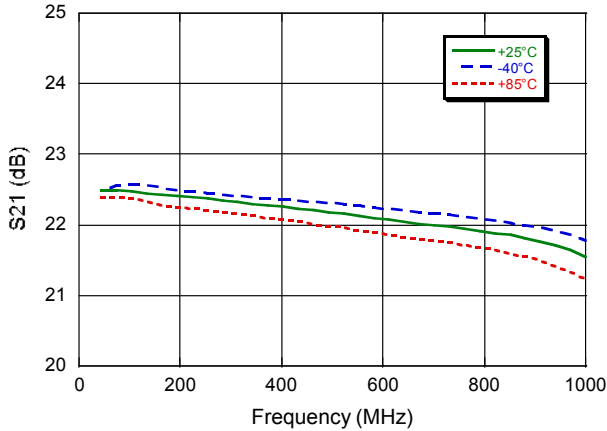

Gain to 3000 MHz

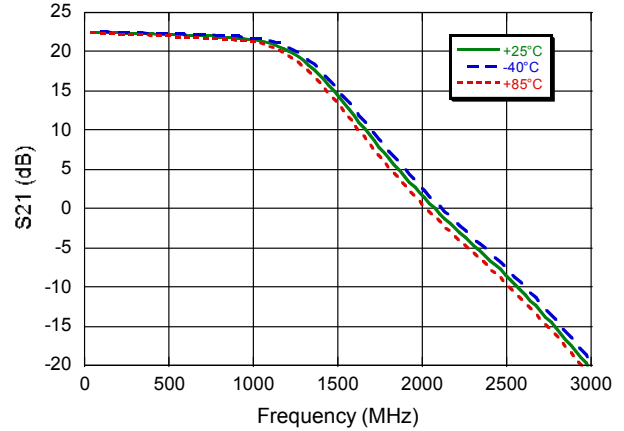

Input Return Loss

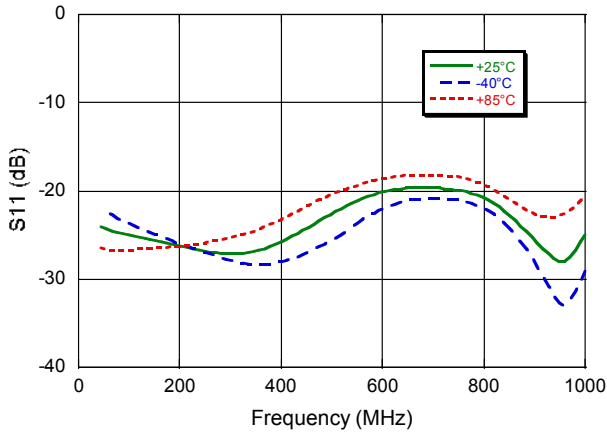

Output Return Loss

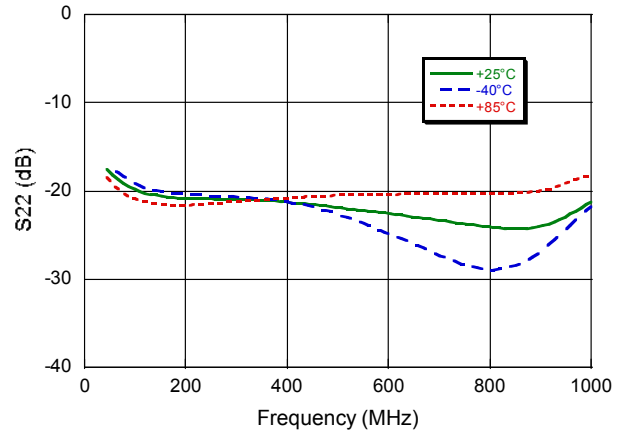

Noise Figure

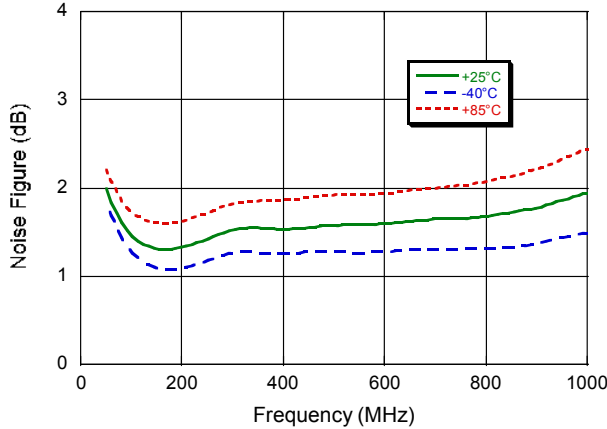

Reverse Isolation

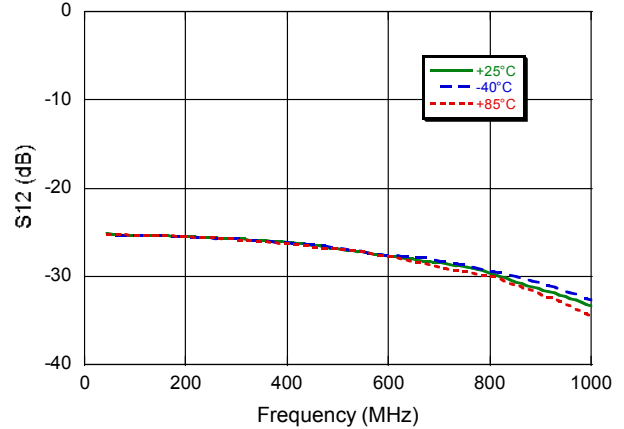

ADVANCED: Data Sheets contain information regarding a product M/A-COM Technology Solutions is considering for development. Performance is based on target specifications, simulated results, and/or prototype measurements. Commitment to develop is not guaranteed.
PRELIMINARY: Data Sheets contain information regarding a product M/A-COM Technology Solutions has under development. Performance is based on engineering tests. Specifications are typical. Mechanical outline has been fixed. Engineering samples and/or test data may be available. Commitment to produce in volume is not guaranteed.

• **North America** Tel: 800.366.2266 • **Europe** Tel: +353.21.244.6400
 • **India** Tel: +91.80.43537383 • **China** Tel: +86.21.2407.1588
 Visit www.macontech.com for additional data sheets and product information.

M/A-COM Technology Solutions Inc. and its affiliates reserve the right to make changes to the product(s) or information contained herein without notice.

Lead-Free SOT-89 Plastic Package[†]

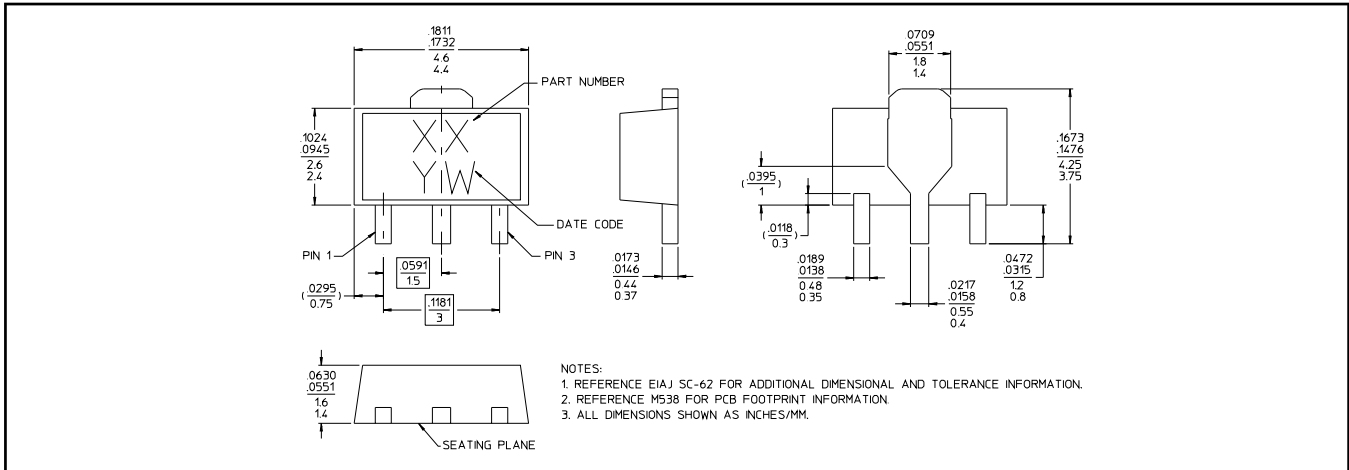

[†] Reference Application Note M538 for lead-free solder reflow recommendations.
Meets JEDEC moisture sensitivity level 1 requirements.
Plating is 100% matte tin over copper.

Handling Procedures

Please observe the following precautions to avoid damage:

Static Sensitivity

Gallium Arsenide Integrated Circuits are sensitive to electrostatic discharge (ESD) and can be damaged by static electricity. Proper ESD control techniques should be used when handling these devices.