

## Features

- Attenuation: 0.5 dB Steps to 31.5 dB
- Low DC Power Consumption
- Plastic SOIC, Wide Body, SMT Package
- Integral TTL Driver
- 50 ohm Impedance
- Test Boards are Available
- Tape and Reel Packaging Available
- Lead-Free SOW-24 Package
- 100% Matte Tin Plating over Copper
- Halogen-Free "Green" Mold Compound
- 260°C Reflow Compatible
- RoHS\* Compliant Version of AT65-0107

## Description

M/A-COM's MAATCC0005 is a GaAs FET 6-bit digital attenuator with a 0.5 dB minimum step size and a 31.5 dB total attenuation range. This device is in a SOIC-24 wide body, plastic surface mount package. The MAATCC0005 is ideally suited for use where accuracy, fast speed, very low power consumption and low costs are required.

## Ordering Information

Part Number	Package
MAATCC0005	Bulk Packaging
MAATCC0005TR	1000 piece reel
MAATCC0005-TB	Sample Test Board

Note: Reference Application Note M513 for reel size information.

## Schematic with Off-Chip Components

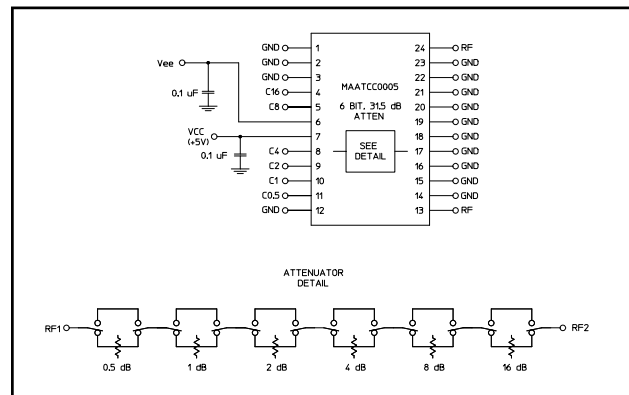

## Pin Configuration

Pin No.	Function	Pin No.	Function
1	GND	13	RF
2	GND	14	GND
3	GND	15	GND
4	C16	16	GND
5	C8	17	GND
6	Vee	18	GND
7	Vcc	19	GND
8	C4	20	GND
9	C2	21	GND
10	C1	22	GND
11	C0.5	23	GND
12	GND	24	RF

\* Restrictions on Hazardous Substances, European Union Directive 2002/95/EC.

## Electrical Specifications: $T_A = 25^\circ\text{C}$

Parameter	Test Conditions	Frequency	Units	Min	Typ	Max
Insertion Loss	—	DC - 1.0 GHz	dB	—	3.1	3.6
		DC - 2.0 GHz	dB	—	3.6	4.2
Attenuation Accuracy	Any Bit or Combination of Bits	DC - 2.0 GHz	dB	—	—	$\pm(0.3 + 4\% \text{ of atten.})$
VSWR	Full Range	DC - 2.0 GHz	Ratio	—	1.8:1	2:1
Switching Speed	50% Cntl to 90%/10% RF 10% to 90% or 90% to 10%	—	nS	—	75	150
		—	nS	—	20	50
1 dB Compression	—	50 MHz 0.5 - 2.0 GHz	dBm	—	+21	—
			dBm	—	+29	—
Input IP <sub>3</sub>	Two-tone inputs up to +5 dBm	50 MHz 0.5-2.0 GHz	dB	—	+35	—
			dB	—	+48	—
V <sub>CC</sub> <sup>1</sup>	—	—	V	4.75	5.0	5.25
V <sub>EE</sub> <sup>1</sup>	—	—	V	-8.0	-5.0	-4.75
V <sub>IL</sub> V <sub>IH</sub>	LOW-level input voltage HIGH-level input voltage	—	V	0.0	—	0.8
		—	V	2.0	—	5.0
I <sub>in</sub> (Input Leakage Current)	V <sub>in</sub> = V <sub>CC</sub> or GND	—	uA	-1.0	—	1.0
I <sub>CC</sub> (Quiescent Supply Current)	V <sub>cntrl</sub> = V <sub>CC</sub> or GND	—	uA	—	250	400
$\Delta$ I <sub>CC</sub> (Additional Supply Current Per TTL Input Pin)	V <sub>CC</sub> = Max, V <sub>cntrl</sub> = V <sub>CC</sub> - 2.1 V	—	mA	—	—	1.0
I <sub>EE</sub>	V <sub>EE</sub> min to max, V <sub>in</sub> = V <sub>IL</sub> or V <sub>IH</sub>	—	mA	-1.0	-0.2	—

1. Decoupling capacitors (.1  $\mu\text{F}$ ) are required on Power Supply lines.

## Absolute Maximum Ratings<sup>2,3</sup>

Parameter	Absolute Maximum
Max. Input Power 0.05 GHz 0.5 - 2.0 GHz	+27 dBm +34 dBm
V <sub>CC</sub>	$-0.5\text{V} \leq V_{CC} \leq +7.0\text{V}$
V <sub>EE</sub>	$-8.5\text{V} \leq V_{EE} \leq +0.5\text{V}$
V <sub>CC</sub> - V <sub>EE</sub>	$-0.5\text{V} \leq V_{CC} - V_{EE} \leq 14.5\text{V}$
V <sub>in</sub> <sup>4</sup>	$-0.5\text{V} \leq V_{in} \leq V_{CC} + 0.5\text{V}$
Operating Temperature	-40°C to +85°C
Storage Temperature	-65°C to +125°C

- Exceeding any one or combination of these limits may cause permanent damage to this device.
- M/A-COM does not recommend sustained operation near these survivability limits.
- Standard CMOS TTL interface, latch-up will occur if logic signal is applied prior to power supply.

## Handling Procedures

Please observe the following precautions to avoid damage:

## Static Sensitivity

Gallium Arsenide Integrated Circuits are sensitive to electrostatic discharge (ESD) and can be damaged by static electricity. Proper ESD control techniques should be used when handling these devices.

## Truth Table (Digital Attenuator)

C16	C8	C4	C2	C1	C0.5	Attenuation
0	0	0	0	0	0	Loss. Reference
0	0	0	0	0	1	0.5 dB
0	0	0	0	1	0	1.0 dB
0	0	0	1	0	0	2.0 dB
0	0	1	0	0	0	4.0 dB
0	1	0	0	0	0	8.0 dB
1	0	0	0	0	0	16.0 dB
1	1	1	1	1	1	31.5 dB

0 = TTL Low; 1 = TTL High

## Typical Performance Curves

### Loss vs. Temperature

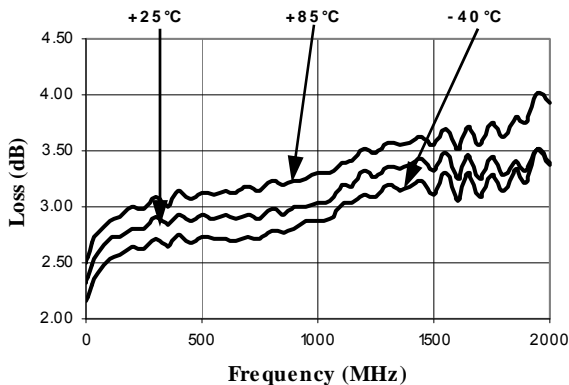

### 0.5 dB Bit vs. Temperature

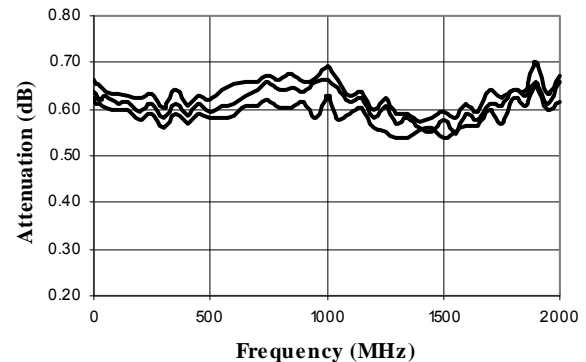

### 1 dB Bit vs. Temperature

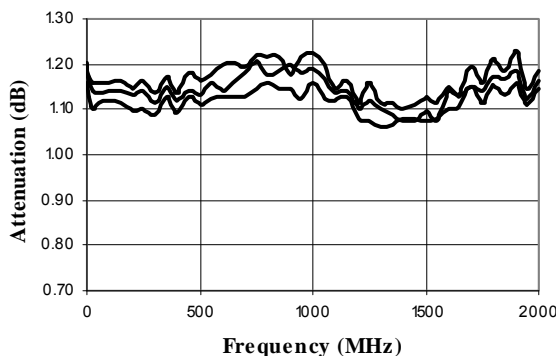

### 2 dB Bit vs. Temperature

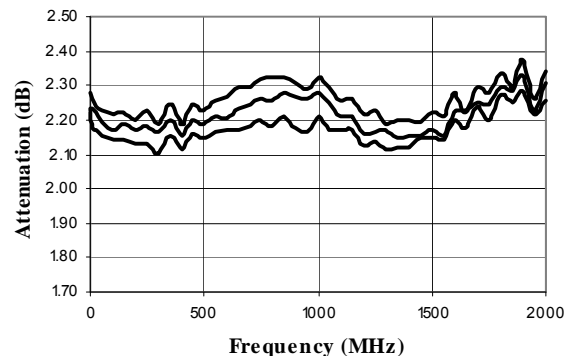

## Typical Performance Curves

4 dB Bit vs. Temperature

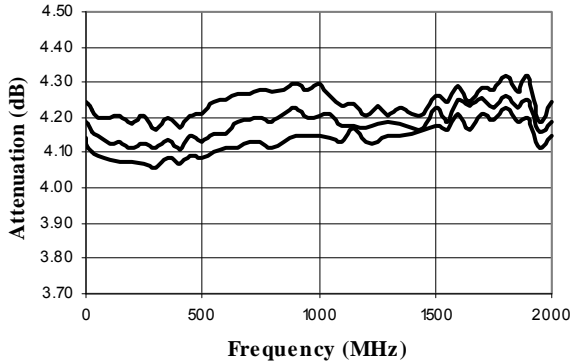

8 dB Bit vs. Temperature

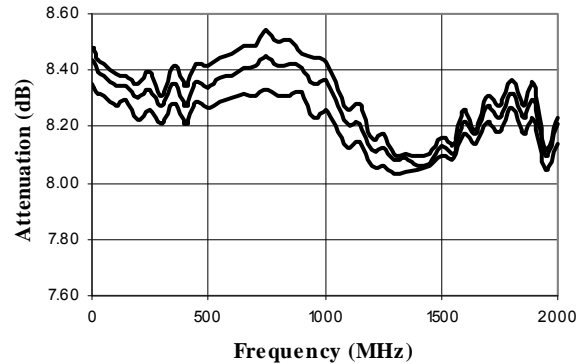

16 dB Bit vs. Temperature

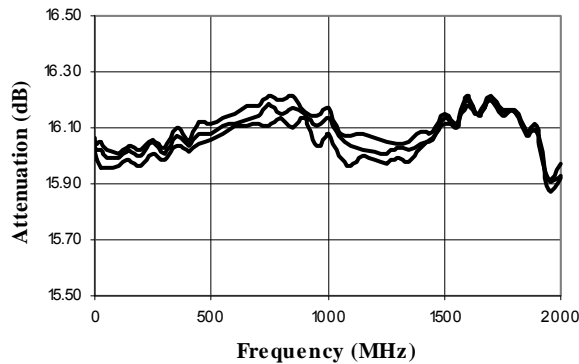

Max Attenuation vs. Temperature

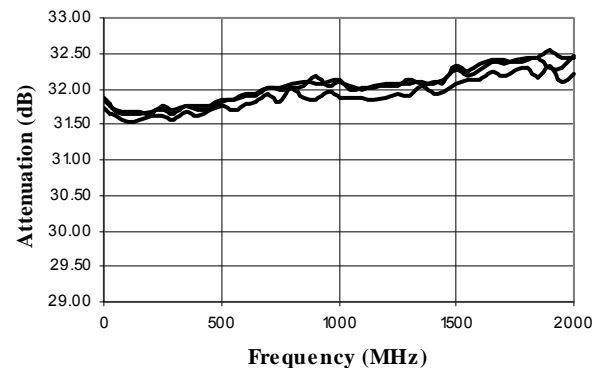

VSWR @ Insertion Loss

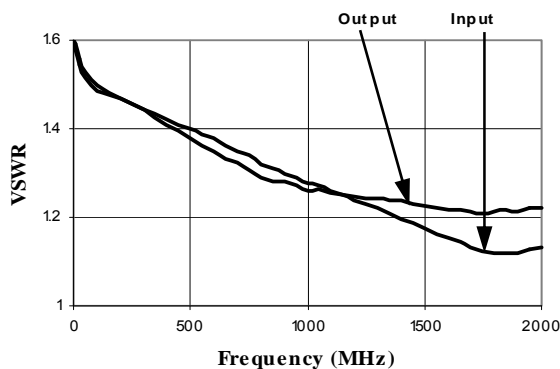

VSWR, 0.5 dB Bit

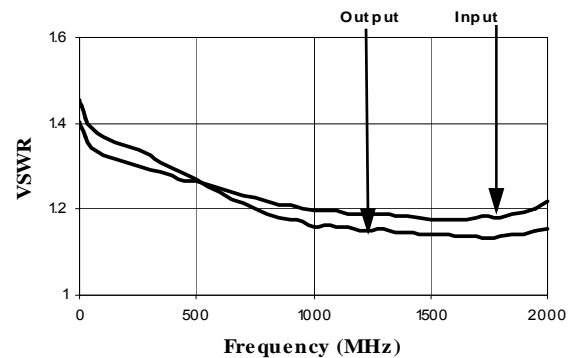

## Typical Performance Curves

VSWR, 1 dB Bit

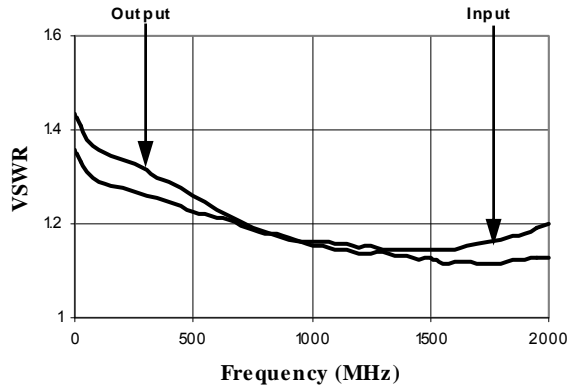

VSWR, 2 dB Bit

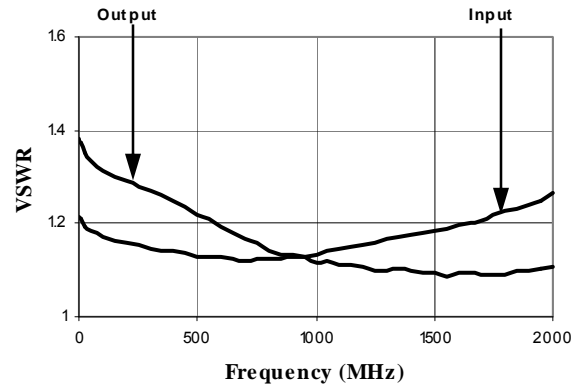

VSWR, 4 dB Bit

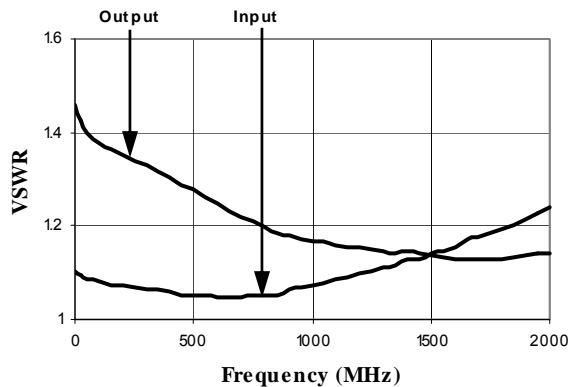

VSWR, 8 dB Bit

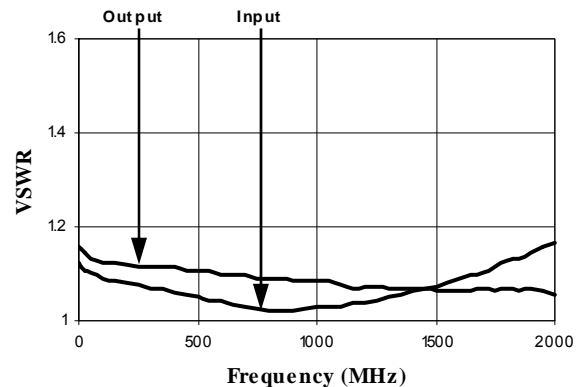

VSWR, 16 dB Bit

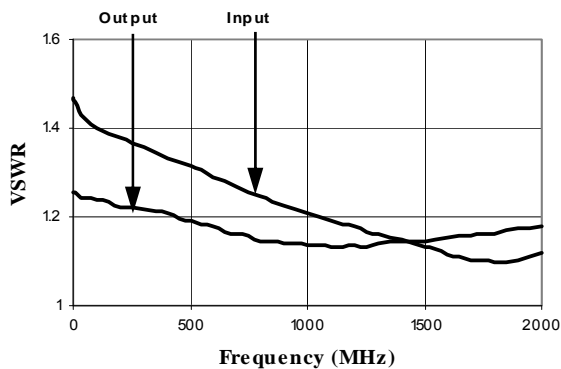

VSWR, Maximum Attenuation

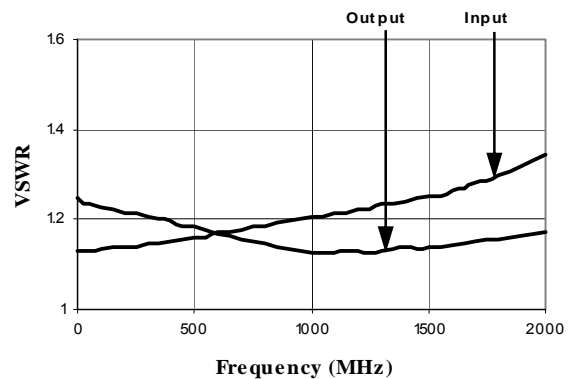

## Lead-Free, SOW-24<sup>†</sup>

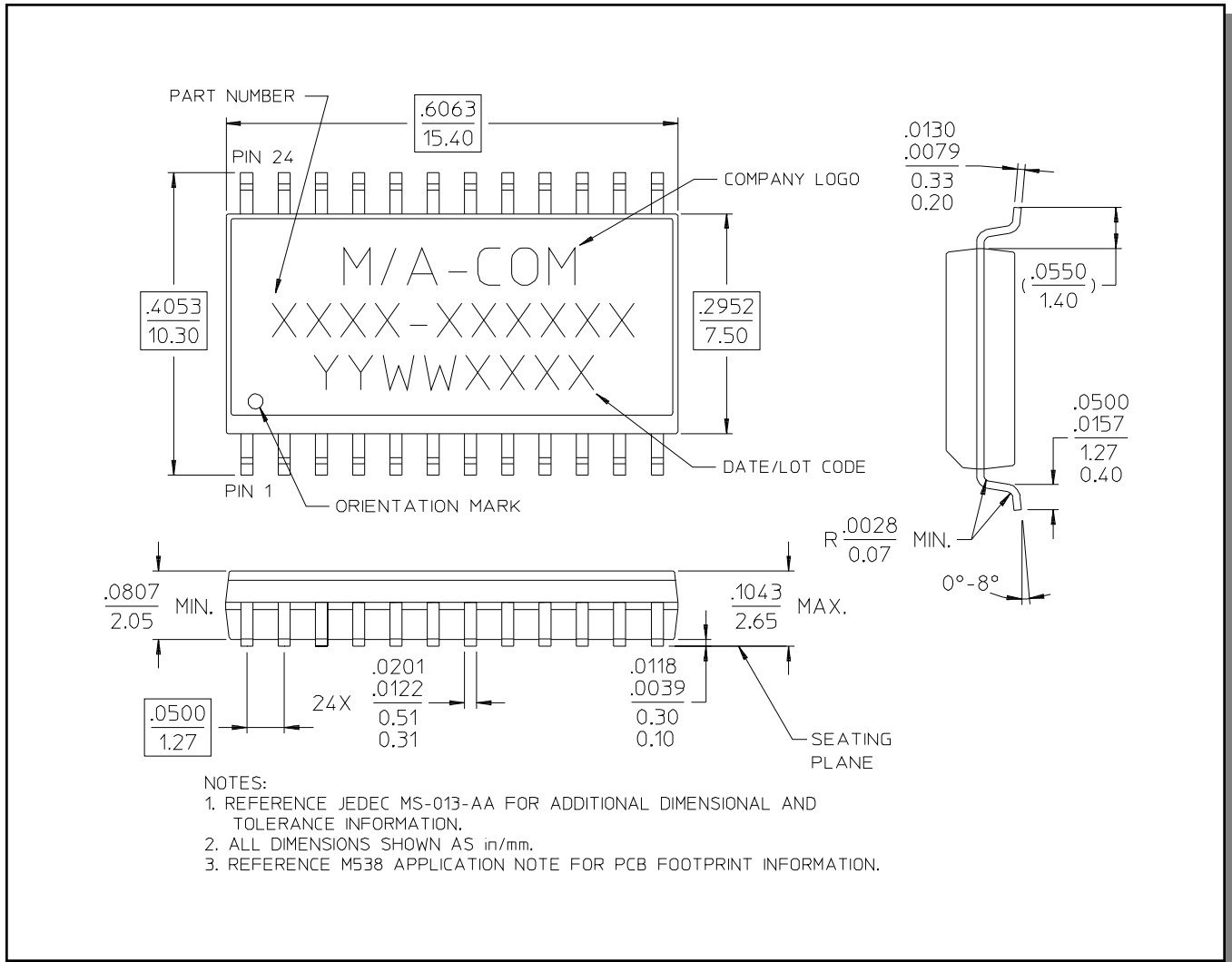

<sup>†</sup> Reference Application Note M538 for lead-free solder reflow recommendations.