

Features

- Attenuation: 1.0 dB Steps to 31 dB
- Low DC Power Consumption
- Small Footprint, JEDEC Package
- Integral TTL Driver
- 50 ohm Impedance
- Test Boards are Available
- Tape and Reel Packaging Available
- Lead-Free CSP-1 Package
- 100% Matte Tin Plating over Copper
- Halogen-Free "Green" Mold Compound
- 260°C Reflow Compatible
- RoHS* Compliant Version of AT90-0263

Description

M/A-COM's MAATCC0010 is a GaAs FET 5-bit digital attenuator with integral TTL driver. Step size is 1.0 dB providing 31 dB total attenuation range. This device is in a PQFN plastic surface mount package. The MAATCC0010 is ideally suited for use where accuracy, fast speed, very low power consumption and low costs are required.

Block Diagram

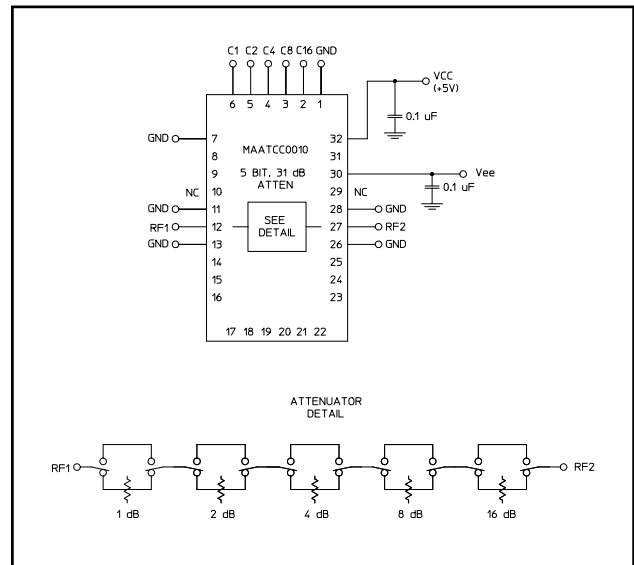

Pin Configuration²

Pin No.	Function	Pin No.	Function
1	GND	17	NC
2	C16	18	NC
3	C8	19	NC
4	C4	20	NC
5	C2	21	NC
6	C1	22	NC
7	GND	23	NC
8	NC	24	NC
9	NC	25	NC
10	NC ³	26	GND
11	GND	27	RF2
12	RF1	28	GND
13	GND	29	NC ¹
14	NC	30	Vee
15	NC	31	NC
16	NC	32	+Vcc

1. Pins 10 & 29 must be isolated
2. The exposed pad centered on the package bottom must be connected to RF and DC ground. (For PQFN Packages)

Ordering Information

Part Number	Package
MAATCC0010	Bulk Packaging
MAATCC0010TR	1000 piece reel
MAATCC0010-TB	Sample Test Board

Note: Reference Application Note M513 for reel size information.

* Restrictions on Hazardous Substances, European Union Directive 2002/95/EC.

Digital Attenuator 31.0 dB, 5-Bit, TTL Driver, DC-3.0 GHz

Rev. V5

Electrical Specifications: $T_A = +25^\circ\text{C}$

Parameter	Test Conditions	Frequency	Units	Min	Typ	Max
Insertion Loss	—	DC - 3.0 GHz	dB	—	3.6	4.0
Attenuation Accuracy	Individual Bits 1-2-4-8-16 dB Any Combination of Bits 1 to 31 dB	DC - 3.0 GHz	dB	—	—	$\pm(.3 +5\%$ of atten setting)
		DC - 3.0 GHz	dB	—	—	$\pm(.5 +7\%$ of atten setting)
VSWR	Full Range	DC - 3.0 GHz	Ratio	—	2.0:1	2.2:1
Switching Speed	50% Cntl to 90%/10% RF 10% to 90% or 90% to 10%	—	ns	—	75	150
		—	ns	—	20	50
1 dB Compression	—	50 MHz	dBm	—	+21	—
		0.5 - 3.0 GHz	dBm	—	+24	—
Input IP_3	Two-tone inputs up to +5 dBm	50 MHz	dB	—	+35	—
		0.5 - 3.0 GHz	dB	—	+48	—
V_{CC}	—	—	V	4.75	5.0	5.25
V_{EE}	—	—	V	-8.0	-5.0	-4.75
V_{IL}	LOW-level input voltage HIGH-level input voltage	—	V	0.0	—	0.8
V_{IH}		—	V	2.0	—	5.0
I_{in} (Input Leakage Current)	$V_{in} = V_{CC}$ or GND	—	μA	-1.0	—	1.0
I_{CC} (Quiescent Supply Current)	$V_{cntrl} = V_{CC}$ or GND	—	μA	—	250	400
ΔI_{CC} (Additional Supply Current Per TTL Input Pin)	$V_{CC} = \text{Max}$, $V_{cntrl} = V_{CC} - 2.1 \text{ V}$	—	mA	—	—	1.0
IEE	V_{EE} min to max, $V_{in} = V_{IL}$ or V_{IH}	—	mA	-1.0	-0.2	—
Thermal Resistance θ_{jc}	—	—	$^\circ\text{C/W}$	—	35	—

Absolute Maximum Ratings^{3,4}

Parameter	Absolute Maximum
Max. Input Power 0.05 GHz 0.5 - 3.0 GHz	+27 dBm +34 dBm
V_{CC}	$-0.5\text{V} \leq V_{CC} \leq +7.0\text{V}$
V_{EE}	$-8.5\text{V} \leq V_{EE} \leq +0.5\text{V}$
$V_{CC} - V_{EE}$	$-0.5\text{V} \leq V_{CC} - V_{EE} \leq 14.5\text{V}$
V_{in}^5	$-0.5\text{V} \leq V_{in} \leq V_{CC} + 0.5\text{V}$
Operating Temperature	-40°C to $+85^\circ\text{C}$
Storage Temperature	-65°C to $+125^\circ\text{C}$

- Exceeding any one or combination of these limits may cause permanent damage to this device.
- M/A-COM does not recommend sustained operation near these survivability limits.
- Standard CMOS TTL interface, latch-up will occur if logic signal is applied prior to power supply.

Recommended PCB Configuration⁶

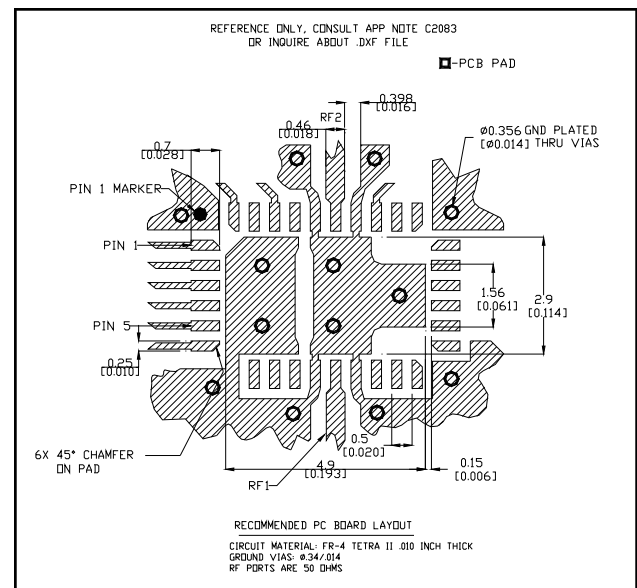

- Application Note S2083 is available on line at www.macom.com

Handling Procedures

Please observe the following precautions to avoid damage:

Static Sensitivity

Gallium Arsenide Integrated Circuits are sensitive to electrostatic discharge (ESD) and can be damaged by static electricity. Proper ESD control techniques should be used when handling these devices.

Moisture Sensitivity

The MSL rating for this part is defined as Level 2 per IPC/JEDEC J-STD-020. Parts shall be stored and/or baked as required for MSL Level 2 parts.

Truth Table (Digital Attenuator)

C16	C8	C4	C2	C1	Attenuation
0	0	0	0	0	Loss, Reference
0	0	0	0	1	1.0 dB
0	0	0	1	0	2.0 dB
0	0	1	0	0	4.0 dB
0	1	0	0	0	8.0 dB
1	0	0	0	0	16.0 dB
1	1	1	1	1	31.0 dB

0 = TTL Low; 1 = TTL High

Typical Performance Curves

Insertion Loss

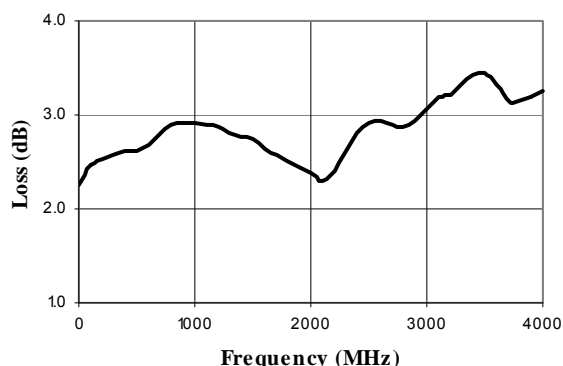

VSWR @ Insertion Loss

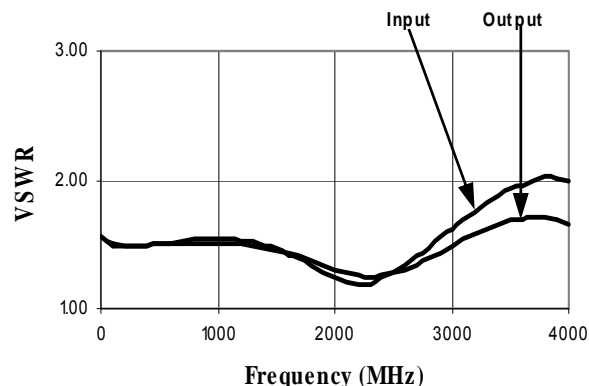

Attenuation Error, 1 dB Bit

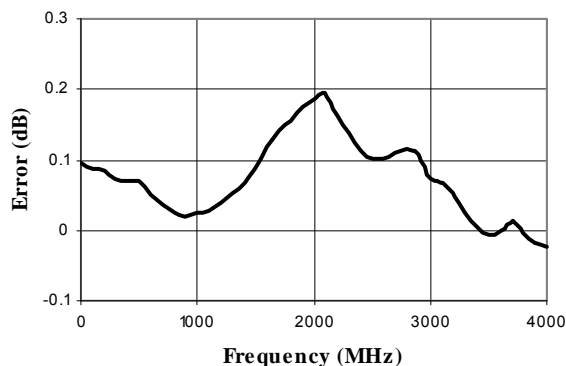

Attenuation Error, 2 dB Bit

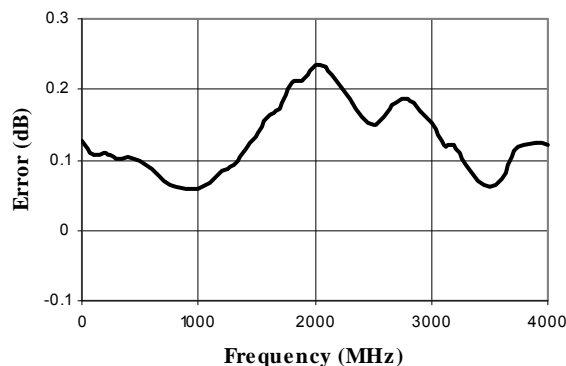

Typical Performance Curves

Attenuation Error, 4 dB Bit

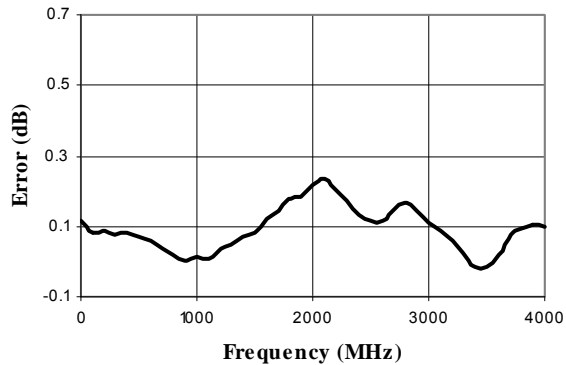

Attenuation Error, 8 dB Bit

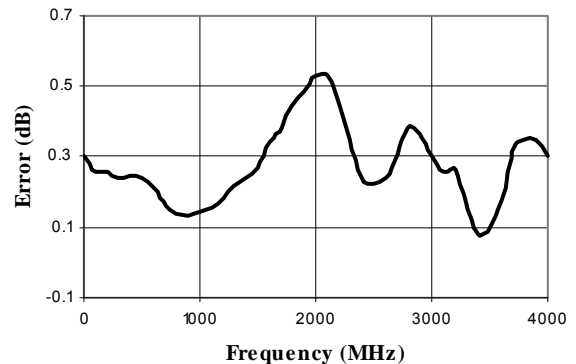

Attenuation Error, 16 dB Bit

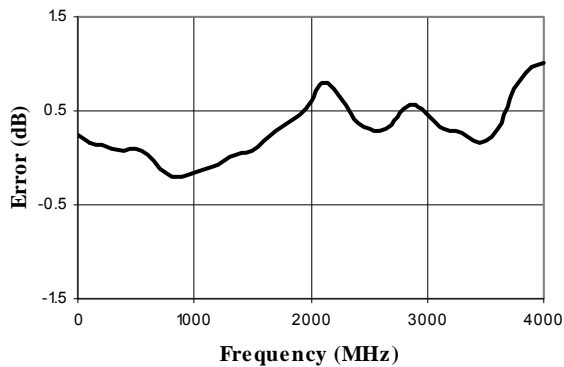

Attenuation Error, Max. Attenuation

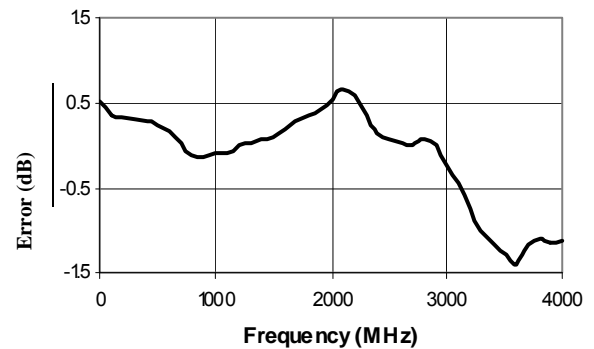

VSWR, 1 dB Bit

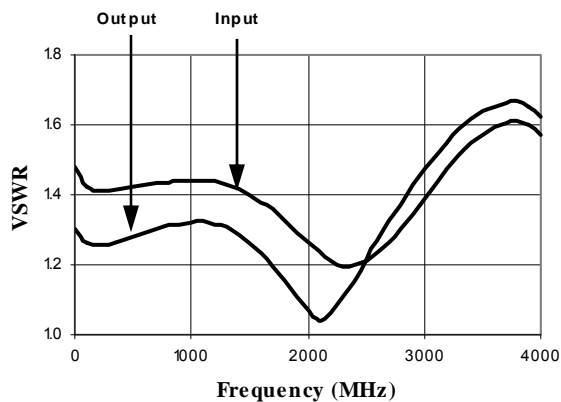

VSWR, 2 dB Bit

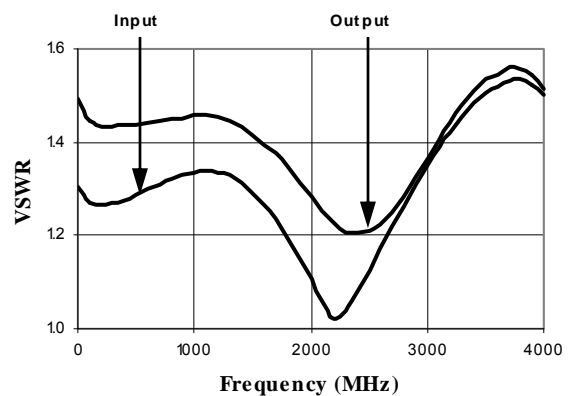

Typical Performance Curves

VSWR, 4 dB Bit

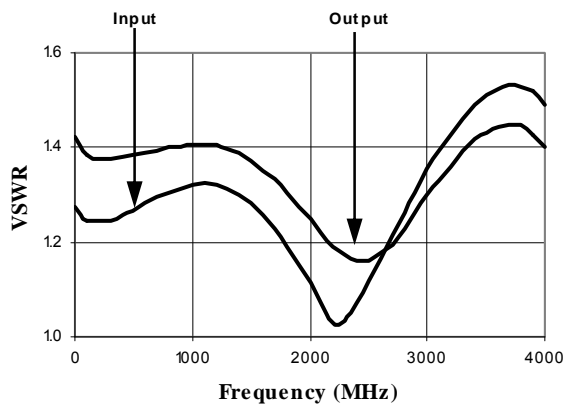

VSWR, 8 dB Bit

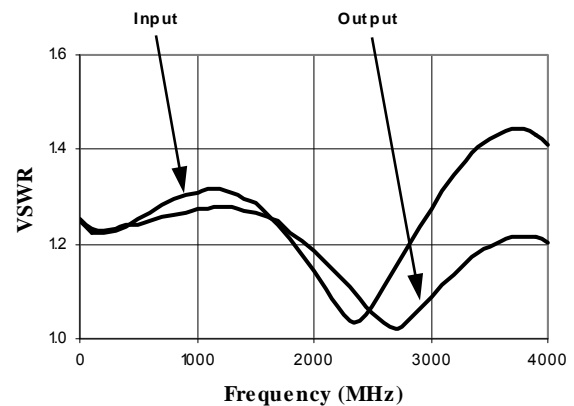

VSWR, 16 dB Bit

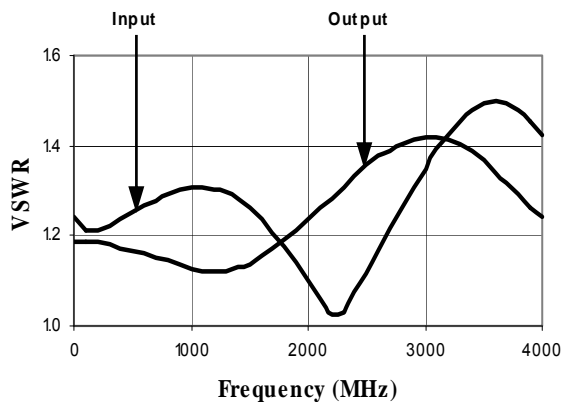

VSWR, Maximum Attenuation

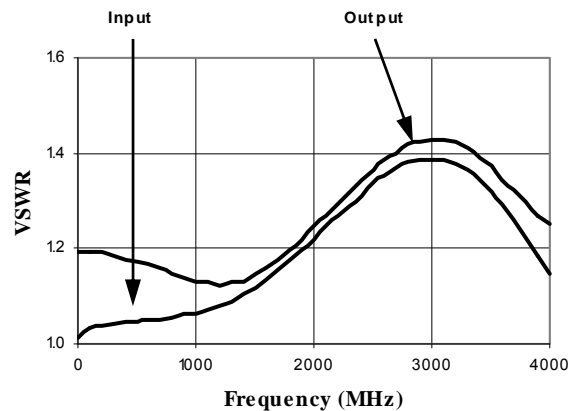

Digital Attenuator
31.0 dB, 5-Bit, TTL Driver, DC-3.0 GHz

Rev. V5

CSP-1, Lead-Free 4 x 6 mm, 32-lead PQFN†

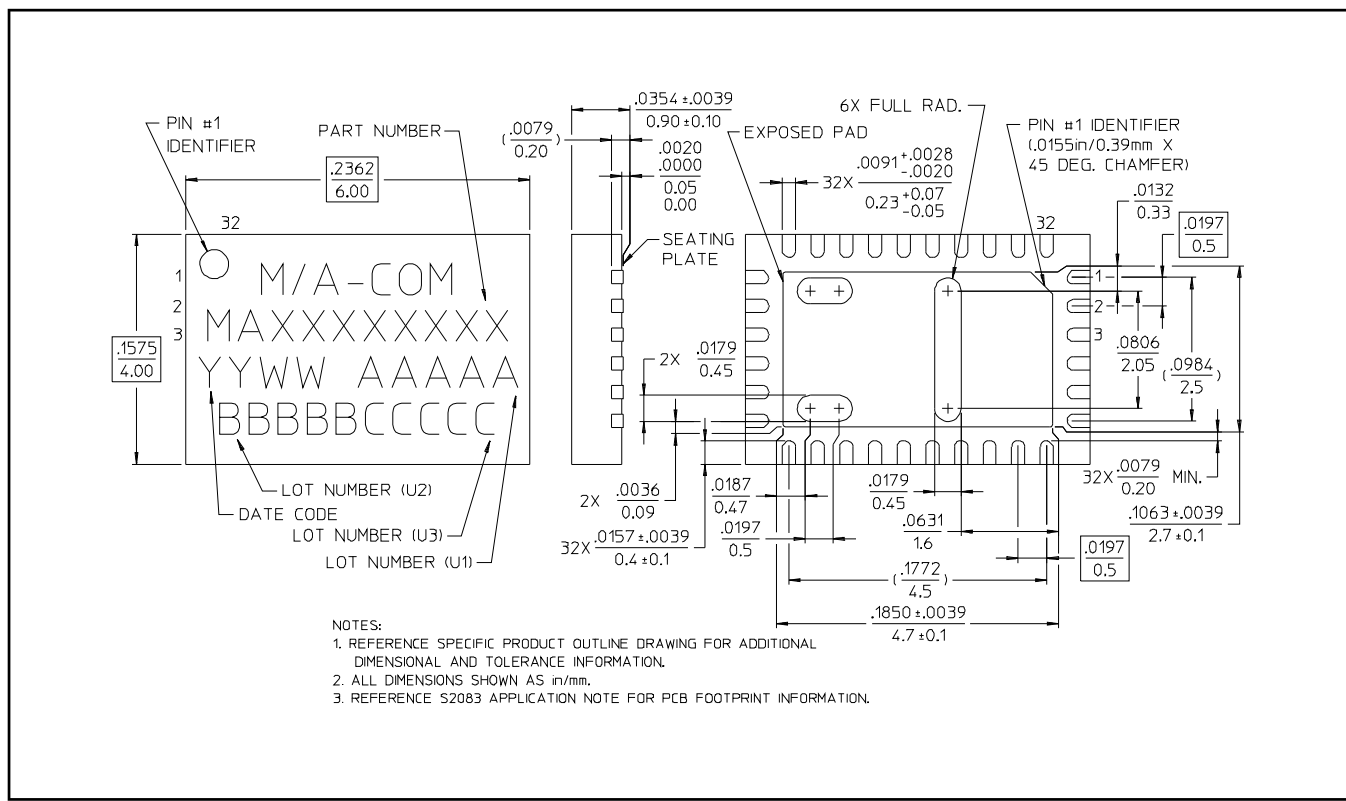

† Reference Application Note M538 for lead-free solder reflow recommendations.