

Features

- 25 dB Attenuation Range
- High IP3
- Excellent Linearity Performance
- Low Cost/High Performance
- 50 Ohm Nominal Impedance
- Lead-Free SOT-25 Package
- 100% Matte Tin Plating over Copper
- Halogen-Free "Green" Mold Compound
- 260°C Reflow Compatible
- RoHS* Compliant Version of AT65-0009

Description

M/A-COM's MAATCC0013 is an integrated voltage variable attenuator containing two PIN diodes and a passive glass quadrature hybrid. This device is packaged in a 5 leaded SOT plastic surface mount package. Maximum attenuation is typically achieved at 3.5 V bias using the suggested bias circuit. The MAATCC0013 is ideally suited for GSM communication applications requiring variable attenuation in the 824 to 960 MHz bandwidth.

Ordering Information

Part Number	Package
MAATCC0013	Bulk Packaging
MAATCC0013TR	1000 piece reel
MAATCC0013-TB	Sample Test Board

Note: Reference Application Note M513 for reel size information.

* Restrictions on Hazardous Substances, European Union Directive 2002/95/EC.

Functional Diagram and Bias Circuitry

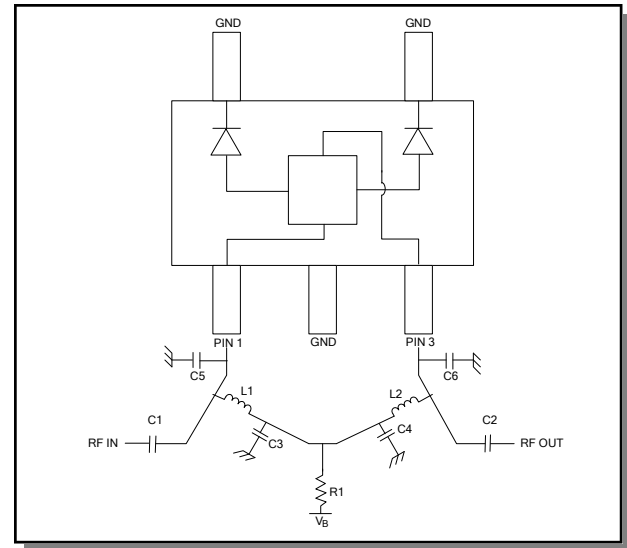

Pin Configuration

Pin No.	Function
1	RFIN, V _B
2	GND
3	RFOUT, V _B
4	GND
5	GND

External Circuitry Parts ¹

Part	Value	Purpose
C1	390 pF	DC Block
C2	390 pF	DC Block
C3	390 pF	By-pass
C4	390 pF	By-pass
L1	180 nH	RF Choke
L2	180 nH	RF Choke
R1	10 KOhm	Current Limiting
C5 ²	1.5 pF	RF Tune
C6 ²	1.5 pF	RF Tune

1. All external circuitry parts are readily available, low cost surface mount components (.060 in. x .030 in. or .080 in. x .050 in.).
2. See Application Note MA-C-05010008A for external tuning capacitor values to suit specific Communication Bandwidths. Insertion Loss will vary depending on tuning capacitor value chosen.

Electrical Specifications: $T_A = 25^\circ\text{C}$, $Z_0 = 50\Omega$, $F = 824$ to 960 MHz

Parameter	Test Conditions	Units	Min	Typ	Max
Insertion Loss	$V_B = 0$ V	dB	—	1.7	2.1
VSWR		Ratio	—	1.7	2.2
Attenuation Flatness vs. Frequency	0 - 10 dB	dB	—	1.3	—
	0 - 20 dB	dB	—	1.3	—
	0 - 30 dB	dB	—	2.5	—
Switching Speed	50% control to 90%/10% RF	usec	—	7.0	—
Input IP3	Two Tones 900 MHz, 905 MHz, +5 dBm $V_B = 0$ V	dBm	—	40	—
Input IP2	Two Tones 900 MHz, 905 MHz, +5 dBm $V_B = 0$ V	dBm	—	34	—
Attenuation	$I_B = 0.30$ to 0.45 mA	dB	25	28	—

Absolute Maximum Ratings ^{3,4}

Parameter	Absolute Maximum
Max Input Power	+27 dBm
Operating Voltage	+5 V
Operating Temperature	-40°C to +85°C
Storage Temperature	-65°C to +125°C

- Exceeding any one or combination of these limits may cause permanent damage to this device.
- M/A-COM does not recommend sustained operation near these survivability limits.

Handling Procedures

Please observe the following precautions to avoid damage:

Static Sensitivity

GMIC Circuits are sensitive to electrostatic discharge (ESD) and can be damaged by static electricity. Proper ESD control techniques should be used when handling these devices.

Recommended PCB Configuration ⁵

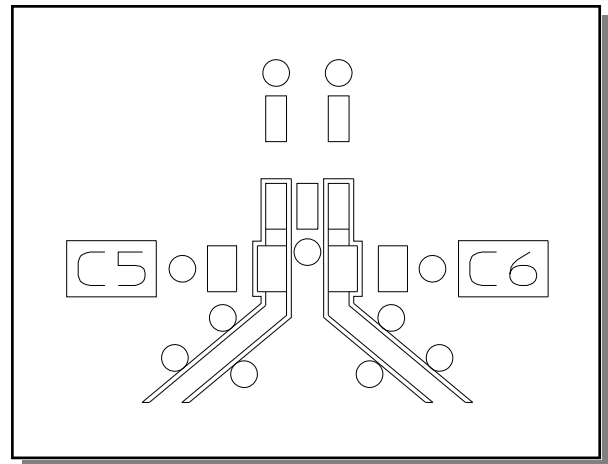

- Circuit Material = FR-406, 0.031 inches thick.
Line Width = 0.025 inches, Line Spacing = 0.0056 inches.

Typical Performance Curves

Attenuation vs. Voltage with 1.5 pF Tuning Cap @ +25°C

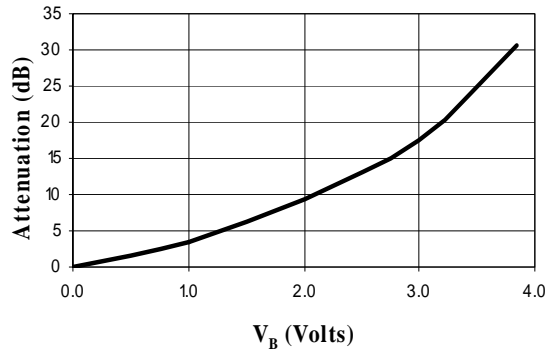

Attenuation vs. Freq. With 1.5 pF Tuning Cap @ +25°C

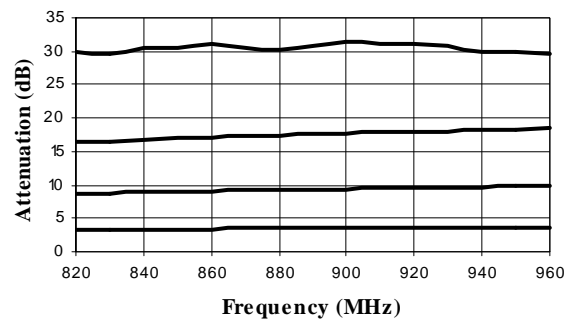

Attenuation vs. Voltage with 1.5 pF Tuning Cap @ +85°C

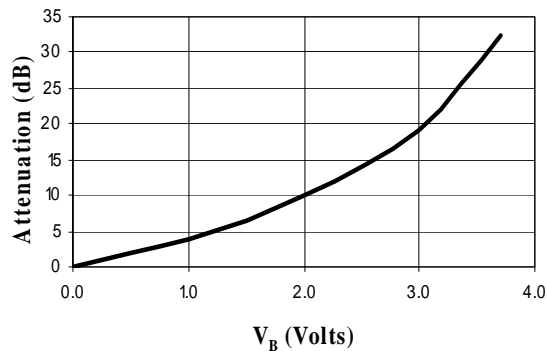

Attenuation vs. Freq. With 1.5 pF Tuning Cap @ +85°C

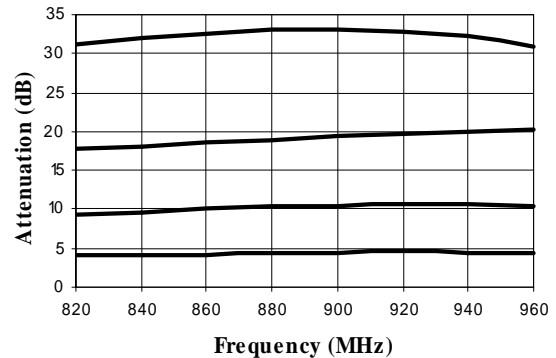

Attenuation vs. Voltage with 1.5 pF Tuning Cap @ -40°C

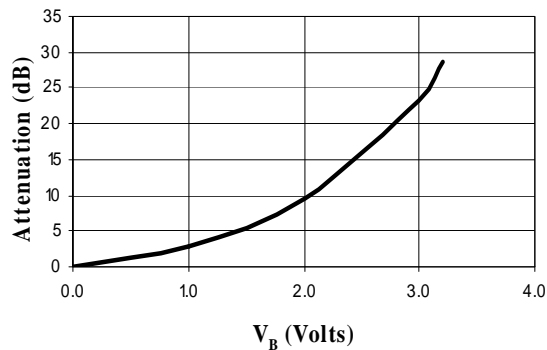

Attenuation vs. Freq. With 1.5 pF Tuning Cap @ -40°C

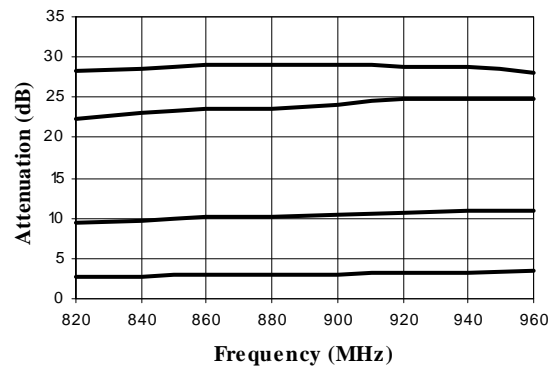

Typical Performance Curves

VSWR vs. Freq. With 1.5 pF Tuning Cap @ +25°C

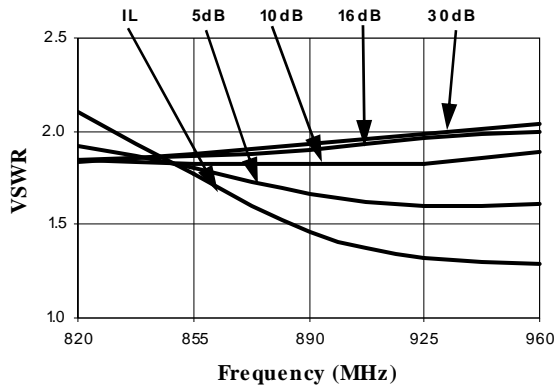

Loss vs. Frequency @ +25°C
No Tuning Cap (See Note 2)

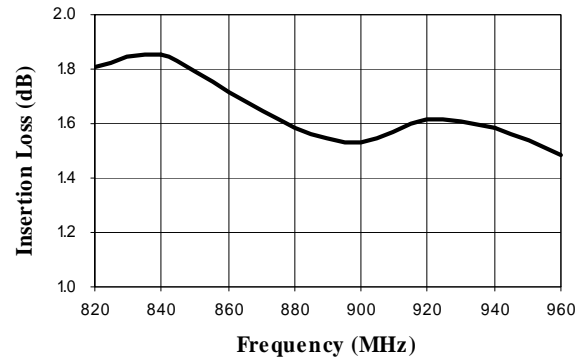

VSWR vs. Freq. With 1.5 pF Tuning Cap @ +85°C

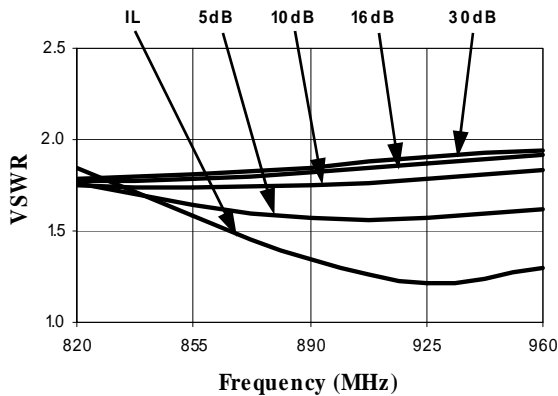

Loss vs. Frequency @ +85°C
No Tuning Cap (See Note 2)

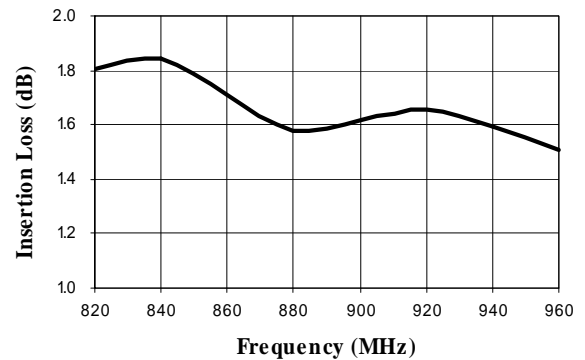

VSWR vs. Freq. With 1.5 pF Tuning Cap @ -40°C

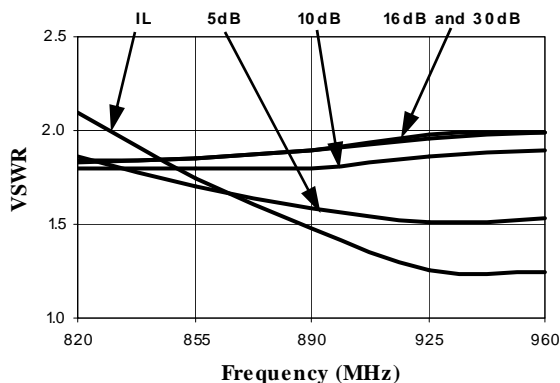

Loss vs. Frequency @ -40°C
No Tuning Cap (See Note 2)

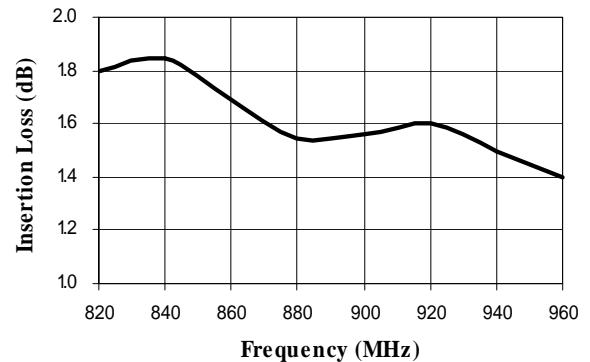

Lead-Free, SOT-25[†]

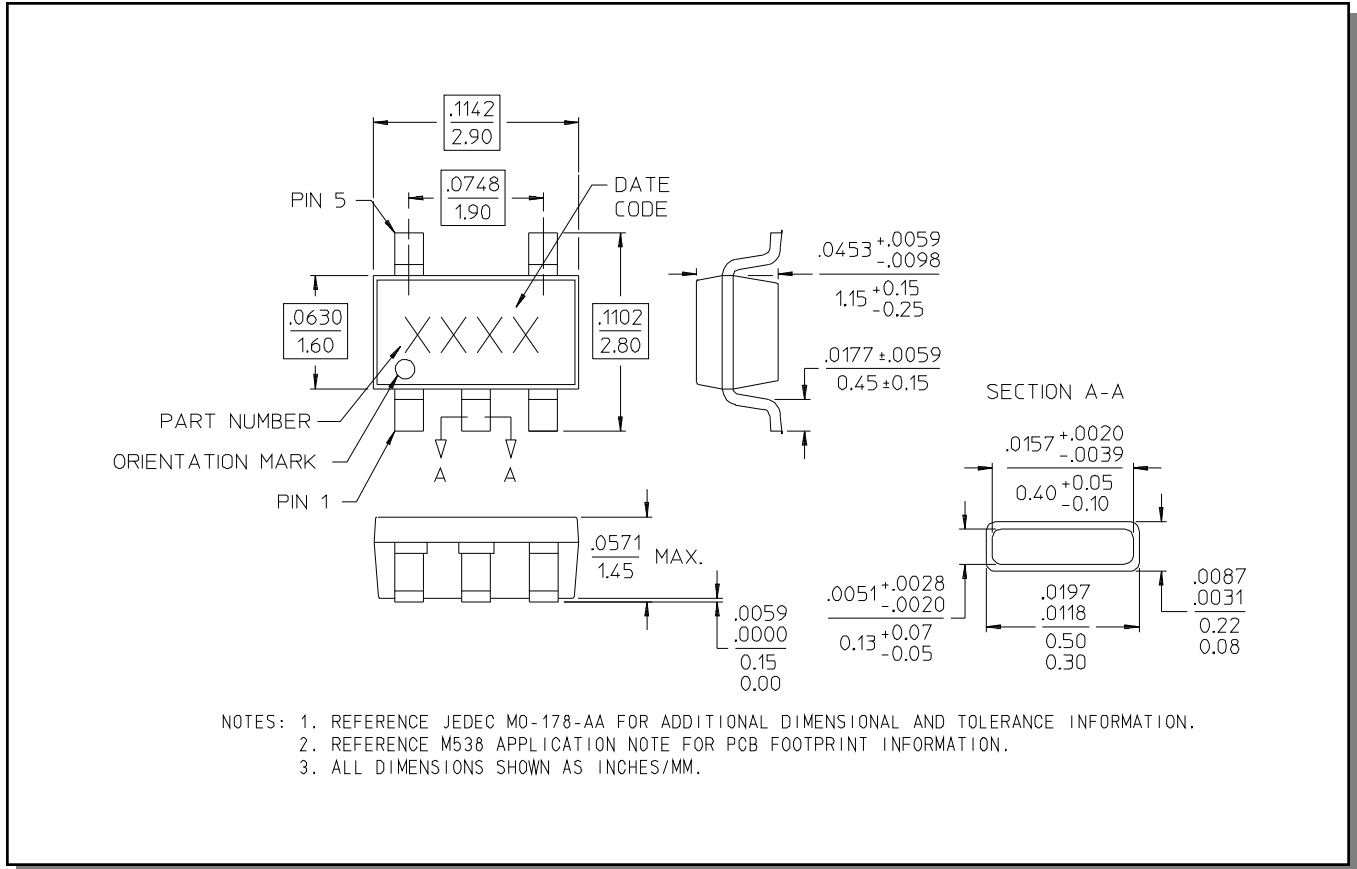

[†] Reference Application Note M538 for lead-free solder reflow recommendations.