

MABA-009180-500MHZ



E-Series RF 1:1 Transformer
0.4-500 MHz

MABA-009180-500MHZ
V2

Features

- Surface Mount
- 1:1 Impedance Ratio
- CT on Secondary
- RoHS* Compliant 1:1 transformer
- Tape and reel packaging available

Description

M/A-COM's MABA-009180-500MHZ is a RoHS compliant 1:1 RF flux coupled transformer in a low cost, surface mount package. Ideally suited for high volume cellular and wireless applications. Typical applications include single to balanced mode conversion and impedance matching. The MABA-009180-500MHZ transformer is offered in an SM-22 surface mount package and is designed to be utilized in both standard reflow and high temperature soldering reflow profiles.

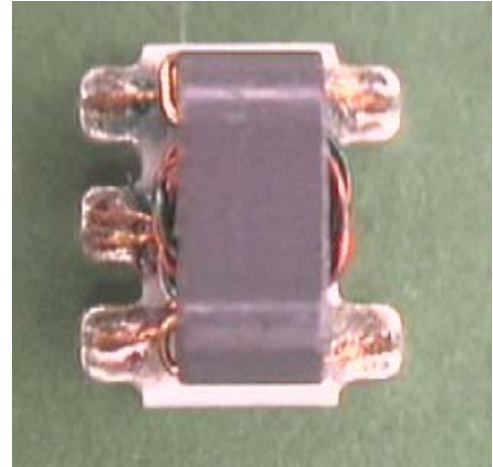

Electrical Specifications: $T_A = 25^\circ\text{C}$, $Z_0 = 50\Omega$ ¹

Parameter	Test Conditions	Frequency	Units	Min	Typ	Max
RF Frequency	—	0.4 - 500	MHz	—	—	—
Insertion Loss	—	1-100	dB	—	—	1
		0.5 - 300	dB			2
		.4-500	dB			3
Amplitude Imbalance	—	1-100	dB	—	0.1	—
		0.5 - 300	dB			0.6
Phase Imbalance	—	1-100	Degrees	—	2	—
		0.5 - 300	Degrees			5
				—		
				—		

Ordering Information

Part Number	Package
MABA-009180-500MHZ	Tape and Reel (2000 piece reels)

* Restrictions on Hazardous Substances, European Union Directive 2002/95/EC.

ADVANCED: Data Sheets contain information regarding a product M/A-COM Technology Solutions is considering for development. Performance is based on target specifications, simulated results, and/or prototype measurements. Commitment to develop is not guaranteed.
PRELIMINARY: Data Sheets contain information regarding a product M/A-COM Technology Solutions has under development. Performance is based on engineering tests. Specifications are typical. Mechanical outline has been fixed. Engineering samples and/or test data may be available. Commitment to produce in volume is not guaranteed.

• **North America** Tel: 800.366.2266 • **Europe** Tel: +353.21.244.6400
• **India** Tel: +91.80.4155721 • **China** Tel: +86.21.2407.1588
Visit www.macomtech.com for additional data sheets and product information.

M/A-COM Technology Solutions, Inc. and its affiliates reserve the right to make changes to the product(s) information contained herein without notice.

MABA-009180-500MHZ



E-Series RF 1:1 Transformer
0.4-500 MHz

MABA-009180-500MHZ
V2

Pin Configuration

Pin No.	Function
1	Secondary Dot
2	Secondary CT
3	Secondary
4	Primary
5	Primary Dot

Schematic

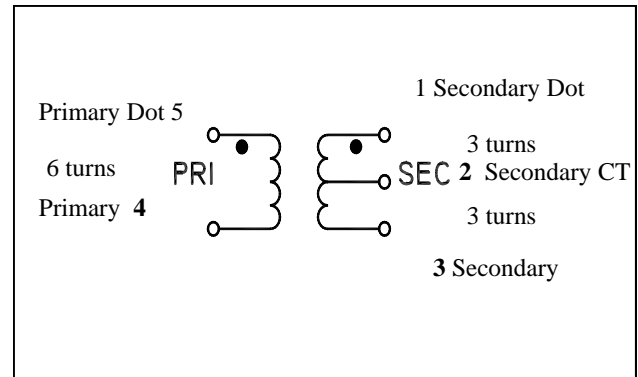

Absolute Maximum Ratings ¹

Parameter	Absolute Maximum
RF Power	250 mW
DC Current	240 mA ²
Operating Temperature	-40°C to +85°C
Storage Temperature	-55°C to +125°C

1. Operation of this device above any one of these parameters may cause permanent damage.
2. The maximum DC current applies to the secondary center tap in applications where the secondary is balanced.

Outline Drawing — SM-22

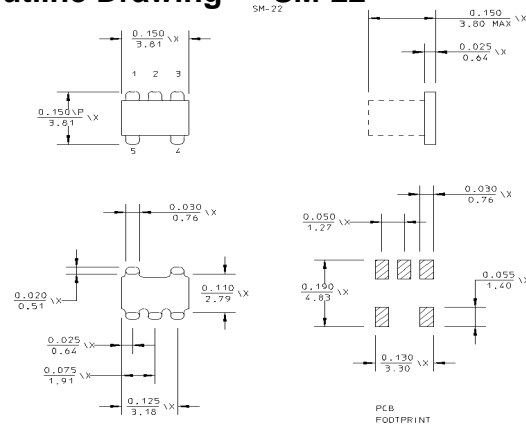

Typical Performance Curves Over Extended

Insertion Loss

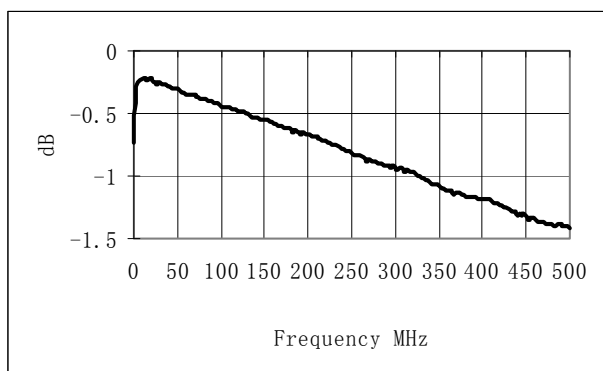

Phase Unbalance

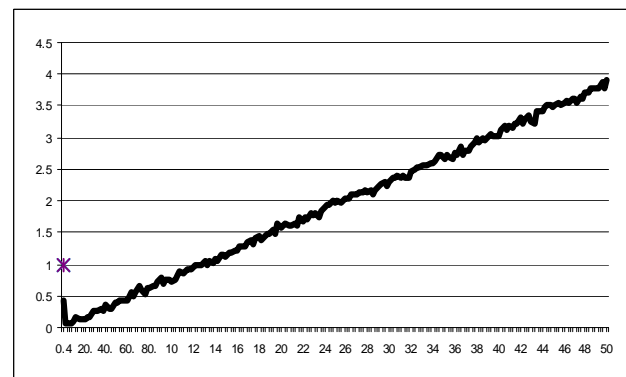

ADVANCED: Data Sheets contain information regarding a product M/A-COM Technology Solutions is considering for development. Performance is based on target specifications, simulated results, and/or prototype measurements. Commitment to develop is not guaranteed.
PRELIMINARY: Data Sheets contain information regarding a product M/A-COM Technology Solutions has under development. Performance is based on engineering tests. Specifications are typical. Mechanical outline has been fixed. Engineering samples and/or test data may be available. Commitment to produce in volume is not guaranteed.

MABA-009180-500MHZ



E-Series RF 1:1 Transformer
0.4-500 MHz

MABA-009180-500MHZ
V2

Typical Performance Curves Over Extended Bandwidth (0.4MHz - 500MHz)

Amplitude Unbalance

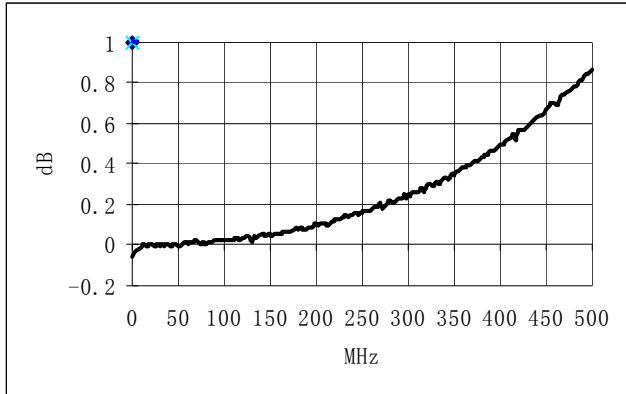

Input Return Loss

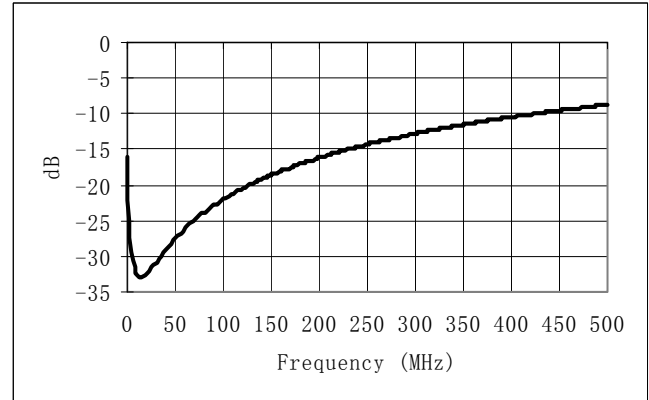

Typical Performance Data

FREQUENCY (MHz)	INSERTION LOSS (dB)	INPUT R.LOSS (dB)	AMPLITUDE BALANCE (dB)	PHASE BALANCE (Deg.)
0.40	0.73	16.13	0.09	0.41
2.00	0.33	27.28	0.05	0.06
5.00	0.25	30.53	0.04	0.08
10.00	0.22	32.76	0.04	0.11
50.00	0.31	27.46	0.03	0.38
100.00	0.44	21.95	0.02	0.73
200.00	0.67	16.18	0.03	1.59
300.00	0.93	12.79	0.18	2.31
400.00	1.19	10.46	0.44	3.02
500.00	1.41	8.72	0.86	3.91

ADVANCED: Data Sheets contain information regarding a product M/A-COM Technology Solutions is considering for development. Performance is based on target specifications, simulated results, and/or prototype measurements. Commitment to develop is not guaranteed.

PRELIMINARY: Data Sheets contain information regarding a product M/A-COM Technology Solutions has under development. Performance is based on engineering tests. Specifications are typical. Mechanical outline has been fixed. Engineering samples and/or test data may be available. Commitment to produce in volume is not guaranteed.

• **North America** Tel: 800.366.2266 • **Europe** Tel: +353.21.244.6400
 • **India** Tel: +91.80.4155721 • **China** Tel: +86.21.2407.1588
 Visit www.macomtech.com for additional data sheets and product information.

M/A-COM Technology Solutions Inc. and its affiliates reserve the right to make changes to the product(s) information contained herein without notice.