

MABA-010314-CT1370



Transformer, 1:1
4.5 MHz - 1200 MHz

RELEASED

Rev. V1

Features

- ◆ 1:1 impedance ratio
- ◆ Transmission line transformer
- ◆ Surface mount
- ◆ Available on tape and reel
- ◆ 260°C reflow compatible
- ◆ RoHS Compliant and Pb free
- ◆ Excellent temperature stability
- ◆ Can be used on 50Ω and 75Ω systems
- ◆ Suitable for all CATV, Broadband and FTTx applications.

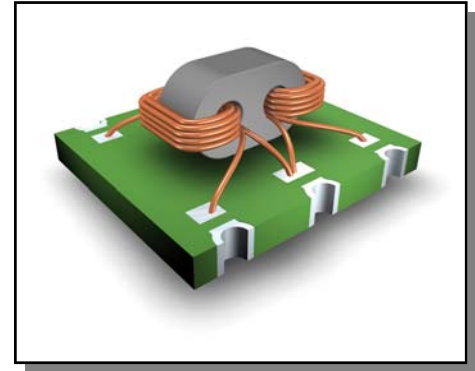

Electrical Specifications: $Z_0 = 75\Omega$, $T_A = 25^\circ\text{C}$, $P_{in} = 0\text{dBm}$

Parameter	Conditions	Units	Min	Typ	Max
Frequency Range		MHz	4.5		1200
Impedance		Ω		75	
Impedance Ratio				1:1	
Insertion Loss 1 (Pin 6 to Pin 1)	4.5 - 870 MHz	dB	-	0.50	1.0
	870 - 1200 MHz	dB	-	1.20	2.0
Insertion Loss 2 (Pin 6 to Pin 3)	4.5 - 870 MHz	dB	-	0.60	1.0
	870 - 1200 MHz	dB	-	0.70	1.4
Amplitude Balance (Nominal 0dB)	4.5 - 50 MHz	dB	-	± 0.9	± 1.3
	50 - 1000 MHz	dB	-	± 0.4	± 1.0
	1000 - 1200 MHz	dB	-	± 0.7	± 1.1
Phase Balance (Nominal 180°)	4.5 - 50 MHz	°	-	± 5	± 15
	50 - 1200 MHz	°	-	± 6	± 10
Input Return Loss (Pin 6)	4.5 - 350 MHz	dB	20	28	-
	350 - 1000 MHz	dB	16	23	-
	1000 - 1200 MHz	dB	13	19	-

Pin Configuration

Pin No.	Function
1	Secondary Dot
2, 5	Not Connected (ground)
3	Secondary
4	Primary
6	Primary Dot

Schematic

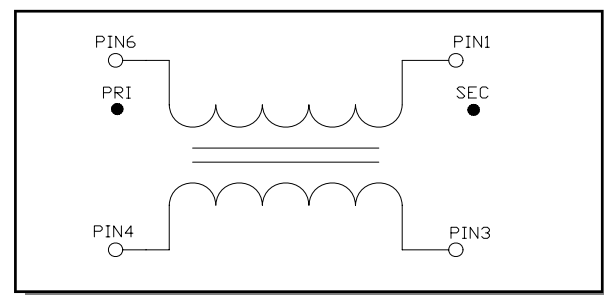

Insertion Loss 1: (Pin 6 to Pin 1)

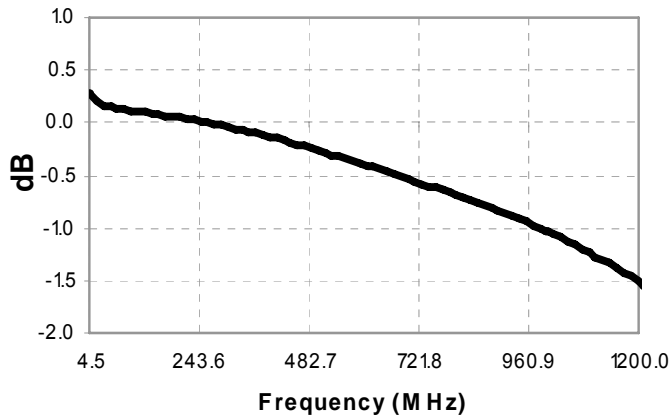

Insertion Loss 2: (Pin 6 to Pin 3)

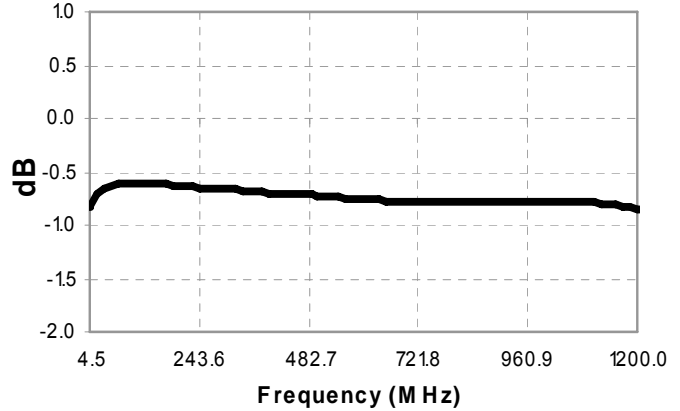

Amplitude Balance:

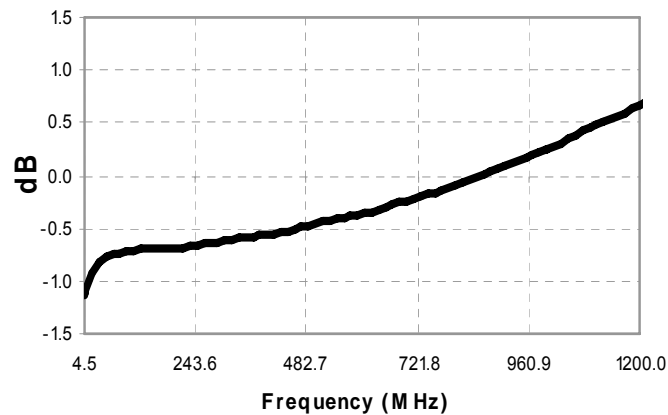

Phase Balance:

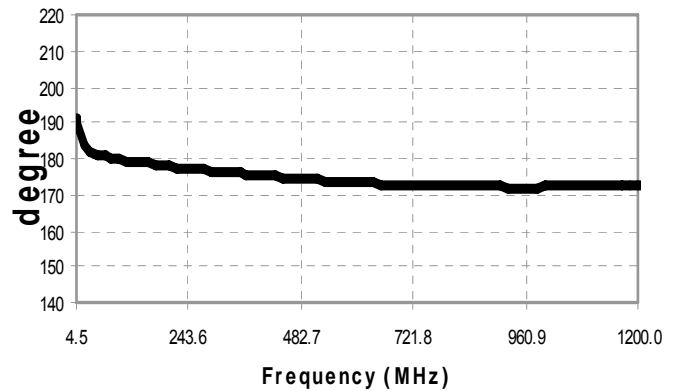

Input Return Loss: (Pin 6)

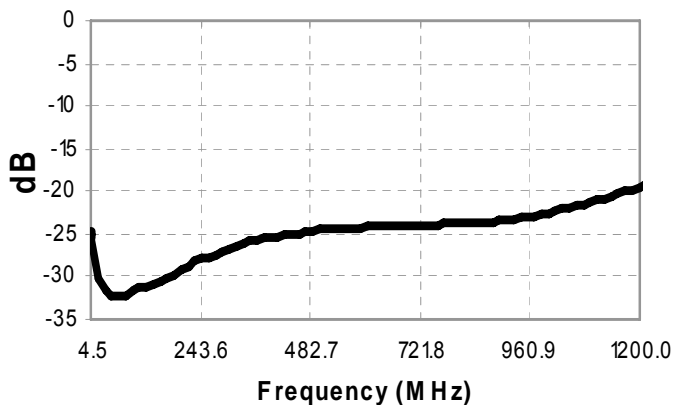

Electrical Specifications: $Z_0 = 75\Omega$, $T_A = 25^\circ\text{C}$, $P_{in} = 0\text{dBm}$

Outline Drawing

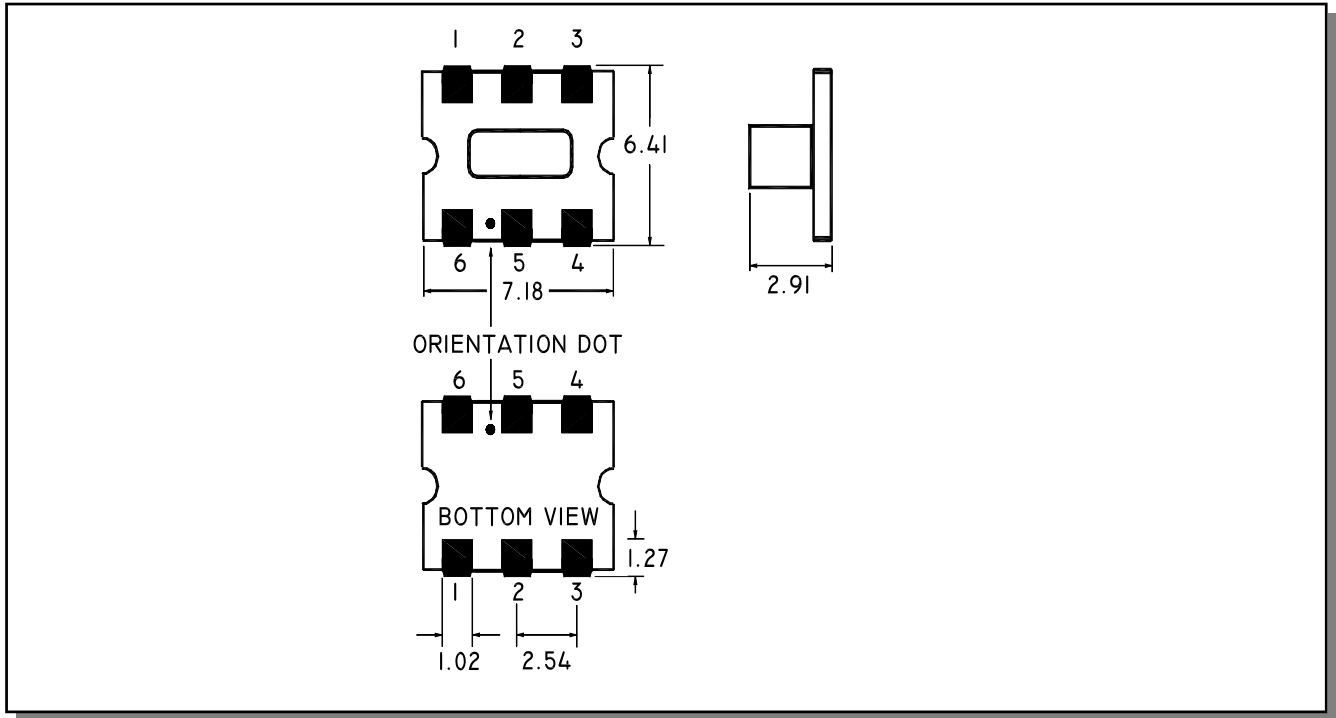

1. Dimensions in mm.
2. Tolerance: $\pm 0.2\text{mm}$ unless otherwise noted.
3. Model number and lot code printed on reel.
4. Finish: Electroless nickel immersion gold

Application Circuit

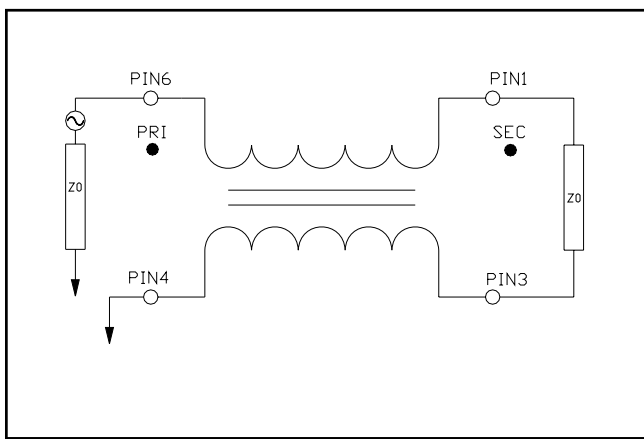

Recommended Footprint

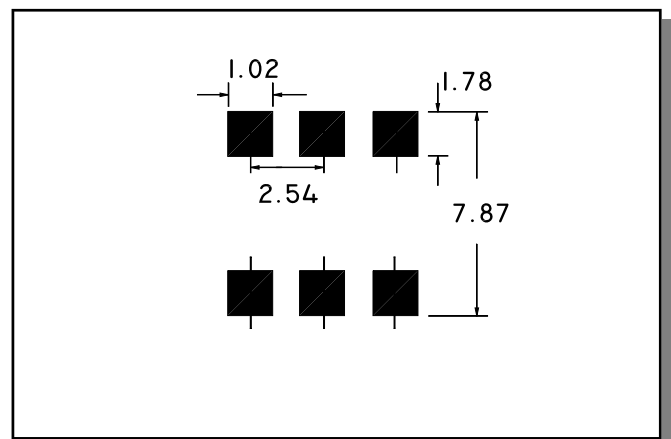

Tape & Reel Information

Parameter	Units	Value
Qty per reel	-	900
Reel Size	mm	330
Tape Width	mm	16
Pitch	mm	12
Ao	mm	6.7
Bo	mm	7.4
Ko	mm	3.1
Orientation	-	F-15
Reference Application Note ANI-019 for orientation		

Ordering Information

Part Number	Description
MABA-010314-CT1370	Tape & Reel
MABA-010314-CT13TB	Customer Evaluation Board

Recommended Maximum Ratings

Parameter	Units	Min	Max
Input Power	mW		250
DC Current	mA		200
Operating Temperature Range	°C	-40	+85
Storage Temperature Range	°C	-55	+125

Temperature data available on request

ECO History

Rev	Date	Description	ECO
V1	28 May 2010	Created datasheet	20100510