

MABA-010374-CT4A40



Transformer, 1:4
10 MHz - 1900 MHz

RELEASED

Rev. V1

Features

- ◆ 1:4 impedance ratio
- ◆ Transmission line Transformer
- ◆ Surface mount
- ◆ Available on tape and reel
- ◆ 260°C reflow compatible
- ◆ RoHS Compliant and Pb free
- ◆ Excellent temperature stability
- ◆ Can be used on 50Ω and 75Ω systems

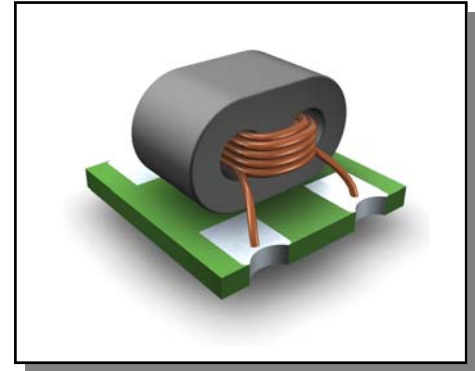

Electrical Specifications: $Z_0 = 50\Omega$, $T_A = 25^\circ\text{C}$, $P_{in} = 0\text{dBm}$

Parameter	Conditions	Units	Min	Typ	Max
Frequency Range		MHz	10		1900
Impedance		Ω		50	
Impedance Ratio				1:4	
Insertion Loss	10 - 600 MHz	dB	-	1.0	1.4
	600 - 1300 MHz	dB	-	1.8	2.5
	1300 - 1900 MHz	dB	-	2.5	3.3
Amplitude Balance	10 - 600 MHz	dB	-	0.1	± 0.5
	600-1000 MHz	dB	-	0.1	± 1.0
	1000-1900 MHz	dB	-	0.0	± 1.4
Phase Balance	10 - 250 MHz	$^\circ$	-	3.0	± 5
	250 - 820 MHz	$^\circ$	-	11.0	± 15
	820-1900 MHz	$^\circ$	-	12.0	± 22
Input Return Loss	10 - 400 MHz	dB	15	16	-
	400 - 870 MHz	dB	9	12	-
	871 - 1900 MHz	dB	6	9	-

Pin Configuration

Pin No.	Function
1	Secondary Dot
2	Center Tap
3	Secondary
4	Primary
6	Primary Dot

Schematic

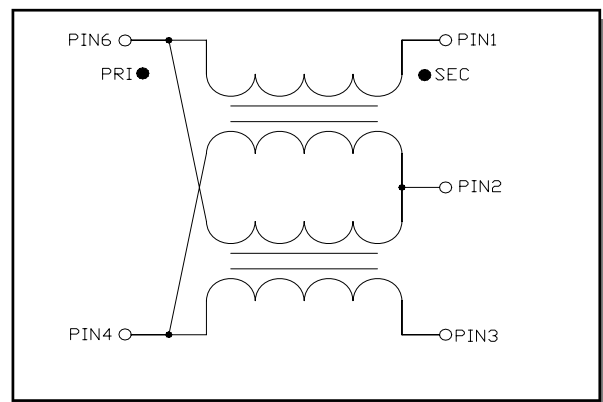

1

ADVANCED: Data Sheets contain information regarding a product M/A-COM Technology Solutions is considering for development. Performance is based on target specifications, simulated results, and/or prototype measurements. Commitment to develop is not guaranteed.

PRELIMINARY: Data Sheets contain information regarding a product M/A-COM Technology Solutions has under development. Performance is based on engineering tests. Specifications are typical. Mechanical outline has been fixed. Engineering samples and/or test data may be available. Commitment to produce in volume is not guaranteed.

• **North America** Tel: 800.366.2266 • **Europe** Tel: +353.21.244.6400

• **India** Tel: +91.80.43537383

• **China** Tel: +86.21.2407.1588

Visit www.macomtech.com for additional data sheets and product information.

M/A-COM Technology Solutions Inc. and its affiliates reserve the right to make changes to the product(s) or information contained herein without notice.

www.BDTTC.com/MACOM

MABA-010374-CT4A40



Transformer, 1:4
10 MHz - 1900 MHz

RELEASED

Rev. V1

Insertion Loss 1: (Pin4 - Pin1)

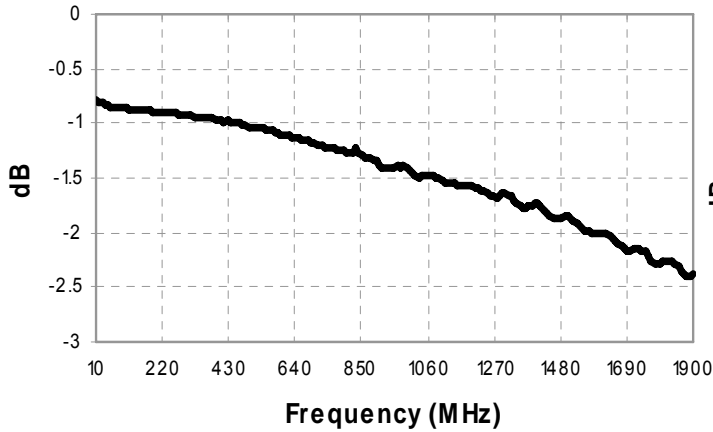

Insertion Loss 2: (Pin4 - Pin3)

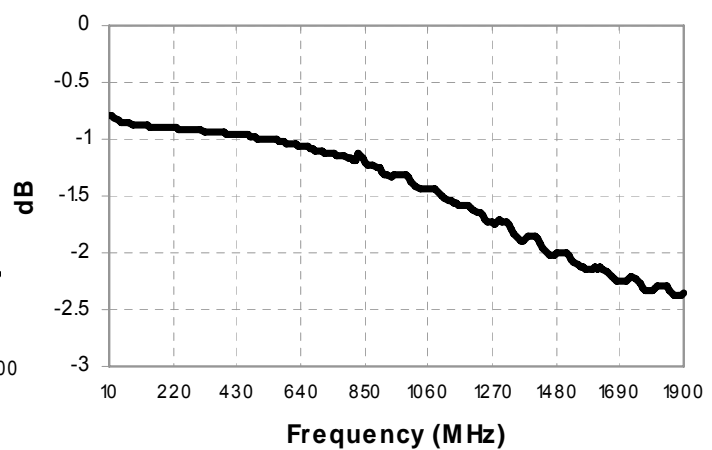

Amplitude balance

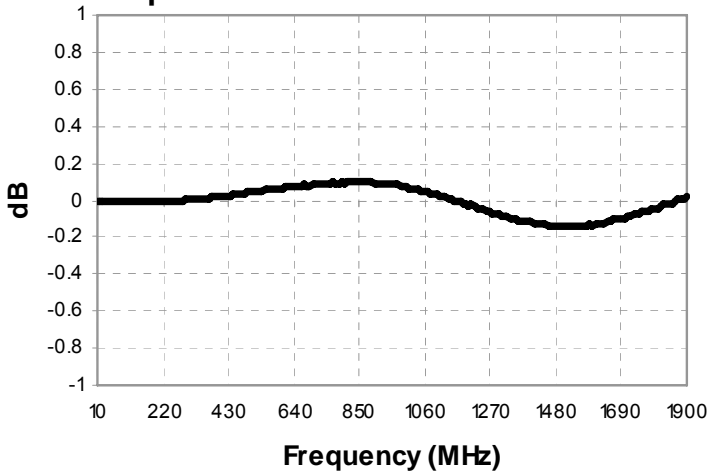

Phase Balance

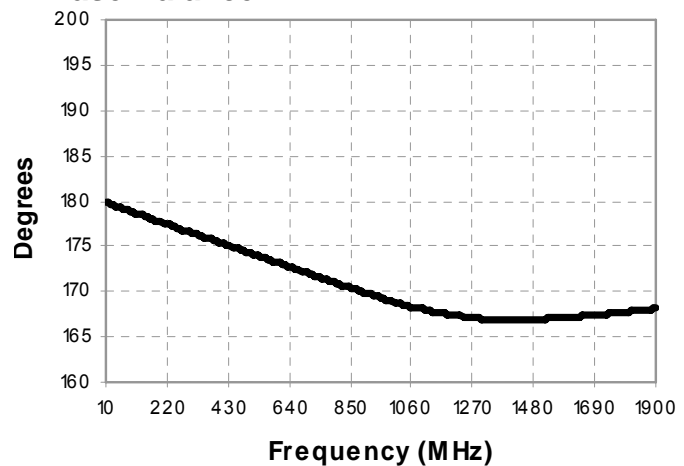

Input Return Loss (Pin 4)

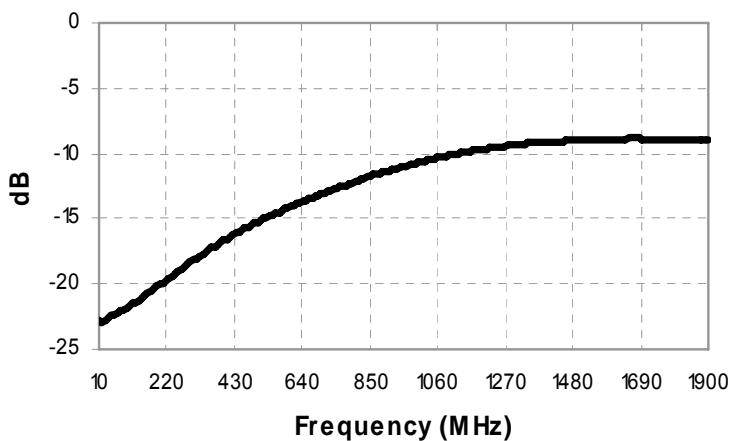

Outline Drawing

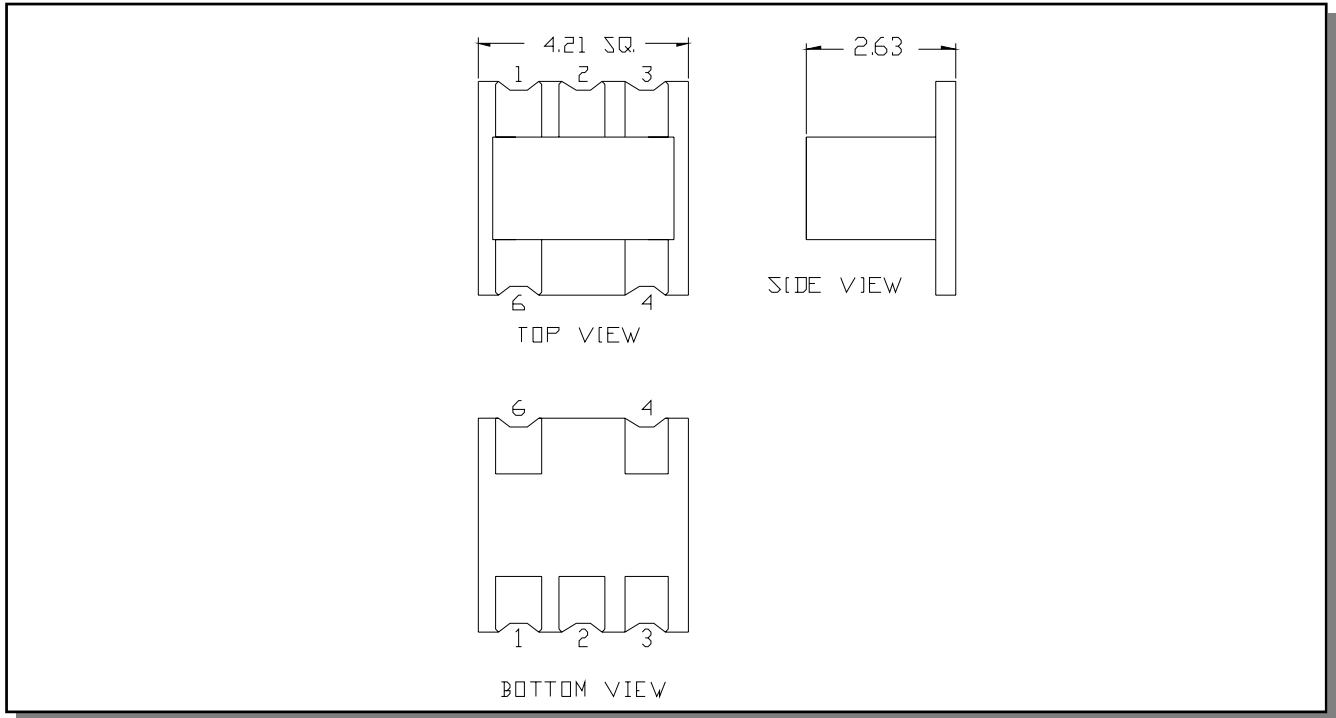

1. Dimensions in mm.
2. Tolerance: $\pm 0.2\text{mm}$ unless otherwise noted.
3. Model number and lot code are printed on the reel.
4. Finish: Electroless nickel immersion gold

Recommended Footprint

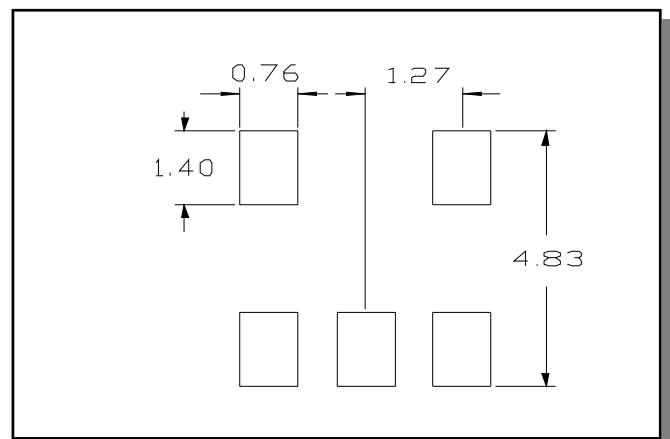

MABA-010374-CT4A40



Transformer, 1:4
10 MHz - 1900 MHz

RELEASED

Rev. V1

Tape & Reel Information

Parameter	Units	Value
Qty per reel	-	2000
Reel Size	mm	330
Tape Width	mm	12.00
Pitch	mm	8.00
Ao	mm	4.50
Bo	mm	4.50
Ko	mm	2.73
Orientation	-	F31
Reference Application Note ANI-019 for orientation		

Ordering Information

Part Number	Description
MABA -010374-CT4A40	Tape & Reel
MABA -010374-CT4ATB	Customer Evaluation Board

Recommended Maximum Ratings

Parameter	Units	Min	Max
Input Power	mW		250
DC Current	mA		200
Operating Temperature Range	°C	-40	+85
Storage Temperature Range	°C	-55	+125

ECO History

Rev	Date	Description	ECO
V1	26 May 2010	Created datasheet	20100464

4

ADVANCED: Data Sheets contain information regarding a product M/A-COM Technology Solutions is considering for development. Performance is based on target specifications, simulated results, and/or prototype measurements. Commitment to develop is not guaranteed.

PRELIMINARY: Data Sheets contain information regarding a product M/A-COM Technology Solutions has under development. Performance is based on engineering tests. Specifications are typical. Mechanical outline has been fixed. Engineering samples and/or test data may be available. Commitment to produce in volume is not guaranteed.

• **North America** Tel: 800.366.2266 • **Europe** Tel: +353.21.244.6400
• **India** Tel: +91.80.43537383 • **China** Tel: +86.21.2407.1588

Visit www.macomtech.com for additional data sheets and product information.

M/A-COM Technology Solutions Inc. and its affiliates reserve the right to make changes to the product(s) or information contained herein without notice.

WWW.BDTTC.COM/MACOM