

# MABA-010655-CF1A40



Transformer, 10/100BASE-T Ethernet Transformer  
1 MHz - 100 MHz

Rev. V2

## Features

- Surface mount
- 100 Ohm bal-bal, 1:1 Impedance ratio
- Product suited for both RX and TX channel
- 260°C reflow compatible
- RoHS\* compliant and lead free
- Available on tape and reel

## Description

M/A-Com Technology Solutions MABA-010655-CF1A40 is a 10/100BASE-T Ethernet Transformer in a low cost, surface mount package.

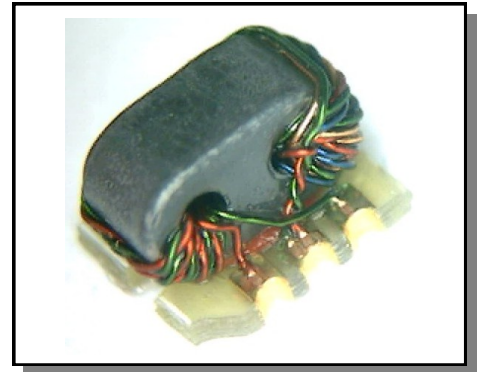

Electrical Specifications:  $T_A = 25^\circ\text{C}$ , 0dBm,  $Z_0 = 50\Omega$ ,  $P_{in} = 0\text{dBm}$

Parameter	Frequency	Units	Min	Typ	Max
Insertion Loss (Sdd21)	1 - 10 MHz	dB	-0.5	-0.20	-
	10 - 65 MHz	dB	-0.5	-0.30	-
	65 - 100 MHz	dB	-0.6	-0.43	-
Return Loss (Sdd11 and Sdd22)	1 - 100 MHz	dB	-	-30	-20
Differential to Common Mode Rejection (Scd21)	1 - 100 MHz	dB	-	-37	-35
DC Resistance Balance	N/A	%	-	1.5	3.5

## Pin Configuration

Pin no.	Function
1	Primary Dot
2	Ground
3	Primary
4	Secondary
5	Ground
6	Secondary Dot

## Schematic

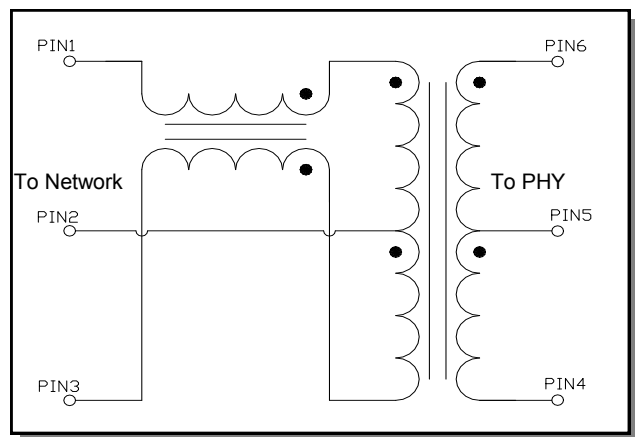

**Note:** Solderable area is underside of the carrier.  
Castellations will not show solder wetting

1

**ADVANCED:** Data Sheets contain information regarding a product M/A-COM Technology Solutions is considering for development. Performance is based on target specifications, simulated results, and/or prototype measurements. Commitment to develop is not guaranteed.  
**PRELIMINARY:** Data Sheets contain information regarding a product M/A-COM Technology Solutions has under development. Performance is based on engineering tests. Specifications are typical. Mechanical outline has been fixed. Engineering samples and/or test data may be available. Commitment to produce in volume is not guaranteed.

• **North America** Tel: 800.366.2266 • **Europe** Tel: +353.21.244.6400  
• **India** Tel: +91.80.43537383 • **China** Tel: +86.21.2407.1588  
Visit [www.macomtech.com](http://www.macomtech.com) for additional data sheets and product information.

M/A-COM Technology Solutions Inc. and its affiliates reserve the right to make changes to the product(s) or information contained herein without notice.

# MABA-010655-CF1A40



Transformer, 10/100BASE-T Ethernet Transformer  
1 MHz - 100 MHz

Rev. V2

Insertion Loss: (Sdd21)

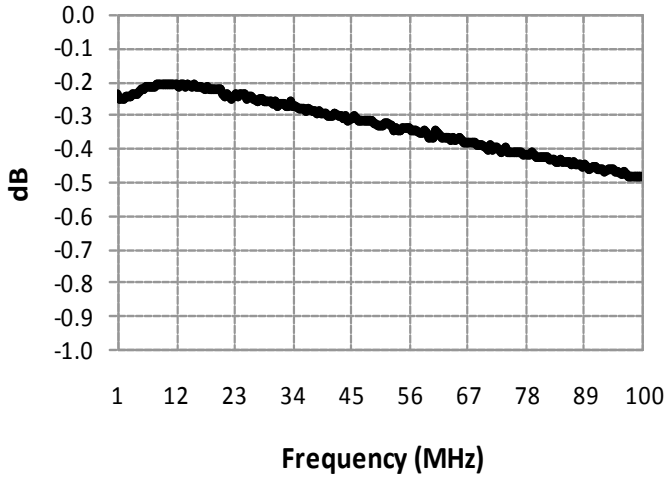

Return Loss: Input (Sdd11)

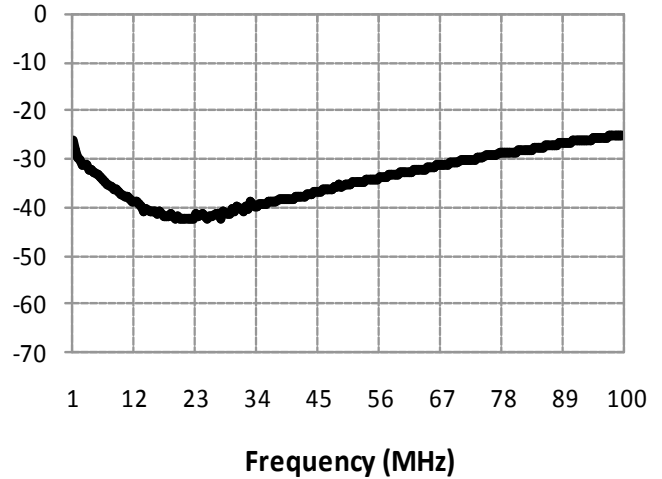

Differential to Common Mode Rejection (Scd21)

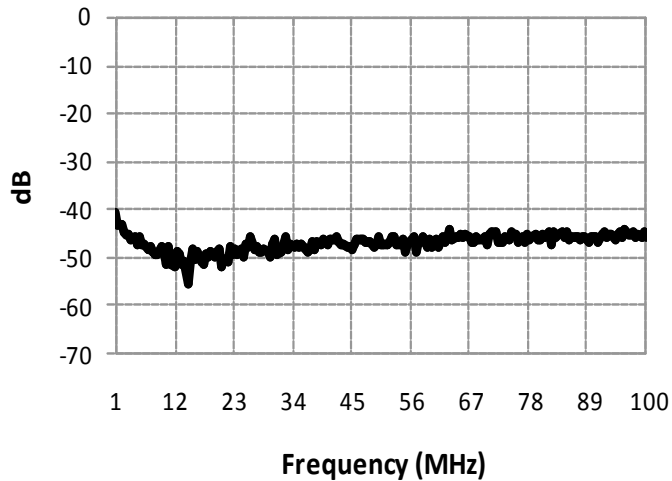

Return Loss: Output (Sdd22)

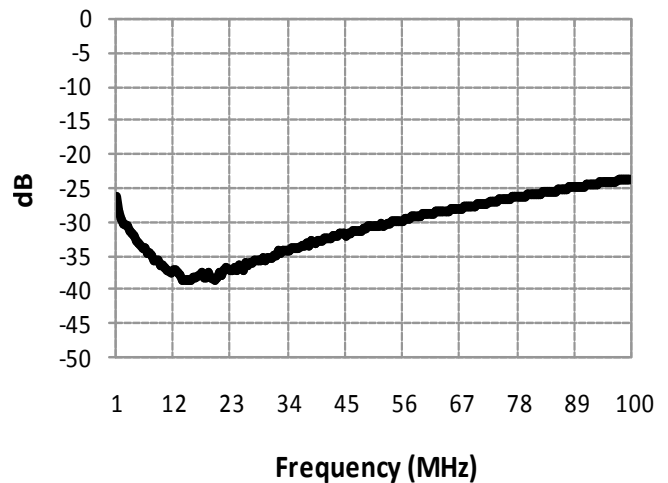

Electrical Specifications:  $Z_0 = 50\Omega$ ,  $T_A = 25^\circ\text{C}$ ,  $P_{in} = 0\text{dBm}$

**ADVANCED:** Data Sheets contain information regarding a product M/A-COM Technology Solutions is considering for development. Performance is based on target specifications, simulated results, and/or prototype measurements. Commitment to develop is not guaranteed.  
**PRELIMINARY:** Data Sheets contain information regarding a product M/A-COM Technology Solutions has under development. Performance is based on engineering tests. Specifications are typical. Mechanical outline has been fixed. Engineering samples and/or test data may be available. Commitment to produce in volume is not guaranteed.

• **North America** Tel: 800.366.2266 • **Europe** Tel: +353.21.244.6400  
• **India** Tel: +91.80.43537383 • **China** Tel: +86.21.2407.1588  
Visit [www.macomtech.com](http://www.macomtech.com) for additional data sheets and product information.

M/A-COM Technology Solutions Inc. and its affiliates reserve the right to make changes to the product(s) or information contained herein without notice.

# MABA-010655-CF1A40



Transformer, 10/100BASE-T Ethernet Transformer  
1 MHz - 100 MHz

Rev. V2

## Outline Drawing

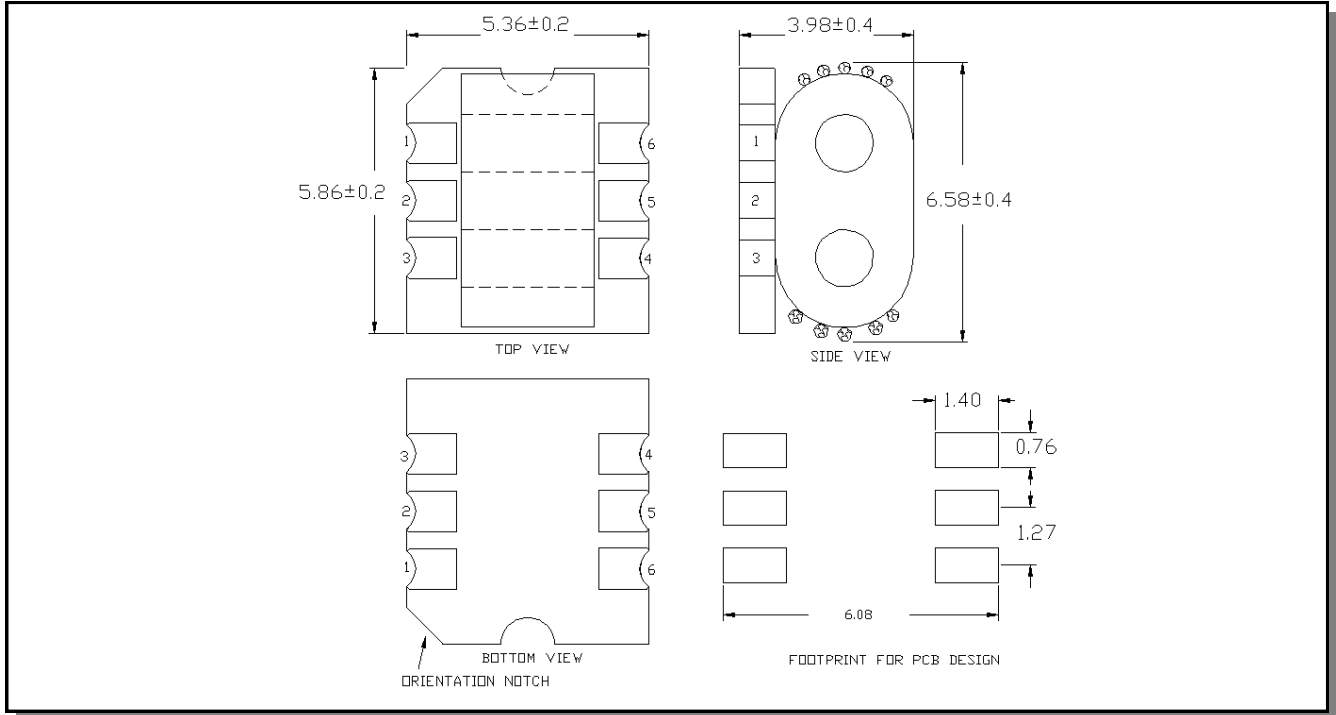

1. Dimensions in mm.
2. Tolerance:  $\pm 0.2$ mm unless otherwise noted.
3. Model number and lot code printed on reel.
4. Plating finish: ENIG on both sides, 0.05 to 0.1  $\mu$ m gold over 3 to 6  $\mu$ m nickel

## Application Circuit

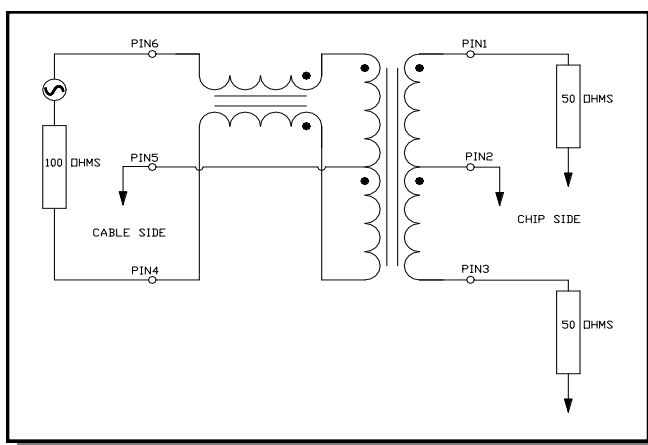

## Recommended Footprint

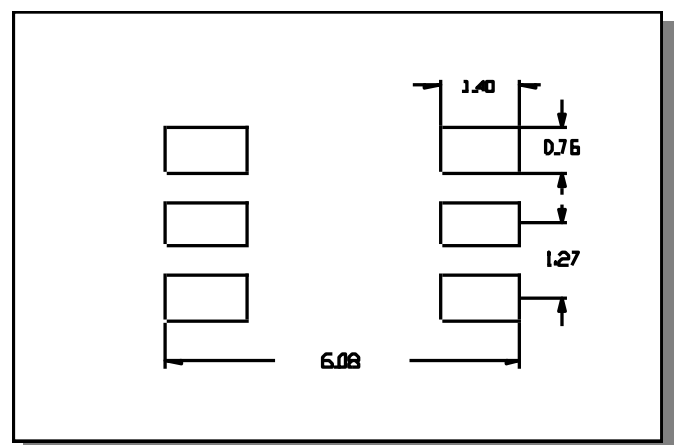

**ADVANCED:** Data Sheets contain information regarding a product M/A-COM Technology Solutions is considering for development. Performance is based on target specifications, simulated results, and/or prototype measurements. Commitment to develop is not guaranteed.  
**PRELIMINARY:** Data Sheets contain information regarding a product M/A-COM Technology Solutions has under development. Performance is based on engineering tests. Specifications are typical. Mechanical outline has been fixed. Engineering samples and/or test data may be available. Commitment to produce in volume is not guaranteed.

• **North America** Tel: 800.366.2266 • **Europe** Tel: +353.21.244.6400  
 • **India** Tel: +91.80.43537383 • **China** Tel: +86.21.2407.1588  
 Visit [www.macomtech.com](http://www.macomtech.com) for additional data sheets and product information.

M/A-COM Technology Solutions Inc. and its affiliates reserve the right to make changes to the product(s) or information contained herein without notice.

# MABA-010655-CF1A40



Transformer, 10/100BASE-T Ethernet Transformer  
1 MHz - 100 MHz

Rev. V2

## Tape & Reel Information

Parameter	Units	Value
Qty per reel	-	900
Reel Size	mm	330
Tape Width	mm	16.00
Pitch	mm	8.00
Ao	mm	5.70
Bo	mm	7.00
Ko	mm	4.20
Orientation	-	F46
Reference Application Note ANI-019 for orientation		

## Ordering Information

Part Number	Description
MABA-010655-CF1A40	Tape & Reel
MABA-010655-CF1ATB	Customer Evaluation Board

## Recommended Maximum Ratings

Parameter	Value
Input power	250mW
DC current	600mA
Hi Pot	1500 Vrms
Operating Temperature	-40°C to +110°C
Storage Temperature	-55°C to +100°C

Temperature data available on request

## ECO History

Rev	Date	Description	ECO
V1	08/07/11	Created datasheet	CO-000884
V2	26/09/11	Optimised carrier tape	CO-002313

4

**ADVANCED:** Data Sheets contain information regarding a product M/A-COM Technology Solutions is considering for development. Performance is based on target specifications, simulated results, and/or prototype measurements. Commitment to develop is not guaranteed.  
**PRELIMINARY:** Data Sheets contain information regarding a product M/A-COM Technology Solutions has under development. Performance is based on engineering tests. Specifications are typical. Mechanical outline has been fixed. Engineering samples and/or test data may be available. Commitment to produce in volume is not guaranteed.

• **North America** Tel: 800.366.2266 • **Europe** Tel: +353.21.244.6400  
• **India** Tel: +91.80.43537383 • **China** Tel: +86.21.2407.1588  
Visit [www.macomtech.com](http://www.macomtech.com) for additional data sheets and product information.

M/A-COM Technology Solutions Inc. and its affiliates reserve the right to make changes to the product(s) or information contained herein without notice.

[www.BDTIC.com/MACOM](http://www.BDTIC.com/MACOM)