

Features

- Industry Standard Surface Mount Package (SC-79)
- Lead-Free (RoHS Compliant)
Available with 260 °C Reflow Compatibility
- Low Loss, High Isolation Switching Diodes
- Tape and Reel Packaging

Description and Applications

M/A-COM offers a silicon PIN diode in low cost, surface mount plastic package for use as a switch where low loss and high isolation is required. These diodes are offered as an RoHS compliant device with 100% matte Sn plating. This particular PIN diode was designed to accommodate circuits requiring the benefits of low resistance and requiring low capacitance for various microwave control circuit applications.

This PIN diode is available in the SC-79 (case style 1279) package. This package is supplied on tape and reel for automatic pick and place assembly. The tape and reel suffix designation is a "T" at the end of the part number.

Absolute Maximum Ratings

@ 25 °C¹ (Unless Otherwise Noted)

Parameter	Absolute Maximum
Operating Temperature	-65°C to +125 °C
Storage Temperature	-65°C to +150 °C
Junction Temperature	+ 175 °C
Reverse Voltage	Voltage Rating
Forward Current	150 mA DC

Electrical Specifications @ 25°C

Standard Part Number	Reverse Voltage ¹ (V)	Junction Capacitance ² Max. (pF)	Total Capacitance ² Max. (pF)	R _s @ 10 mA ³ Max. (Ohms)	Nominal Characteristics	
					Carrier Lifetime ⁴ (ns)	I-Region Thickness (um)
MADP-008120-12790T	100	0.060 @ 10V	0.150 @ 10V	2.5	200	19

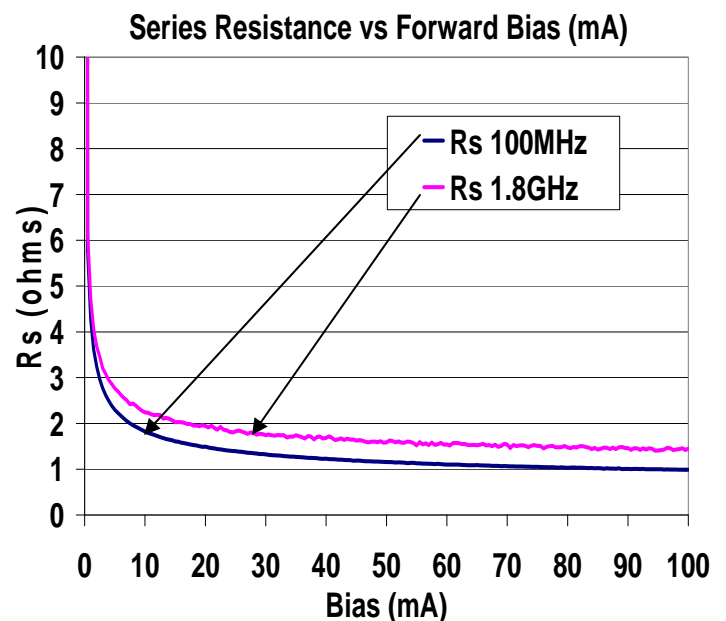
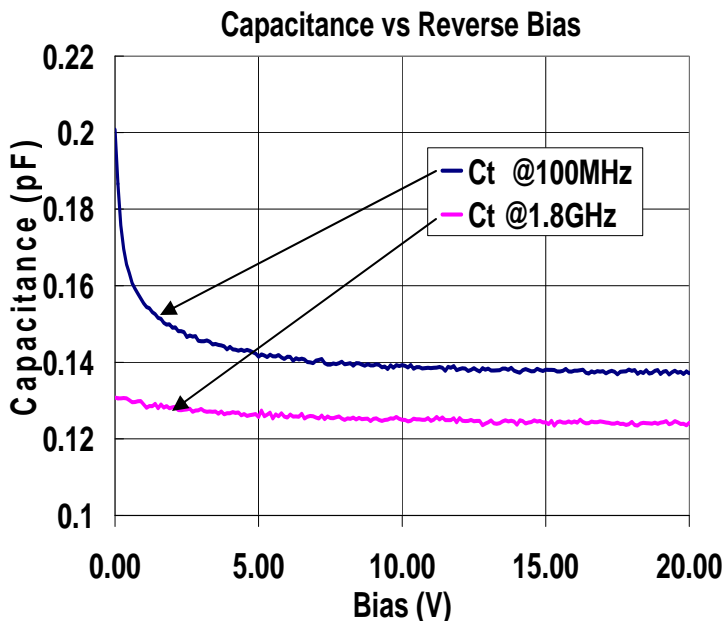

Typical RF Performance

Insertion Loss vs Frequency
"ON" State Forward Bias 10mA

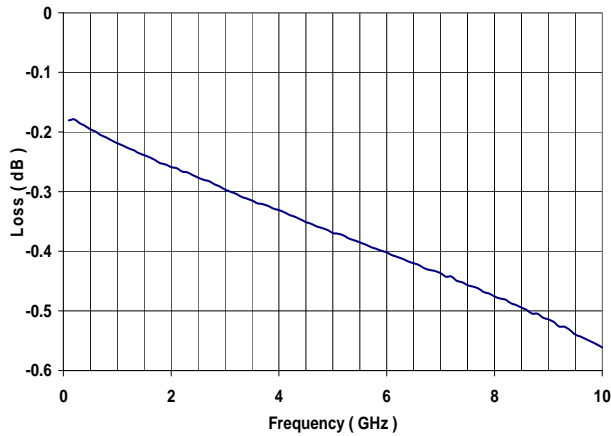

Return Loss vs Frequency
"ON" State Forward Bias 10mA

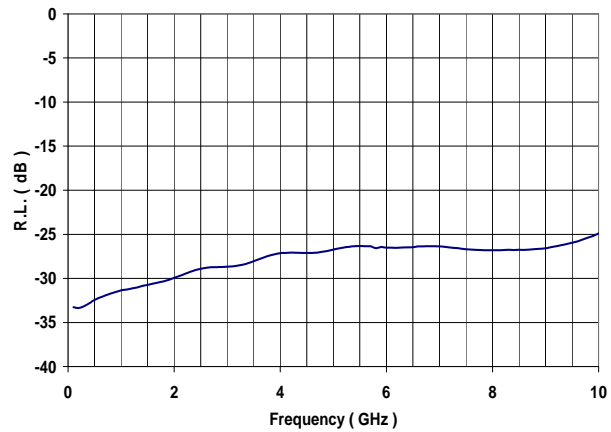

Isolation vs Frequency
"OFF" State Reverse Bias -10V

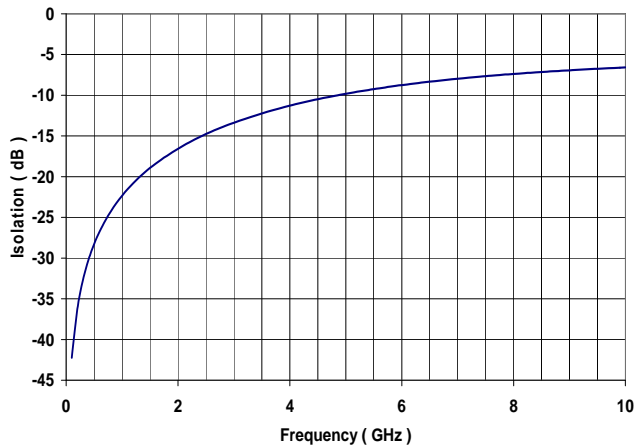

Devices mounted in series configuration and fixture losses removed from data.

MADP-008120-12790T



Surface Mount Plastic PIN Diodes

Rev. V4

S-Parameter Data

MADP-008120-12790T

: Insertion Loss @ 10 mA, 1V in Single Series Diode Configuration, Z0 = 50 Ohms

F (GHz)	S11 Mag	S11 Ang	S21 Mag	S21 Ang	S12 Mag	S12 Ang	S22 Mag	S22 Ang
0.100	0.022	-15.170	0.979	-0.570	0.979	-0.570	0.021	-11.230
0.200	0.021	-9.400	0.980	-1.560	0.980	-1.560	0.021	-4.320
0.300	0.022	-8.740	0.979	-2.470	0.979	-2.470	0.022	-1.650
0.400	0.023	-8.470	0.978	-3.320	0.978	-3.320	0.023	-1.510
0.500	0.024	-8.420	0.978	-4.140	0.978	-4.140	0.024	-4.040
0.600	0.025	-9.370	0.977	-4.960	0.977	-4.960	0.025	-7.280
0.700	0.025	-9.560	0.977	-5.790	0.977	-5.790	0.025	-11.080
0.800	0.026	-9.630	0.976	-6.600	0.976	-6.600	0.026	-14.950
0.900	0.027	-10.130	0.976	-7.410	0.976	-7.410	0.027	-18.340
1.000	0.027	-11.180	0.975	-8.210	0.975	-8.200	0.027	-21.010
1.100	0.027	-13.470	0.975	-9.020	0.975	-9.020	0.028	-22.930
1.200	0.028	-16.910	0.974	-9.820	0.974	-9.820	0.028	-23.660
1.300	0.028	-20.680	0.974	-10.620	0.974	-10.620	0.029	-24.110
1.400	0.029	-24.730	0.973	-11.410	0.973	-11.410	0.029	-24.180
1.500	0.029	-28.640	0.973	-12.220	0.973	-12.220	0.030	-24.360
1.600	0.030	-31.880	0.972	-13.020	0.972	-13.020	0.030	-25.130
1.700	0.030	-34.670	0.972	-13.830	0.972	-13.830	0.031	-26.720
1.800	0.030	-36.090	0.971	-14.600	0.971	-14.600	0.031	-28.760
1.900	0.031	-36.820	0.971	-15.400	0.971	-15.400	0.032	-31.590
2.000	0.032	-37.230	0.971	-16.200	0.971	-16.200	0.033	-34.700
2.100	0.033	-37.670	0.970	-16.990	0.970	-16.990	0.034	-37.980
2.200	0.034	-38.210	0.970	-17.780	0.970	-17.780	0.035	-40.890
2.300	0.034	-39.030	0.970	-18.580	0.970	-18.580	0.036	-43.210
2.400	0.035	-40.590	0.969	-19.380	0.969	-19.380	0.037	-45.310
2.500	0.036	-42.350	0.969	-20.180	0.969	-20.180	0.038	-46.570
2.600	0.036	-44.820	0.968	-20.970	0.968	-20.970	0.038	-47.510
2.700	0.037	-47.340	0.968	-21.760	0.968	-21.760	0.039	-48.060
2.800	0.037	-49.970	0.967	-22.550	0.967	-22.550	0.040	-48.590
2.900	0.037	-52.490	0.967	-23.350	0.967	-23.350	0.040	-49.080
3.000	0.037	-54.590	0.966	-24.130	0.966	-24.130	0.041	-49.680
3.100	0.037	-56.300	0.966	-24.920	0.966	-24.920	0.041	-50.610
3.200	0.037	-57.680	0.966	-25.730	0.966	-25.730	0.042	-51.850
3.300	0.038	-58.500	0.965	-26.500	0.965	-26.500	0.043	-53.420
3.400	0.039	-59.150	0.965	-27.290	0.965	-27.290	0.043	-55.100
3.500	0.040	-59.900	0.964	-28.090	0.964	-28.090	0.044	-56.800
3.600	0.041	-60.440	0.964	-28.870	0.964	-28.870	0.045	-58.580
3.700	0.042	-61.400	0.964	-29.670	0.964	-29.670	0.046	-60.340
3.800	0.043	-62.360	0.963	-30.470	0.963	-30.470	0.047	-61.640
3.900	0.043	-63.520	0.963	-31.250	0.963	-31.250	0.048	-62.860
4.000	0.044	-64.980	0.963	-32.050	0.963	-32.050	0.049	-63.740
4.100	0.044	-66.650	0.962	-32.850	0.962	-32.850	0.049	-64.400
4.200	0.044	-68.080	0.962	-33.630	0.962	-33.630	0.050	-65.020
4.300	0.044	-69.560	0.961	-34.430	0.961	-34.430	0.050	-65.500
4.400	0.044	-70.860	0.961	-35.220	0.961	-35.220	0.051	-65.810
4.500	0.044	-72.070	0.960	-36.010	0.960	-36.010	0.051	-66.470
4.600	0.044	-72.940	0.960	-36.810	0.960	-36.810	0.051	-67.090
4.700	0.044	-73.710	0.960	-37.590	0.960	-37.590	0.052	-67.830
4.800	0.045	-74.390	0.959	-38.390	0.959	-38.390	0.053	-68.770
4.900	0.045	-74.990	0.959	-39.190	0.959	-39.190	0.053	-69.830
5.000	0.046	-75.460	0.958	-39.980	0.958	-39.980	0.054	-70.850
5.100	0.047	-76.260	0.958	-40.780	0.958	-40.780	0.054	-71.960
5.200	0.047	-77.020	0.958	-41.590	0.958	-41.590	0.055	-72.950
5.300	0.048	-77.800	0.957	-42.380	0.957	-42.380	0.056	-73.660
5.400	0.048	-78.490	0.957	-43.180	0.957	-43.180	0.056	-74.540
5.500	0.048	-79.410	0.957	-43.980	0.957	-43.980	0.057	-74.980
5.600	0.048	-80.330	0.956	-44.770	0.956	-44.770	0.057	-75.490
5.700	0.048	-81.070	0.956	-45.570	0.956	-45.570	0.058	-75.750
5.800	0.047	-82.150	0.955	-46.370	0.955	-46.370	0.057	-76.580
5.900	0.048	-82.340	0.955	-47.170	0.955	-47.170	0.058	-76.030
6.000	0.047	-82.800	0.955	-47.970	0.955	-47.970	0.058	-76.240
6.100	0.047	-83.130	0.954	-48.770	0.954	-48.770	0.058	-76.300
6.200	0.047	-83.430	0.954	-49.590	0.954	-49.590	0.059	-76.650
6.300	0.047	-83.650	0.954	-50.380	0.954	-50.380	0.059	-76.890
6.400	0.048	-84.070	0.953	-51.180	0.953	-51.180	0.059	-77.260
6.500	0.048	-84.640	0.953	-51.990	0.953	-51.990	0.059	-78.150
6.600	0.048	-84.660	0.952	-52.800	0.952	-52.800	0.059	-78.220
6.700	0.048	-84.970	0.952	-53.610	0.952	-53.610	0.059	-78.730
6.800	0.048	-85.190	0.952	-54.420	0.952	-54.420	0.059	-79.130
6.900	0.048	-85.460	0.951	-55.230	0.951	-55.230	0.059	-79.460
7.000	0.048	-85.580	0.951	-56.050	0.951	-56.050	0.060	-79.700
7.100	0.048	-85.550	0.950	-56.850	0.950	-56.850	0.060	-79.860
7.200	0.047	-85.290	0.950	-57.680	0.950	-57.680	0.060	-79.560
7.300	0.047	-85.250	0.950	-58.490	0.950	-58.490	0.060	-79.430
7.400	0.047	-84.700	0.949	-59.310	0.949	-59.310	0.060	-79.170
7.500	0.046	-84.300	0.949	-60.120	0.949	-60.120	0.060	-78.790
7.600	0.046	-84.020	0.948	-60.940	0.948	-60.940	0.060	-78.360
7.700	0.046	-83.400	0.948	-61.770	0.948	-61.770	0.060	-77.920
7.800	0.046	-82.890	0.948	-62.580	0.948	-62.580	0.060	-77.490
7.900	0.046	-82.280	0.947	-63.400	0.947	-63.400	0.060	-77.120
8.000	0.046	-81.610	0.947	-64.220	0.947	-64.220	0.060	-76.540
8.100	0.046	-80.960	0.946	-65.050	0.946	-65.050	0.060	-76.370
8.200	0.046	-80.450	0.946	-65.870	0.946	-65.870	0.060	-75.880
8.300	0.046	-79.740	0.945	-66.710	0.945	-66.710	0.060	-75.310
8.400	0.046	-78.800	0.945	-67.550	0.945	-67.550	0.060	-74.840
8.500	0.046	-78.050	0.945	-68.380	0.945	-68.380	0.060	-74.380
8.600	0.046	-76.690	0.944	-69.200	0.944	-69.200	0.060	-73.720
8.700	0.046	-75.220	0.944	-70.030	0.944	-70.030	0.060	-72.950
8.800	0.046	-73.840	0.944	-70.880	0.944	-70.880	0.061	-72.390
8.900	0.047	-72.270	0.943	-71.710	0.943	-71.710	0.061	-71.000
9.000	0.047	-70.680	0.943	-72.560	0.943	-72.560	0.062	-70.000
9.100	0.048	-69.190	0.942	-73.400	0.942	-73.400	0.062	-68.900
9.200	0.048	-67.550	0.941	-74.250	0.941	-74.250	0.062	-67.920
9.300	0.049	-66.230	0.941	-75.090	0.941	-75.090	0.063	-66.540
9.400	0.050	-64.590	0.941	-75.930	0.941	-75.930	0.063	-65.420
9.500	0.050	-63.310	0.940	-76.770	0.940	-76.770	0.064	-64.240
9.600	0.051	-62.050	0.939	-77.630	0.939	-77.630	0.064	-63.200
9.700	0.053	-60.350	0.939	-78.490	0.939	-78.490	0.065	-62.010
9.800	0.054	-59.300	0.938	-79.350	0.938	-79.350	0.066	-60.960
9.900	0.055	-57.900	0.938	-80.200	0.938	-80.200	0.067	-60.070
10.000	0.057	-56.400	0.937	-81.060	0.937	-81.060	0.068	-58.840

MADP-008120-12790T

: Isolation @ -10V, 0mA in Single Series Diode Configuration, Z0 = 50 Ohms

F (GHz)	S11 Mag	S11 Ang	S21 Mag	S21 Ang	S12 Mag	S12 Ang	S22 Mag	S22 Ang
0.100	1.004	-1.290	0.008	86.770	0.008	86.770	0.995	-1.240
0.200	1.004	-2.610	0.015	86.680	0.015	86.680	0.997	-2.500
0.300	1.005	-3.970	0.023	85.550	0.023	85.550	0.996	-3.760
0.400	1.006	-5.310	0.031	84.170	0.031	84.170	0.995	-4.970
0.500	1.006	-6.600	0.039	82.860	0.039	82.860	0.995	-6.210
0.600	1.007	-7.970	0.046	81.610	0.046	81.610	0.994	-7.410
0.700	1.006	-9.290	0.054	80.220	0.054	80.220	0.993	-8.660
0.800	1.006	-10.630	0.061	79.000	0.061	79.000	0.993	-9.880
0.900	1.005	-11.980	0.069	77.790	0.069	77.790	0.992	-11.090
1.000	1.005	-13.270	0.076	76.530	0.076	76.530	0.992	-12.300
1.100	1.003	-14.610	0.084	75.230	0.084	75.230	0.993	-13.520
1.200	1.000	-15.920	0.091	73.910	0.091	73.910	0.992	-14.740
1.300	1.000	-17.180	0.099	72.610	0.099	72.610	0.992	-15.990
1.400	1.002	-18.470	0.106	71.270	0.106	71.270	0.994	-17.220
1.500	0.998	-19.780	0.113	70.000	0.113	70.000	0.988	-18.440
1.600	0.997	-21.070	0.120	68.850	0.120	68.850	0.987	-19.660
1.700	0.999	-22.520	0.127	67.400	0.127	67.400	0.987	-21.040
1.800	0.996	-23.660	0.134	66.170	0.134	66.170	0.983	-22.020
1.900	0.996	-24.990	0.141	64.940	0.141	64.940	0.982	

Mounting Information

The illustration indicates the recommended mounting pad configuration for the SC-79 package. Solder paste containing flux should be screened onto the pads to a thickness of 0.005-0.007 inches. The plastic package is placed in position, firmly adhering to the solder paste.

Permanent attachment is performed by a reflow soldering procedure during which the tab temperature does not exceed +275 °C and the body temperature does not exceed +260 °C.

Please refer to Application Note M538 for surface mounting instructions.

SC-79

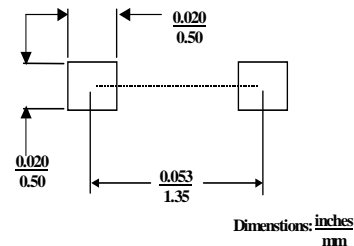

Case Styles (Cont'd)

SC-79

Case Style 1279

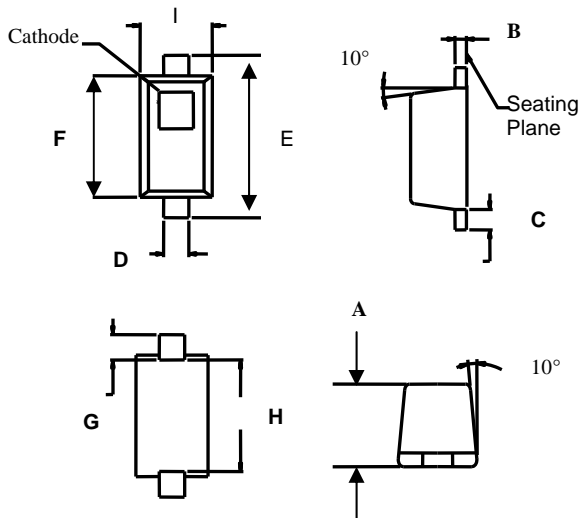

SC-79 (Case Style 1279)

DIM.	INCHES		MILLIMETERS	
	MIN.	MAX.	MIN.	MAX.
A	0.020	0.028	0.51	0.71
B	0.003	0.008	0.08	0.20
C	0.006	0.010	0.15	0.25
D	0.010	0.014	0.25	0.36
E	0.059	0.067	1.50	1.70
F	0.043	0.051	1.09	1.30
G	0.011	0.012	0.28	0.30
H	0.037	0.043	0.94	1.09
I	0.027	0.035	0.69	0.89