

Features

- Input Power @ 1 dB Compression: +15 dBm
- High LO to RF Isolation: 35 dB
- LO Drive Level: +3 to +8 dBm
- DC - 200 MHz 3 dB IF Bandwidth
- Does not require DC bias
- Lead-Free SOT-25 Package
- 100% Matte Tin Plating over Copper
- Halogen-Free "Green" Mold Compound
- 260°C Reflow Compatible
- RoHS* Compliant Version of MD54-0005

Description

M/A-COM's MAMXSS0012 is a passive mixer that achieves the performance of a double balanced diode mixer in a lead-free SOT-25 package. The MAMXSS0012 is ideally suited for use where high level RF signals and very wide dynamic range are required. Typical applications include frequency up/down conversion, modulation, and demodulation in receivers and transmitters for base station and portable systems.

The MAMXSS0012 employs GaAs FETs as mixing elements to achieve a very wide dynamic range in a low cost plastic package. The mixer operates with LO drive levels of +3 dBm to +8 dBm. The LO port may be externally tuned for operation in various frequency bands.

M/A-COM's GaAs IC is fabricated using a mature 0.5 micron gate length GaAs MESFET process. The process features full passivation for increased performance and reliability.

Ordering Information ¹

Part Number	Package
MAMXSS0012	Bulk Packaging
MAMXSS0012TR-3000	3000 piece reel
MAMXSS0012SMB	Designers Kit

1. Reference Application Note M513 for reel size information.

Functional Schematic

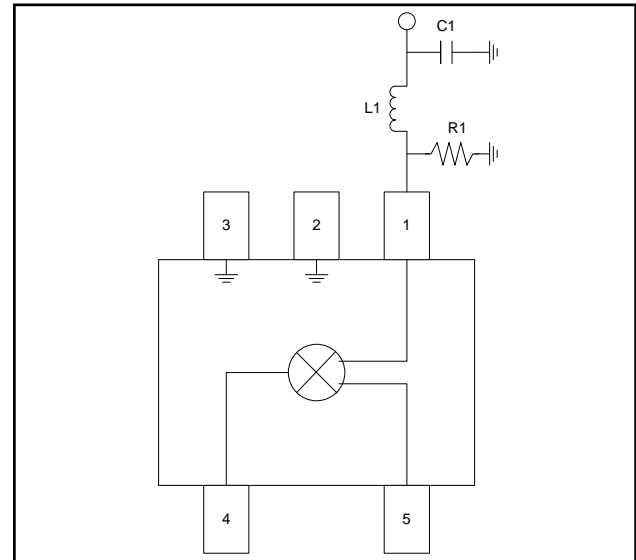

Pin Configuration

Pin No.	Function	Pin No.	Function
1	LO	4	RF
2	Ground	5	IF
3	Ground		

External Circuitry Parts List ²

Ref. Designation	LO = 840 MHz	LO = 900 MHz
R1	820 Ohms	820 Ohms
L1	22 nH	18 nH
C1	3.3 pF	4 pF

2. All off-chip components are low-cost surface mount components obtainable from multiple sources (0.060 in. x 0.030 in. or 0.080 in. x 0.050 in.).

* Restrictions on Hazardous Substances, European Union Directive 2002/95/EC.

ADVANCED: Data Sheets contain information regarding a product M/A-COM Technology Solutions is considering for development. Performance is based on target specifications, simulated results, and/or prototype measurements. Commitment to develop is not guaranteed.
PRELIMINARY: Data Sheets contain information regarding a product M/A-COM Technology Solutions has under development. Performance is based on engineering tests. Specifications are typical. Mechanical outline has been fixed. Engineering samples and/or test data may be available. Commitment to produce in volume is not guaranteed.

• **North America** Tel: 800.366.2266 / Fax: 978.366.2266
• **Europe** Tel: 44.1908.574.200 / Fax: 44.1908.574.300
• **Asia/Pacific** Tel: 81.44.844.8296 / Fax: 81.44.844.8298
Visit www.macomtech.com for additional data sheets and product information.

M/A-COM Technology Solutions Inc. and its affiliates reserve the right to make changes to the product(s) or information contained herein without notice.

Electrical Specifications: RF=900 MHz (-10 dBm), LO=840 MHz (+5 dBm), IF=60 MHz, T_A = 25°C

Parameter	Test Conditions	Units	Min.	Typ.	Max.
Conversion Loss	—	dB	—	8.0	9.0
Isolation	LO to RF	dB	—	35	—
	LO to IF	dB	—	25	—
	RF to IF	dB	—	20	—
VSWR	RF Port	Ratio	—	2.0:1	—
	LO Port ²	Ratio	—	2.0:1	—
	IF Port	Ratio	—	2.0:1	—
Input 1 dB Compression	RF Freq. = 900 MHz, LO = +5 dBm	dBm	—	15	—
Two-Tone IM Ratio ⁴	Two tones at -10 dBm each, Tone spacing = 100 KHz, IF = 60 MHz	dBc	—	55	—

3. With external LO Port matching. See functional schematic.
4. IMR vs. RF Drive can be calculated by the formula: $IMR = 40 - 1.5 * P_{IN}$

Absolute Maximum Ratings ^{5,6}

Parameter	Absolute Maximum
RF Input Power	+27 dBm
Low Drive Power	+27 dBm
Storage Temperature	-65°C to +150°C
Operating Temperature	-40°C to +85°C

5. Exceeding any one or combination of these limits may cause permanent damage to this device.
6. M/A-COM does not recommend sustained operation near these survivability limits.

Lead-Free SOT-25 Plastic Package †

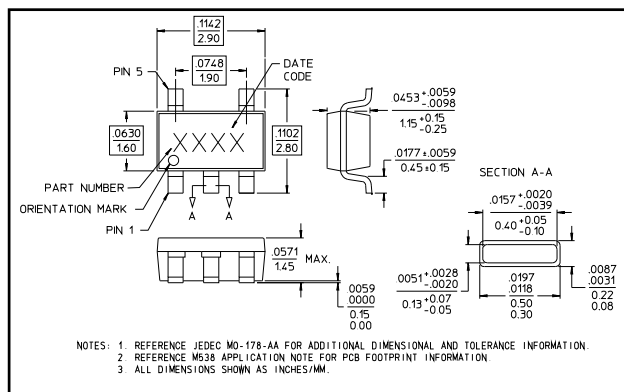

† Reference Application Note M538 for lead-free solder reflow recommendations.

Spurious Table

Harmonic of LO	4x	23.0 10.6	36.5 39.9	53.8 56.1	63.8 58.3	68.6 58.8
	3x	34.1 21.3	21.6 21.8	53.9 57.6	53.4 59.3	67.3 57.2
	2x	17.7 6.6	44.0 44.8	51.6 55.5	65.2 58.4	66.2 56.3
	1x	14.3 4.0	0 0	57.0 57.6	63.7 56.3	67.0 56.9
	0x	X X	13.9 13.4	50.2 53.1	59.1 56.5	67.2 57.1
			0x	1x	2x	3x
Harmonic of RF						

The spurious table shows the spurious signals resulting from the mixing of the RF and LO input signals, assuming down conversion. Mixing products are indicated relative to the IF. The lower frequency mixing term is shown for two different RF input levels. The top number is for an RF input power of 0 dBm, the lower number is for -10 dBm.

$$|nF_{RF} - mF_{LO}|, RF = 0 \text{ dBm}$$

$$|nF_{RF} - mF_{LO}|, RF = -10 \text{ dBm}$$

RF Frequency = 900 MHz
LO Frequency = 840 MHz

Recommended PCB Configuration

Layout View

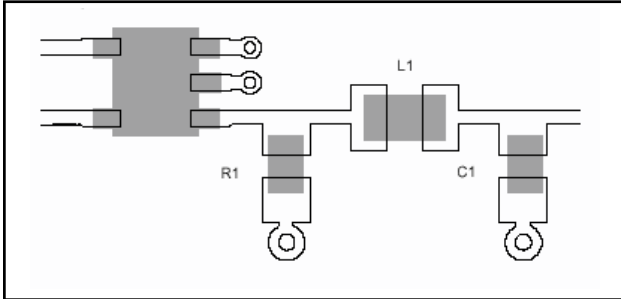

Cross Section View

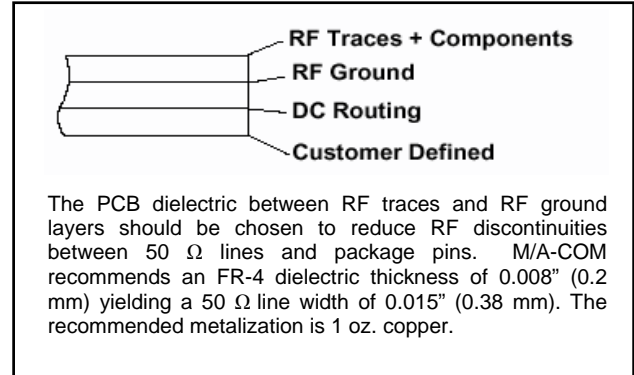

Typical Performance Curves

- **Test Conditions for Down Converter Application:** RF=900 MHz (-10 dBm), IF=60 MHz, LO=840 MHz (+5 dBm), LO Port match shown herein.
- **Test Conditions for Up Converter Application:** LO=840 MHz (+5 dBm), IF=60 MHz (-10 dBm), RF=900 MHz, LO Port match shown herein.

Conversion Loss

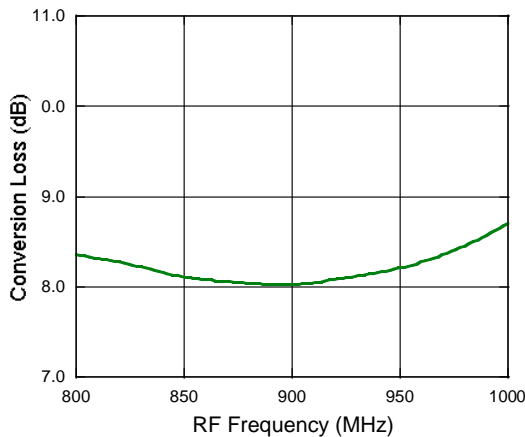

VSWR

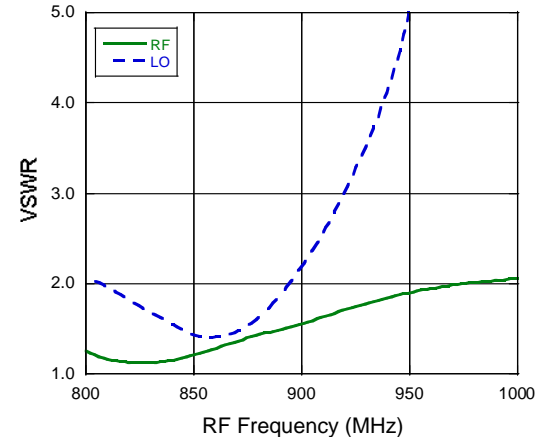

Two-Tone IMR

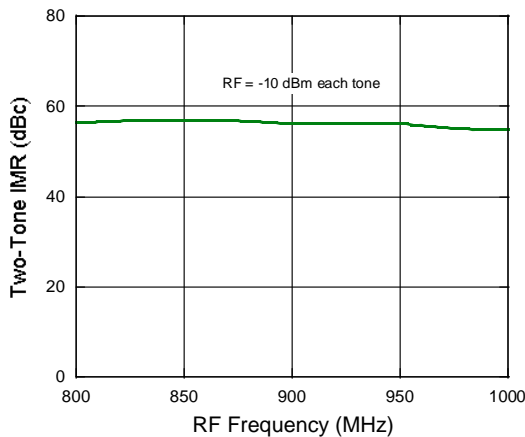

Isolation

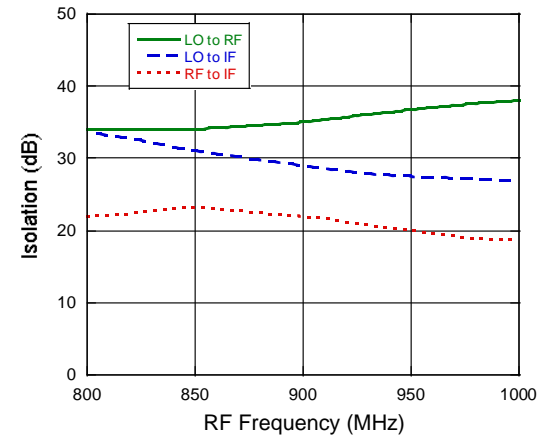

ADVANCED: Data Sheets contain information regarding a product M/A-COM Technology Solutions is considering for development. Performance is based on target specifications, simulated results, and/or prototype measurements. Commitment to develop is not guaranteed.
PRELIMINARY: Data Sheets contain information regarding a product M/A-COM Technology Solutions has under development. Performance is based on engineering tests. Specifications are typical. Mechanical outline has been fixed. Engineering samples and/or test data may be available. Commitment to produce in volume is not guaranteed.

- **North America** Tel: 800.366.2266 / Fax: 978.366.2266
 - **Europe** Tel: 44.1908.574.200 / Fax: 44.1908.574.300
 - **Asia/Pacific** Tel: 81.44.844.8296 / Fax: 81.44.844.8298
- Visit www.macomtech.com for additional data sheets and product information.

M/A-COM Technology Solutions Inc. and its affiliates reserve the right to make changes to the product(s) or information contained herein without notice.