

Features

- Small Size, Low Profile
- Superior Repeatability (Lot-to-Lot Variation)
- Typical Isolation 25 dB
- Typical Insertion Loss 1.0 dB
- Low Cost
- Lead-Free SOIC-16 Package
- 100% Matte Tin Plating over Copper
- Halogen-Free “Green” Mold Compound
- 260°C Reflow Compatible
- RoHS* Compliant Version of DS56-0006

Description

M/A-COM’s MAPDCC0020 is an IC-based monolithic power splitter/combiner in a low cost SOIC-16 plastic package. This 6-way power divider is ideally suited for applications where PCB real estate is at a premium and standard packaging for automated assembly and low cost are critical. Typical applications include base stations, portables, and peripheral devices (PCMCIA cards) for wireless standards such as PCS, PCN, DECT, PHS, and DCS-1800. Available in Tape and Reel.

The MAPDCC0020 is fabricated using passive-integrated circuit process. This process features full-chip passivation for increased performance and reliability.

Ordering Information

Part Number	Package
MAPDCC0020	Bulk Packaging
MAPDCC0020-TR	1000 piece reel
MAPDCC0020-TB	Sample Test Board

Note: Reference Application Note M513 for reel size information.

Functional Block Diagram¹

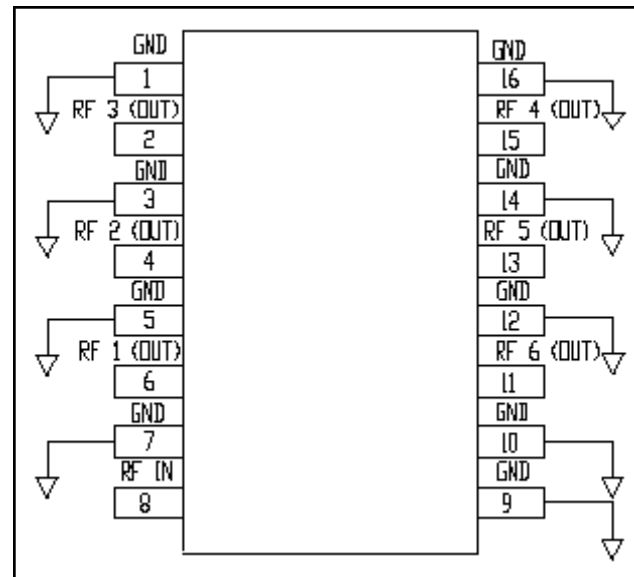

1. All unused pins must be RF and DC grounded.

Pin Configuration

Pin No.	Function	Pin No.	Function
1	GND	9	GND
2	RF 3 (OUT)	10	GND
3	GND	11	RF 6 (OUT)
4	RF 2 (OUT)	12	GND
5	GND	13	RF 5 (OUT)
6	RF 1 (OUT)	14	GND
7	GND	15	RF 4 (OUT)
8	RF IN	16	GND

* Restrictions on Hazardous Substances, European Union Directive 2002/95/EC.

Electrical Specifications: $T_A = 25^\circ\text{C}$, $Z_0 = 50\Omega$

Parameter	Units	Min	Typ	Max
Insertion Loss above 7.8 dB 1700 – 2000 MHz 1850 – 1910 MHz	dB	—	1.3	1.8
	dB	—	1.0	1.5
Isolation 1700 – 2000 MHz 1850 – 1910 MHz	dB	18	25	—
	dB	21	26	—
VSWR Input 1700 – 2000 MHz 1850 – 1910 MHz Output 1700 – 2000 MHz 1850 – 1910 MHz	—	—	1.7:1	2.0:1
	—	—	1.3:1	1.7:1
	—	—	1.3:1	1.7:1
	—	—	1.1:1	1.3:1
Amplitude Balance 1700 – 2000 MHz 1850 – 1910 MHz	dB	—	0.8	1.3
	dB	—	1.0	1.3
Phase Balance 1700 – 2000 MHz 1850 – 1910 MHz	Deg.	—	10	20
	Deg.	—	8	16

Absolute Maximum Ratings ^{2,3}

Parameter	Absolute Maximum
Input Power ⁴	1 W CW
Operating Temperature	-40°C to +85°C
Storage Temperature	-65°C to +150°C

- Exceeding any one or combination of these limits may cause permanent damage to this device.
- M/A-COM does not recommend sustained operation near these survivability limits.
- With internal load dissipation of 0.125 W maximum.

Handling Procedures

Please observe the following precautions to avoid damage:

Static Sensitivity

GMIC Circuits are sensitive to electrostatic discharge (ESD) and can be damaged by static electricity. Proper ESD control techniques should be used when handling these devices.

Typical Performance Curves

Insertion Loss vs. Frequency

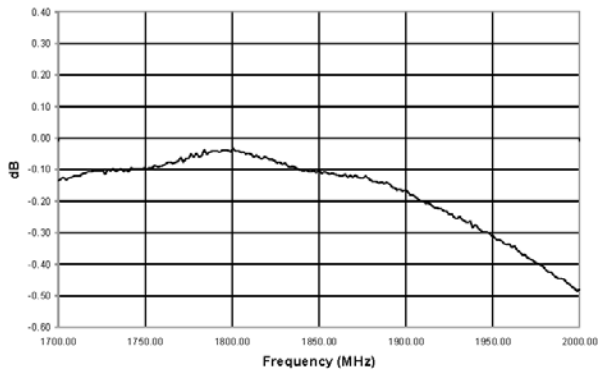

Amplitude Imbalance vs. Frequency

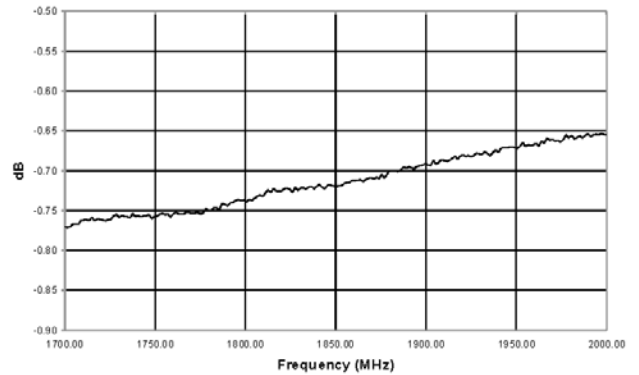

Isolation vs. Frequency

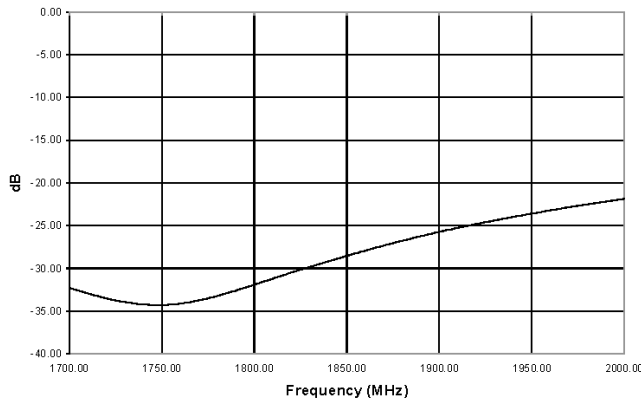

Phase Imbalance vs. Frequency

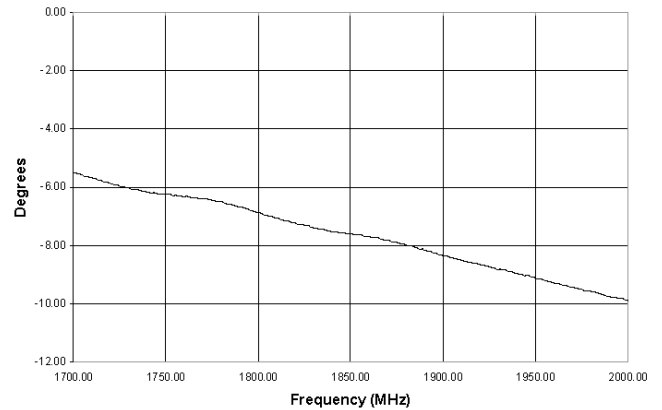

Input VSWR vs. Frequency

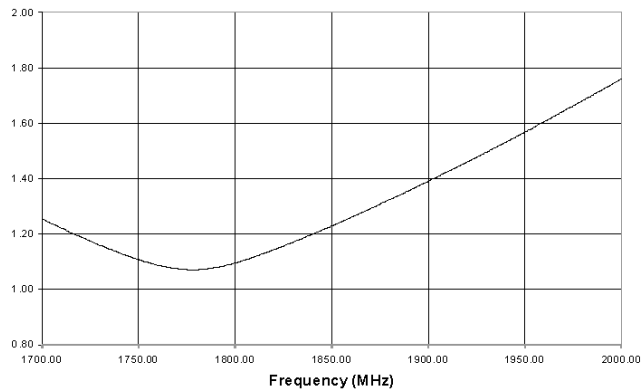

Output VSWR vs. Frequency

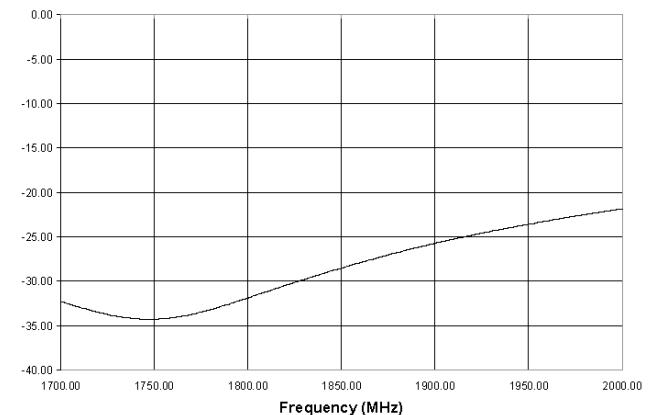

Lead-Free, SOIC-16[†]

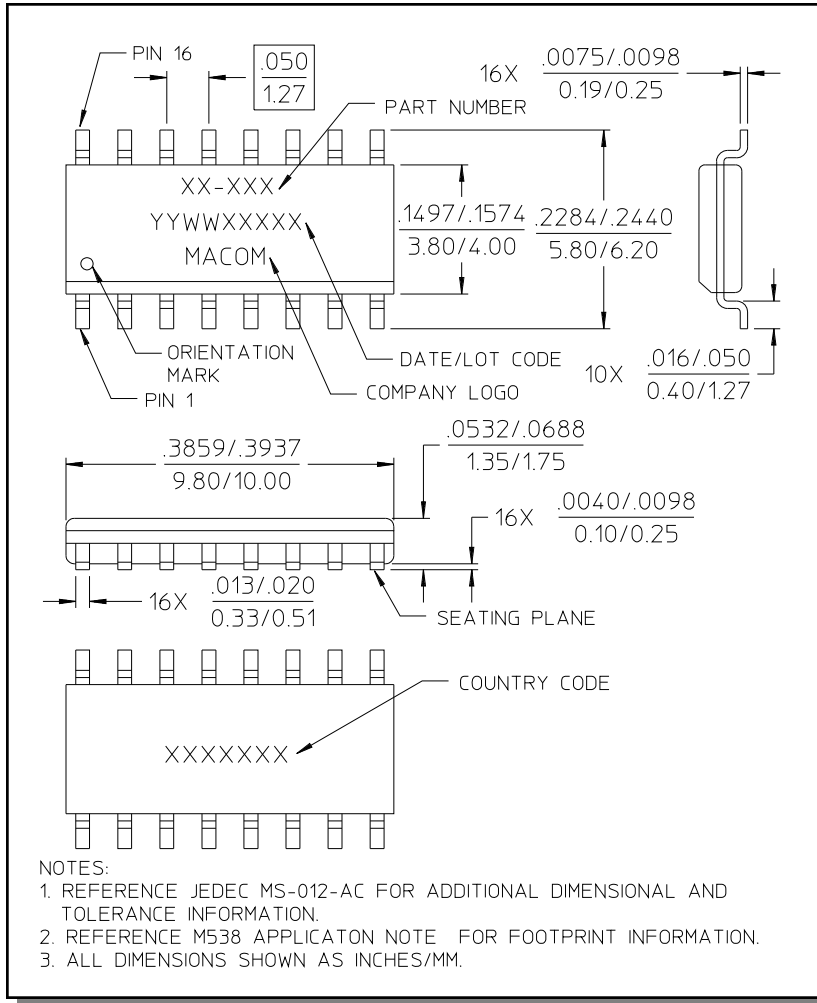

[†] Reference Application Note M538 for lead-free solder reflow recommendations.