

2 Way 0° Power Divider
5 to 1000 MHz

M/A-COM Products
Released, Rev. V1

Features

- Surface mount
- 2 Way 0 degree.
- 260°C reflow compatible
- RoHS* compliant
- Available on tape and reel.

Description

M/A Com's MAPDCT0013 is a 2 way 0 degree RF power divider in a low cost, surface mount package. Ideally suited for high volume CATV/broadband applications. Two 0603 0.5pF capacitors and one 160Ω resistor are required with this part.

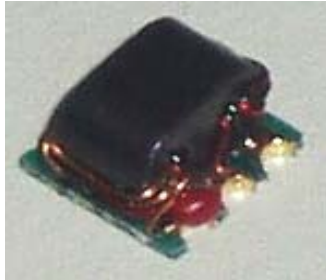

Schematic with off-chip components

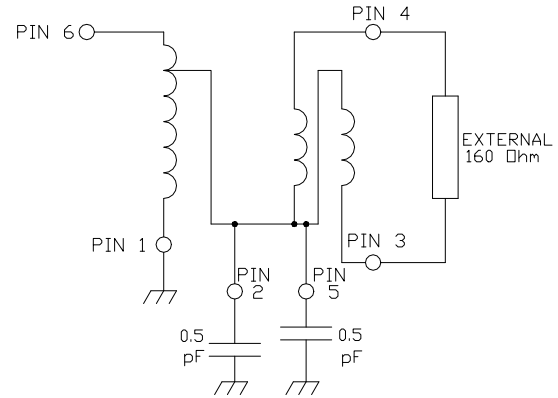

Case style: SM-156

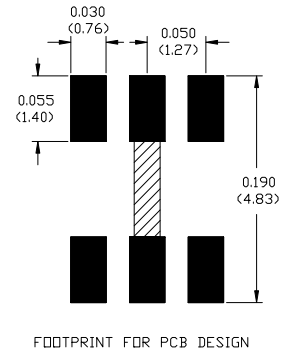
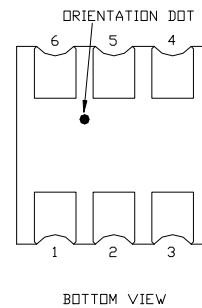
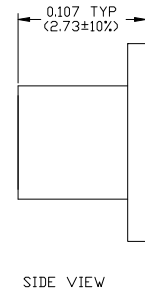
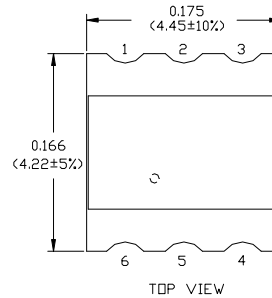

Pin configuration

Pin no.	Function
1	Ground
2	External 0.5pF Capacitor to ground
3	Output 2
4	Output 1
5	External 0.5pF Capacitor to ground
6	Input

Ordering information

Part number	Description
MAPDCT0013TR	Reel quantity 2000
MAPD-007999-CT13TB	Customer Test Board

Unless otherwise stated dimensions are in inches [mm]
Tolerance: .xx ± .02, .xxx ± .010

Note: Pin's 2 and 5 need to be connected together on the PCB as shown above.

* Restrictions on Hazardous Substances, European Union Directive 2002/95/EC.

Note: Reference Application Note **M513** for reel size information.

ADVANCED: Data Sheets contain information regarding a product M/A-COM Technology Solutions is considering for development. Performance is based on target specifications, simulated results, and/or prototype measurements. Commitment to develop is not guaranteed.

PRELIMINARY: Data Sheets contain information regarding a product M/A-COM Technology Solutions has under development. Performance is based on engineering tests. Specifications are typical. Mechanical outline has been fixed. Engineering samples and/or test data may be available. Commitment to produce in volume is not guaranteed.

• **North America** Tel: 800.366.2266 • **Europe** Tel: +353.21.244.6400
• **India** Tel: +91.80.4155721 • **China** Tel: +86.21.2407.1588

Visit www.macomtech.com for additional data sheets and product information.

M/A-COM Technology Solutions Inc. and its affiliates reserve the right to make changes to the product(s) or information contained herein without notice.

Electrical specifications: $T_A = 25^\circ\text{C}$, $Z_0 = 75\Omega$

Frequency Range	Test Conditions	Units	Nominal	Max
Insertion Loss 1 Pin 6 to 4	5 – 500 MHz	dB	0.2	0.6
	500 – 870 MHz	dB	0.7	1.3
	870 – 1000 MHz	dB	1.15	1.6
Insertion Loss 2 Pin 6 to 3	5 – 500 MHz	dB	0.25	0.6
	500 – 870 MHz	dB	0.6	1.3
	870 – 1000 MHz	dB	1.3	2.1
Amplitude Balance	5 – 870 MHz	dB	0.2	± 0.5
	870 – 1000 MHz	dB	0.15	± 0.65
Phase Balance	5 – 870 MHz	$^\circ$	1.5	± 2.4
	870 – 1000 MHz	$^\circ$	1.5	± 4.2
Input Return Loss	5 – 400 MHz	dB	36	24
	400 – 820 MHz	dB	32	20
	820 – 1000 MHz	dB	25	15
Isolation	5 – 300 MHz	dB	33	25
	300 – 870 MHz	dB	20	16
	870 – 1000 MHz	dB	18	15
Output Return Loss 1	5 – 500 MHz	dB	28	20
	500 – 870 MHz	dB	19.3	14.5
	870 – 1000 MHz	dB	14.8	11.3
Output Return Loss 2	5 – 500 MHz	dB	27	20
	500 – 870 MHz	dB	21	14.5
	870 – 1000 MHz	dB	14.5	11.3

Absolute maximum ratings^{1 2}

Parameter	Absolute maximum
Max input power	1W
Internal Load Dissipation	0.125W
Operating temperature	-40°C to +85°C
Storage temperature	-40°C to +100°C

1. Exceeding any one or combination of these limits may cause permanent damage to this device.
2. M/A-COM does not recommend sustained operation near these survivability limits.

2

ADVANCED: Data Sheets contain information regarding a product M/A-COM Technology Solutions is considering for development. Performance is based on target specifications, simulated results, and/or prototype measurements. Commitment to develop is not guaranteed.

PRELIMINARY: Data Sheets contain information regarding a product M/A-COM Technology Solutions has under development. Performance is based on engineering tests. Specifications are typical. Mechanical outline has been fixed. Engineering samples and/or test data may be available. Commitment to produce in volume is not guaranteed.

• **North America** Tel: 800.366.2266 • **Europe** Tel: +353.21.244.6400
 • **India** Tel: +91.80.4155721 • **China** Tel: +86.21.2407.1588
 Visit www.macomtech.com for additional data sheets and product information.

M/A-COM Technology Solutions Inc. and its affiliates reserve the right to make changes to the product(s) or information contained herein without notice.

Typical performance curves: $T_A = 25^\circ\text{C}$, $Z_0 = 75\Omega$

Insertion loss 1: pin 6 to pin 4

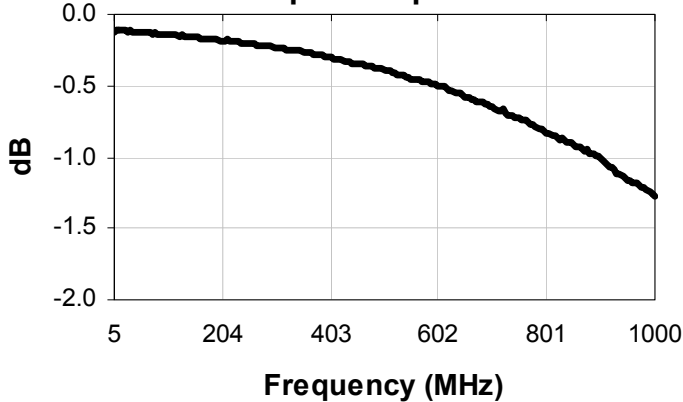

Insertion loss 2: pin 6 to pin 3

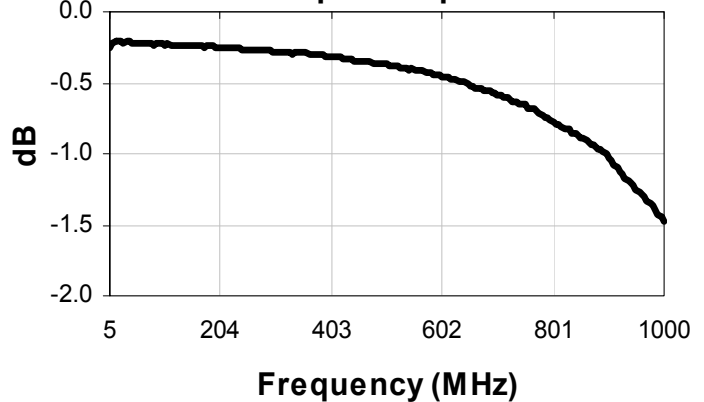

Amplitude balance

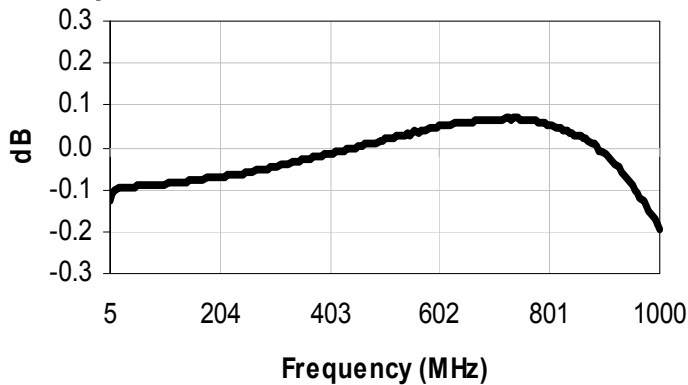

Phase balance

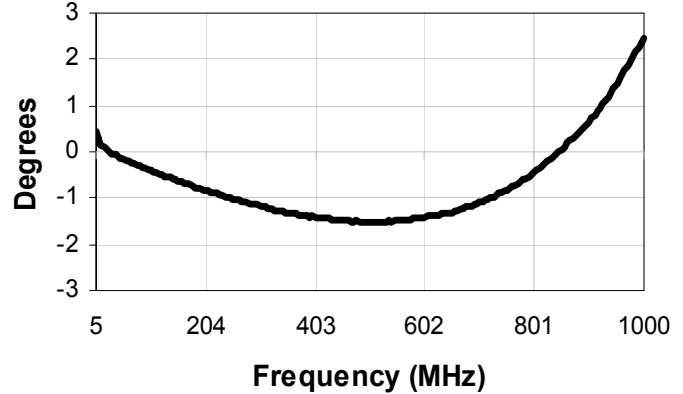

Return loss: Input

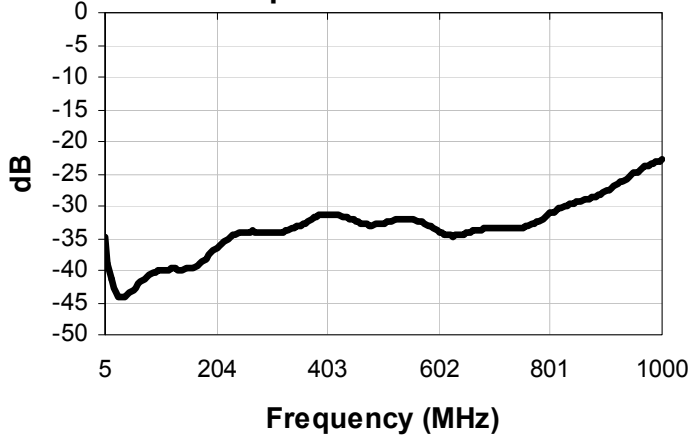

Return loss: Output (1 and 2)

