

Features

- Insertion Loss: 0.35 dB @ 1 GHz
- Lead-Free 1 mm 6-Lead PDFN Package
- Halogen-Free “Green” Mold Compound
- RoHS* Compliant and 260°C Reflow Compatible

Description

The MASW-009588 is a GaAs pHEMT MMIC single pole two throw (SP2T) switch in a miniature 1x1mm 6-lead PDFN package. The MASW-009588 is ideally suited for applications where low control voltage, low insertion loss, moderate isolation, and small size are required.

Typical applications are for filter and antenna switching in handset systems that connect separate receive functions to a common antenna, as well as other related handset and general purpose applications. This part can be used in all systems operating up to 4 GHz requiring high power at low control voltage.

The MASW-009588 is fabricated using a 0.5 micron gate length GaAs pHEMT process. The process features full passivation for performance and reliability.

Functional Diagram

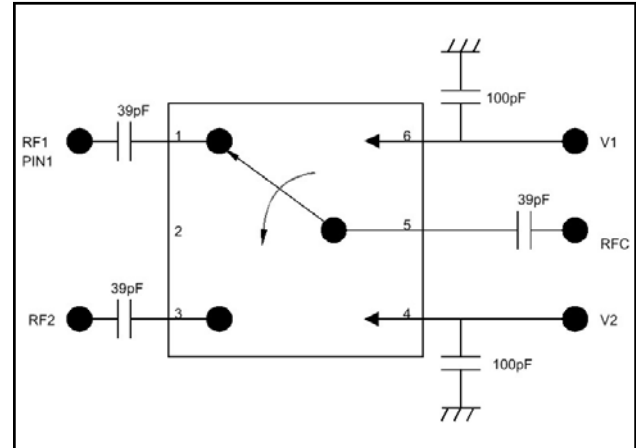

Pin Configuration

Pin No.	Function	Description
1	RF1	RF Port 1
2	GND	Ground
3	RF2	RF Port 2
4	V2	Control 2
5	RFC	RF Common
6	V1	Control 1

Ordering Information ^{1,2}

Part Number	Package
MASW-009588-000000	Bulk
MASW-009588-TR3000	3000 piece reel
MASW-009588-001SMB	Sample Board

1. Reference Application Note M513 for reel size information.
2. All sample boards include 5 loose parts.

Absolute Maximum Ratings ^{3,4}

Parameter	Absolute Maximum
Max Input Power (0.5 - 4 GHz, 2.6V Control)	+33 dBm
Operating Voltage	+5 volts
Operating Temperature	-40°C to +85°C
Storage Temperature	-65°C to +150°C

3. Exceeding any one or combination of these limits may cause permanent damage to this device.
4. M/A-COM Technology does not recommend sustained operation near these survivability limits.

* Restrictions on Hazardous Substances, European Union Directive 2002/95/EC.

1

ADVANCED: Data Sheets contain information regarding a product M/A-COM Technology Solutions is considering for development. Performance is based on target specifications, simulated results, and/or prototype measurements. Commitment to develop is not guaranteed.
PRELIMINARY: Data Sheets contain information regarding a product M/A-COM Technology Solutions has under development. Performance is based on engineering tests. Specifications are typical. Mechanical outline has been fixed. Engineering samples and/or test data may be available. Commitment to produce in volume is not guaranteed.

• **North America** Tel: 800.366.2266 • **Europe** Tel: +353.21.244.6400
 • **India** Tel: +91.80.43537383 • **China** Tel: +86.21.2407.1588
 Visit www.macomtech.com for additional data sheets and product information.

M/A-COM Technology Solutions Inc. and its affiliates reserve the right to make changes to the product(s) or information contained herein without notice.

Electrical Specifications: $T_A = 25^\circ\text{C}$, $V_C = 2.6\text{V}$, $Z_0 = 50 \Omega$ ⁵

Parameter	Test Conditions	Units	Min.	Typ.	Max.
Insertion Loss	1 GHz	dB	—	0.35	0.45
	2 GHz			0.4	0.5
	3 GHz			0.5	0.65
	4 GHz			0.6	0.75
Isolation	1 GHz	dB	23	26	—
	2 GHz		17	20	
	3 GHz		13	16	
	4 GHz		11	14	
VSWR	DC - 4 GHz	dB	—	<1.3	—
IP3	Two Tone +10 dBm, 5 MHz Spacing, >500 MHz $P_{IN} = 10 \text{ dBm}$ $V_C = 0/2.6 \text{ V}$	dBm	—	55	—
P0.1dB	$V_C = 0\text{V}/2.6\text{V}$	dBm	—	26	—
P1dB	$V_C = 0\text{V}/2.6\text{V}$	dBm	—	32	—
2nd Harmonic	1 GHz, +16 dBm	dBc	—	83	—
3rd Harmonic	1 GHz, +16 dBm	dBc	—	93	—
Trise, Tfall	10% to 90% RF, 90% to 10% RF	ns	—	15	—
Ton, Toff	50% control to 90% RF, and 50% control to 10% RF	ns	—	25	—
Transients	In Band	mV	—	30	—
Gate Leakage	$ V_C = 2.6\text{V}$	μA	—	0.2	5

5. Insertion Loss can be optimized by varying the DC Blocking Capacitor value, ie. 1000 pF for 100 - 500 MHz, 39 pF for 0.5 - 4.0 GHz

Recommended PCB

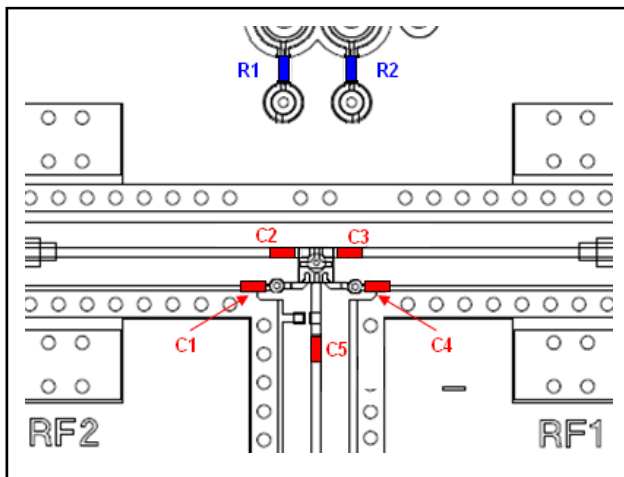

Off-Chip Component Values

Component	Value	Package
C1, C4	100 pF	0201
C2, C3, C5	39 pF	0201
R1, R2	0 Ω	0201

Truth Table ^{6,7}

V1	V2	RFC - RF1	RFC - RF2
+1.6 to 3.5 V	0 \pm 0.2 V	On	Off
0 \pm 0.2 V	+1.6 to 3.5 V	Off	On

6. External DC blocking capacitors are required on all RF ports
7. Minimum Control Voltage Delta of 1.6V required

Typical Performance Curves, $V_{CTL} = 0/+2.6 V_{DC}$

Insertion Loss

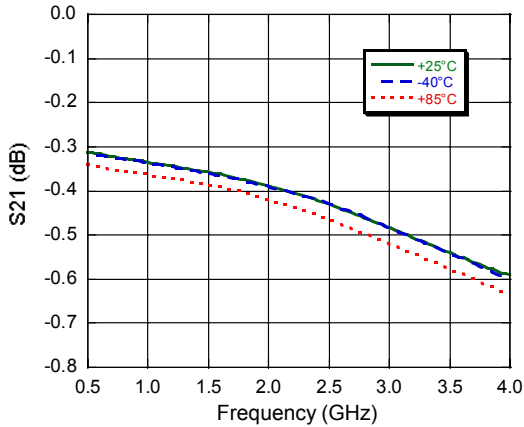

Isolation

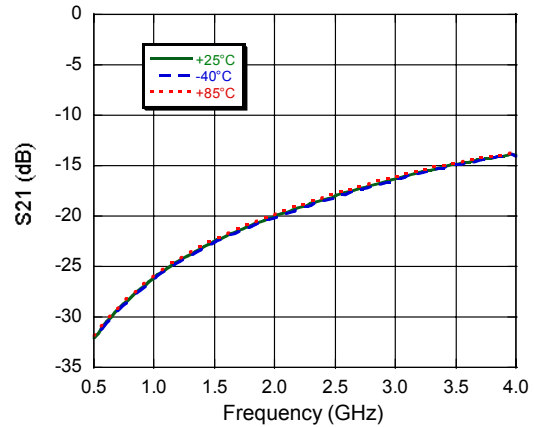

Input Return Loss

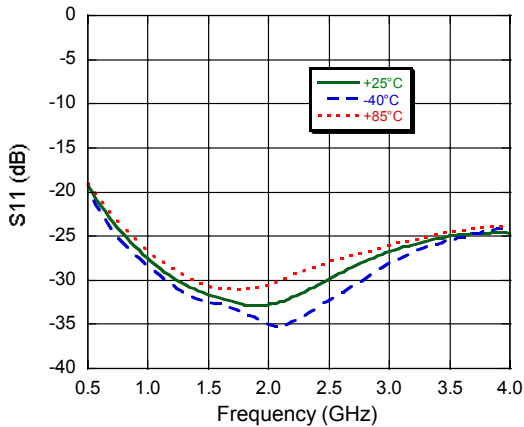

Output Return Loss

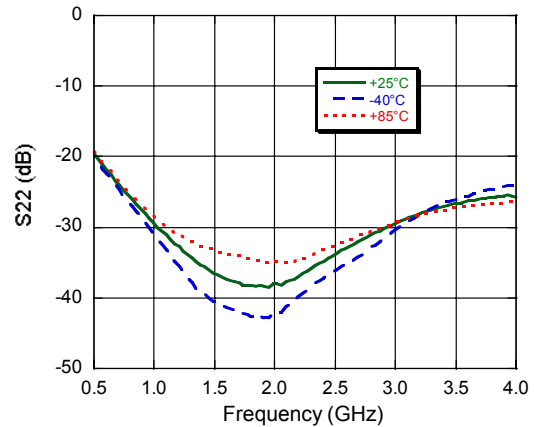

Output Power vs. Input Power @ 2.5 GHz

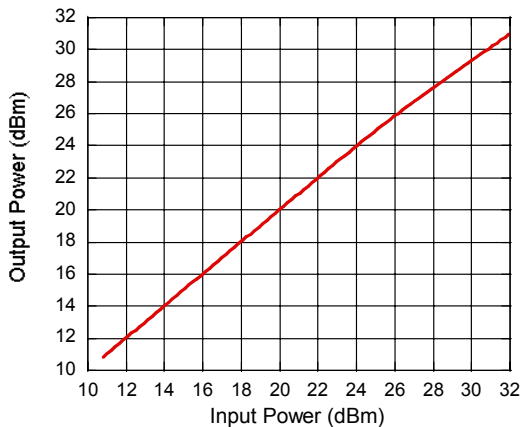

ADVANCED: Data Sheets contain information regarding a product M/A-COM Technology Solutions is considering for development. Performance is based on target specifications, simulated results, and/or prototype measurements. Commitment to develop is not guaranteed.
PRELIMINARY: Data Sheets contain information regarding a product M/A-COM Technology Solutions has under development. Performance is based on engineering tests. Specifications are typical. Mechanical outline has been fixed. Engineering samples and/or test data may be available. Commitment to produce in volume is not guaranteed.

• **North America** Tel: 800.366.2266 • **Europe** Tel: +353.21.244.6400
 • **India** Tel: +91.80.43537383 • **China** Tel: +86.21.2407.1588
 Visit www.macomtech.com for additional data sheets and product information.

M/A-COM Technology Solutions Inc. and its affiliates reserve the right to make changes to the product(s) or information contained herein without notice.

