



TIN CAN AVALANCHE AUTOMOTIVE RECTIFIER

TRA30M

AVALANCHE VOLTAGE 37 to 41 Volts

CURRENT 30 Amperes

Technical Specifecation:

Features:

- High power capability
- Economical
- Avalanche Voltage: 37V to 41V
- Glass passivated chip

MECHANICAL DATA

- Case: Tin Can
- Epoxy: UL94-0 rate flame ratardant
- Polarity: the glass is blue (Positive)
the glass is white (Negative)
- Technology vacuum soldered
- Lead: Plated slug, solderable per MIL-STD-202E
Method 208C
- Weight: 0.09 ounce, 2.57 Grams

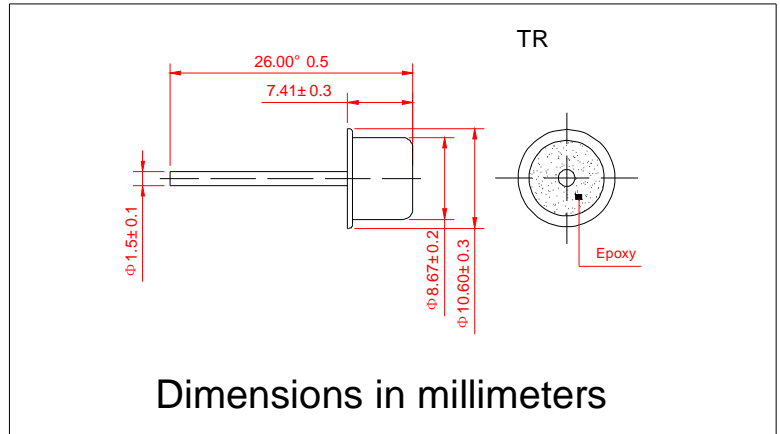

MAXIMUM RATINGS AND ELECTRICAL CHARACTERISTICS

- Ratings at 25°C ambient temperature unless otherwise specified
- Single Phase, half wave, 60Hz, resistive or inductive load
- For capacitive load derate current by 20%

Electrical Characteristics @ 25°C	SYMBOLS	MIN	NOMINAL	MAX	UNITS
Peak Repetitive Reverse Voltage	V_{RRM}		28		Volts
Working Peak Reverse Voltage	V_{RRM}		28		
DC Blocking Voltage	V_{DC}		28		
Average Rectified Forward Current ($T_c=125^\circ\text{C}$)	I_o		30		Amps
Repetitive Peak Reverse Surge Current $T_c=10\text{msec}$ Dury Cycle < 1%	I_{RSM}		30		Amps
Breakdown Voltage ($V_{br}@i_r=100\text{mA}$, $T_c=25^\circ\text{C}$) $i_r=90\text{Amps}$, $T_c=150^\circ\text{C}$, $PW=80\text{usec}$	V_{br1}	37	39	41	Volts
	V_{br2}			54	Volts
Forward Voltage Drop @ $I_f=100\text{Amps}$ < 300usec	V_F		1.05	1.08	Volts
Peak Forward Surge Current	I_{FSM}		400		Amps
Reverse Leakage ($V_R=17\text{Vdc}$) $T_A=25^\circ\text{C}$	I_R		1.0	2.0	uAmps
Operating and Storage Junction Temperature Range	T_J, T_{STG}		-65 to +175		°C

Notes: 1. Enough heatsink must be considered in application.

