

FG2000FX-50DA

HIGH POWER INVERTER USE
PRESS PACK TYPE

FG2000FX-50DA



- ITQRM Repetitive controllable on-state current 2200A
- IT(AV) Average on-state current 1050A
- VDRM Repetitive peak off state voltage 2500V
- Anode short type

OUTLINE DRAWING

Dimensions in mm

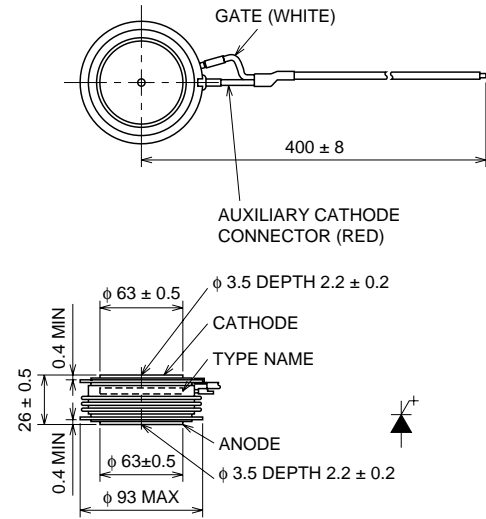

APPLICATION

Inverters, D.C. choppers, Induction heaters, D.C. to D.C. converters.

www.BDTIC.com/MITSUBISHI

MAXIMUM RATINGS

Symbol	Parameter	Voltage class		Unit
		50DA		
VRRM	Repetitive peak reverse voltage	17		V
VRSM	Non-repetitive peak reverse voltage	17		V
VR(DC)	DC reverse voltage	17		V
VDRM	Repetitive peak off-state voltage*	2500		V
VD SM	Non-repetitive peak off-state voltage*	2500		V
VD(DC)	DC off-state voltage*	2000		V

* : VGK = -2V

Symbol	Parameter	Conditions	Ratings	Unit
ITQRM	Repetitive controllable on-state current	V _{DM} = 1875V, T _j = 125°C, C _s = 4.0μF, L _s = 0.3μH	2200	A
IT(RMS)	RMS on-state current		1650	A
IT(AV)	Average on-state current	f = 60Hz, sine wave θ = 180°, T _r = 73°C	1050	A
ITSM	Surge (non-repetitive) on-state current	One half cycle at 60Hz	16	kA
I ² t	Current-squared, time integration	One cycle at 60Hz	10.5 × 10 ⁵	A ² s
diT/dt	Critical rate of rise of on-state current	V _D = 1250V, I _{GM} = 30A, T _j = 125°C	1000	A/μs
VFGM	Peak forward gate voltage		10	V
VRGM	Peak reverse gate voltage		17	V
IFGM	Peak forward gate current		100	A
IRGM	Peak gate reverse current		650	A
PFGM	Peak forward gate power dissipation		280	W
PRGM	Peak reverse gate power dissipation		18	kW
PFG(AV)	Average forward gate power dissipation		50	W
PRG(AV)	Average reverse gate power dissipation		150	W
T _j	Junction temperature		-40 ~ +125	°C
T _{stg}	Storage temperature		-40 ~ +150	°C
—	Mounting force required	Recommended value 20	18 ~ 24	kN
—	Weight	Standard value	760	g

FG2000FX-50DA

HIGH POWER INVERTER USE
PRESS PACK TYPE

ELECTRICAL CHARACTERISTICS

Symbol	Parameter	Test conditions	Limits			Unit
			Min	Typ	Max	
V _{TM}	On-state voltage	T _j = 125°C, I _{TM} = 2000A, Instantaneous measurement	—	—	2.4	V
I _{RRM}	Repetitive peak reverse current	T _j = 125°C, V _{RRM} Applied	—	—	50	mA
I _{DRM}	Repetitive peak off-state current	T _j = 125°C, V _{DRM} Applied, V _{GK} = -2V	—	—	50	mA
I _{RG}	Reverse gate current	T _j = 125°C, V _{RG} = 17V	—	—	50	mA
dv/dt	Critical rate of rise of off-state voltage	T _j = 125°C, V _D = 1250V, V _{GK} = -2V	1000	—	—	V/μs
t _{gt}	Turn-on time	T _j = 125°C, I _{TM} = 2200A, I _{GM} = 30A, V _D = 1250V	—	—	10	μs
t _{gq}	Turn-off time	T _j = 125°C, I _{TM} = 2200A, V _{DM} = 1875V, di _{GQ} /dt = -30A/μs V _{RG} = 17V, C _s = 4.0μF, L _s = 0.3μH	—	—	30	μs
I _{GQM}	Peak gate turn-off current		—	610	—	A
V _{GT}	Gate trigger voltage	DC METHOD : V _D = 24V, R _L = 0.1Ω, T _j = 25°C	—	—	1.5	V
I _{GT}	Gate trigger current		—	—	2500	mA
R _{th(j-f)}	Thermal resistance	Junction to fin	—	—	0.017	°C/W

PERFORMANCE CURVES

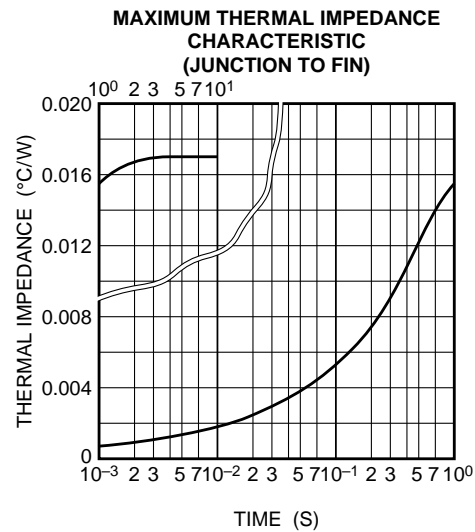
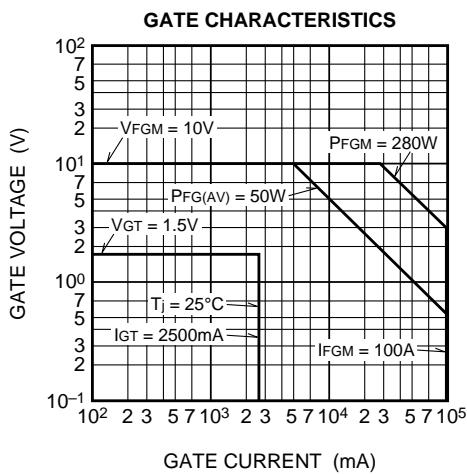
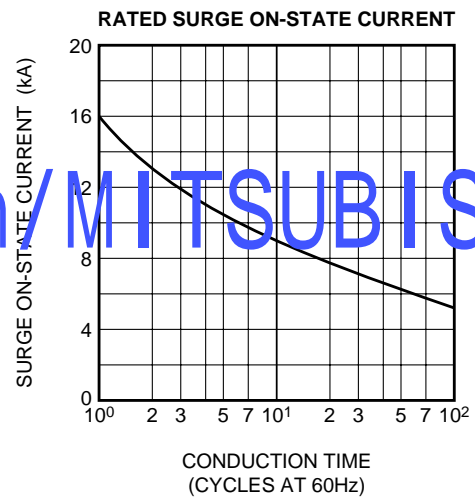
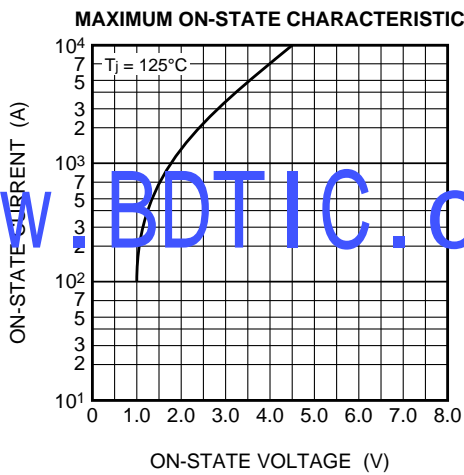

FG2000FX-50DA

HIGH POWER INVERTER USE
PRESS PACK TYPE

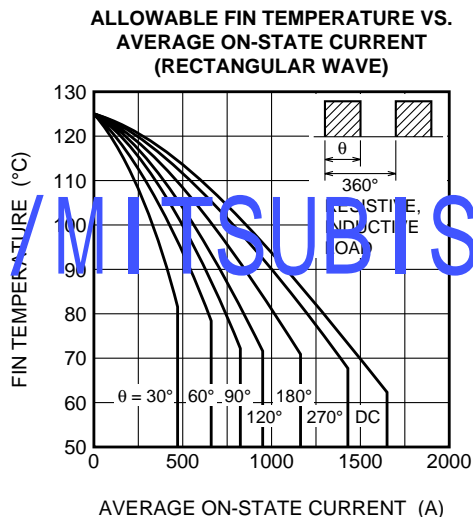
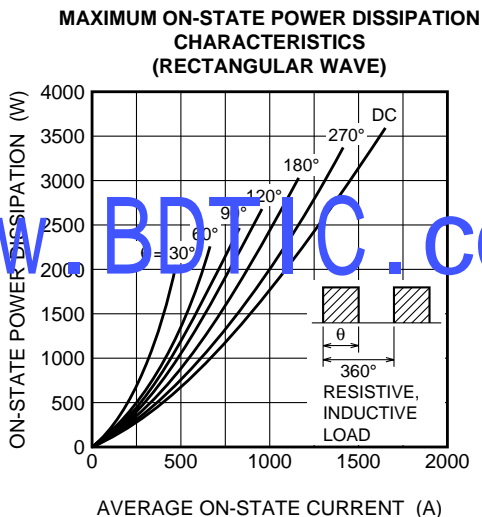
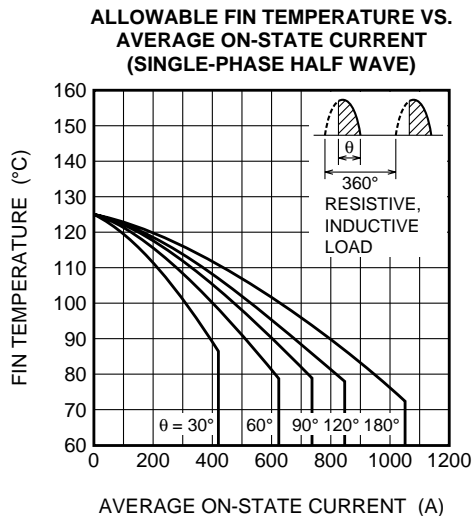
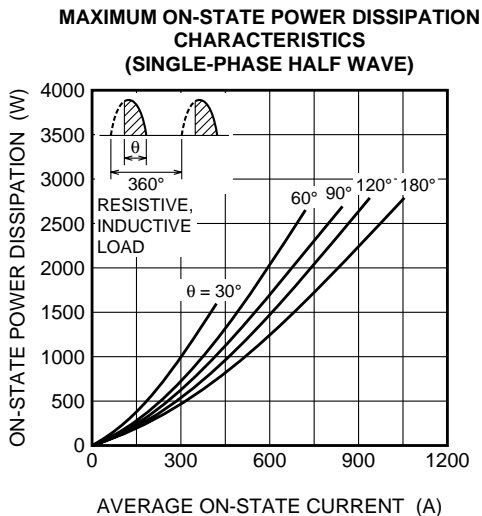

www.BDTIC.com/MITSUBISHI

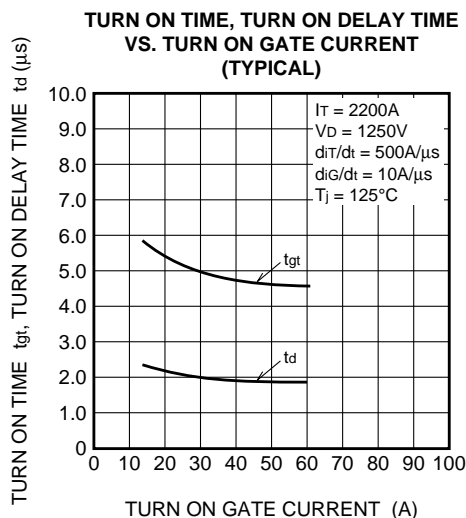
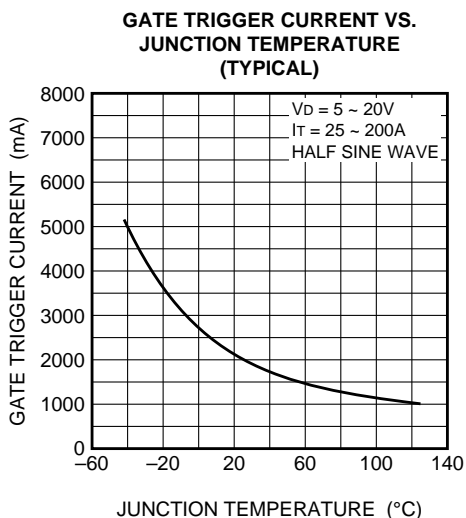

FG2000FX-50DA

HIGH POWER INVERTER USE
PRESS PACK TYPE

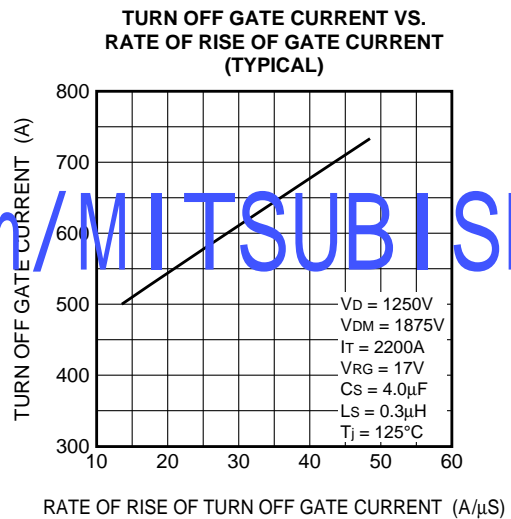
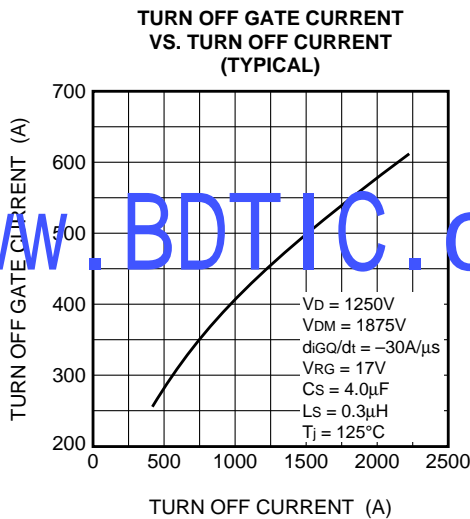
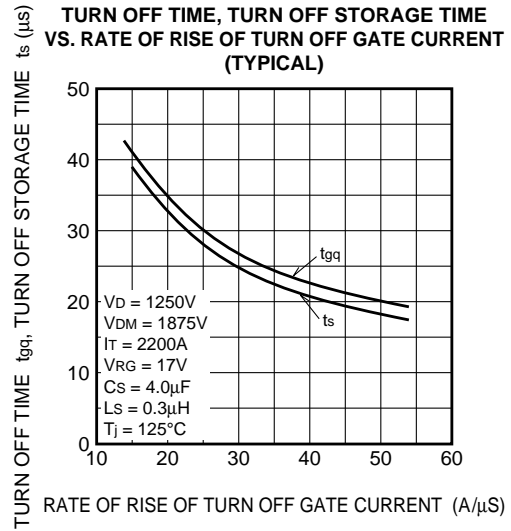
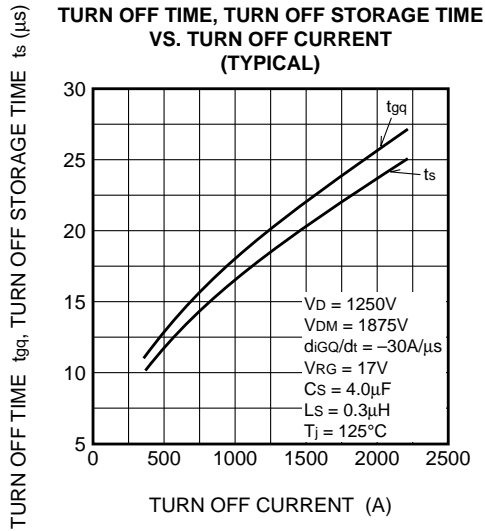

www.BDTIC.com/MITSUBISHI

