

FG3000DV-90DA

HIGH POWER INVERTER USE
PRESS PACK TYPE

FG3000DV-90DA



- ITQRM Repetitive controllable on-state current 3000A
- IT(AV) Average on-state current 950A
- VDRM Repetitive peak off state voltage 4500V
- Anode short type

OUTLINE DRAWING

Dimensions in mm

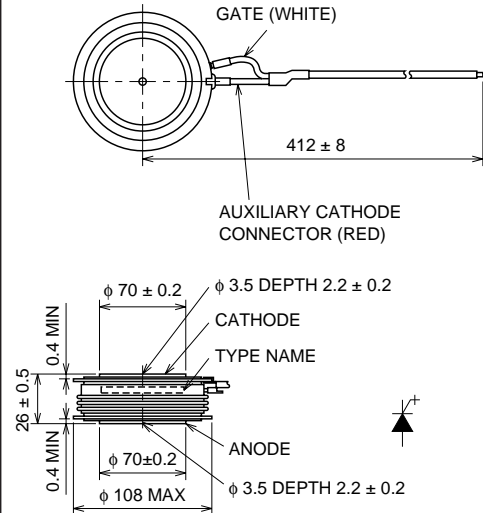

APPLICATION

Inverters, D.C. choppers, Induction heaters, D.C. to D.C. converters.

www.BDTIC.com/MITSUBISHI

MAXIMUM RATINGS

Symbol	Parameter	Voltage class		Unit
		90DA		
VRRM	Repetitive peak reverse voltage	17		V
VRSM	Non-repetitive peak reverse voltage	17		V
VR(DC)	DC reverse voltage	17		V
VDRM	Repetitive peak off-state voltage*	4500		V
VD(SM)	Non-repetitive peak off-state voltage*	4500		V
VD(DC)	DC off-state voltage*	2500		V

* : VGK = -2V

Symbol	Parameter	Conditions	Ratings	Unit
ITQRM	Repetitive controllable on-state current	V _{DM} = 3375V, T _j = 125°C, C _s = 6.0μF, L _s = 0.3μH	3000	A
IT(RMS)	RMS on-state current		1490	A
IT(AV)	Average on-state current	f = 60Hz, sine wave θ = 180°, T _r = 71°C	950	A
ITSM	Surge (non-repetitive) on-state current	One half cycle at 60Hz	17	kA
I ² t	Current-squared, time integration	One cycle at 60Hz	1.2 × 10 ⁶	A ² s
di/dt	Critical rate of rise of on-state current	V _D = 2250V, I _{GM} = 40A, T _j = 125°C	500	A/μs
VFGM	Peak forward gate voltage		10	V
VRGM	Peak reverse gate voltage		17	V
IFGM	Peak forward gate current		100	A
IRGM	Peak gate reverse current		900	A
PFGM	Peak forward gate power dissipation		400	W
PRGM	Peak reverse gate power dissipation		27	kW
PFG(AV)	Average forward gate power dissipation		100	W
PRG(AV)	Average reverse gate power dissipation		230	W
T _j	Junction temperature		-40 ~ +125	°C
T _{stg}	Storage temperature		-40 ~ +150	°C
—	Mounting force required	Recommended value 33	30 ~ 40	kN
—	Weight	Standard value	1220	g

FG3000DV-90DA

HIGH POWER INVERTER USE
PRESS PACK TYPE

ELECTRICAL CHARACTERISTICS

Symbol	Parameter	Test conditions	Limits			Unit
			Min	Typ	Max	
V _{TM}	On-state voltage	T _j = 125°C, I _{TM} = 3000A, Instantaneous measurement	—	—	4.0	V
I _{RRM}	Repetitive peak reverse current	T _j = 125°C, V _{RRM} Applied	—	—	300	mA
I _{DRM}	Repetitive peak off-state current	T _j = 125°C, V _{DRM} Applied, V _{GK} = -2V	—	—	150	mA
I _{RG}	Reverse gate current	T _j = 125°C, V _{RG} = 17V	—	—	300	mA
dv/dt	Critical rate of rise of off-state voltage	T _j = 125°C, V _D = 2250V, V _{GK} = -2V	1000	—	—	V/μs
t _{gt}	Turn-on time	T _j = 125°C, I _{TM} = 3000A, I _{GM} = 40A, V _D = 2250V	—	—	10	μs
t _{gq}	Turn-off time	T _j = 125°C, I _{TM} = 3000A, V _{DM} = 3375V, diGQ/dt = -40A/μs V _{RG} = 17V, C _s = 6.0μF, L _s = 0.3μH	—	—	30	μs
I _{GQM}	Peak gate turn-off current		—	670	—	A
V _{GT}	Gate trigger voltage	DC METHOD : V _D = 24V, R _L = 0.1Ω, T _j = 25°C	—	—	1.5	V
I _{GT}	Gate trigger current		—	—	4000	mA
R _{th(j-f)}	Thermal resistance	Junction to fin	—	—	0.015	°C/W

PERFORMANCE CURVES

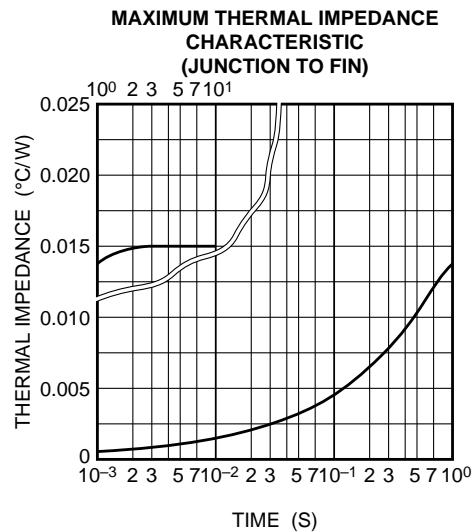
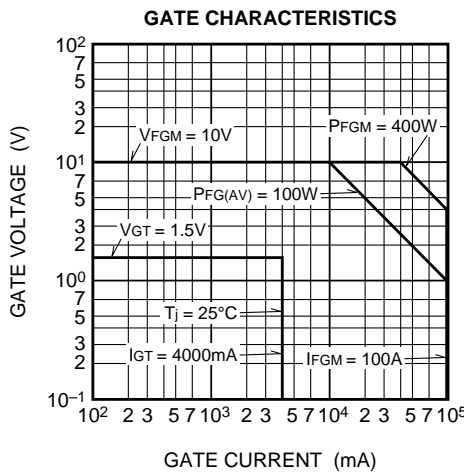
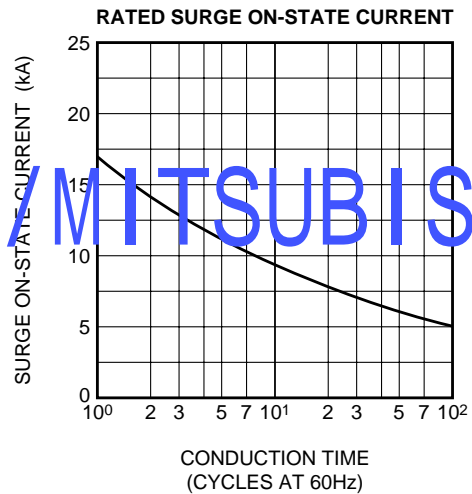
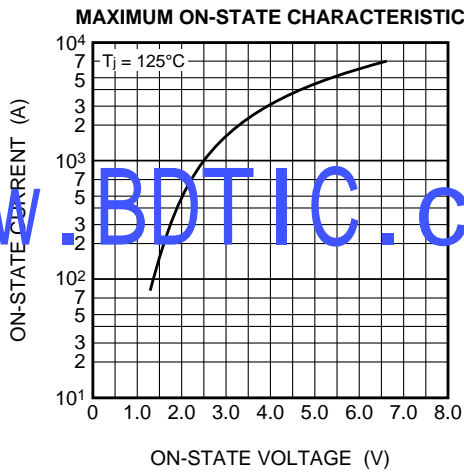

FG3000DV-90DA

HIGH POWER INVERTER USE
PRESS PACK TYPE

MAXIMUM ON-STATE POWER DISSIPATION CHARACTERISTICS (SINGLE-PHASE HALF WAVE)

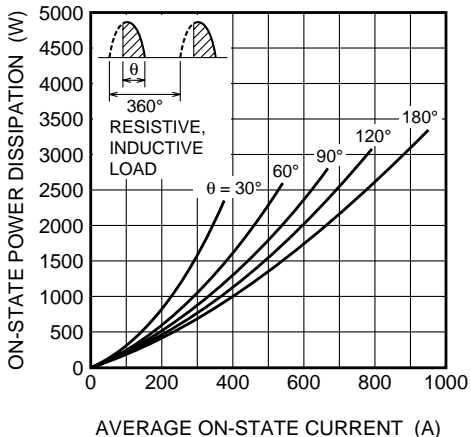

ALLOWABLE FIN TEMPERATURE VS. AVERAGE ON-STATE CURRENT (SINGLE-PHASE HALF WAVE)

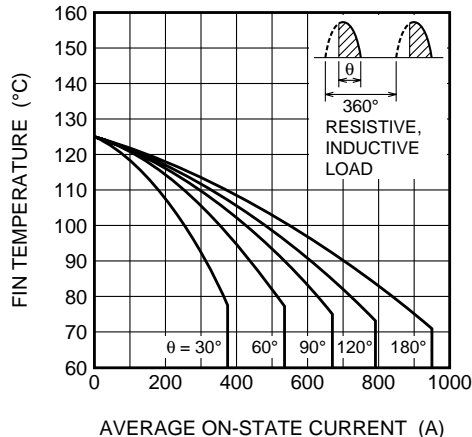

MAXIMUM ON-STATE POWER DISSIPATION CHARACTERISTICS (RECTANGULAR WAVE)

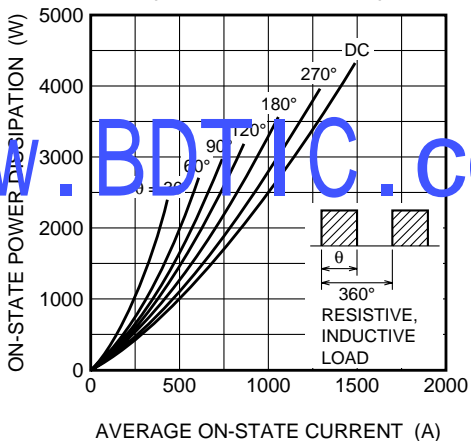

ALLOWABLE FIN TEMPERATURE VS. AVERAGE ON-STATE CURRENT (RECTANGULAR WAVE)

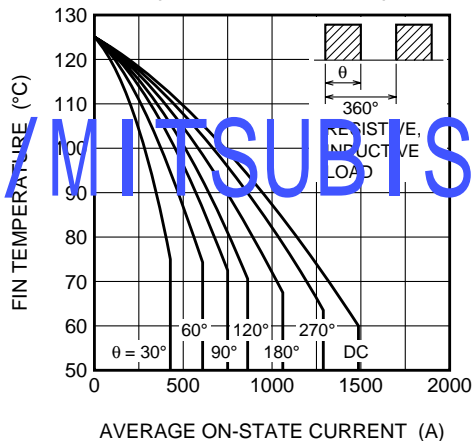

GATE TRIGGER CURRENT VS. JUNCTION TEMPERATURE (TYPICAL)

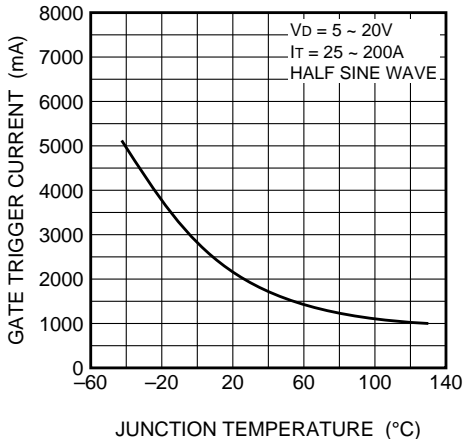

TURN ON TIME, TURN ON DELAY TIME VS. TURN ON GATE CURRENT (TYPICAL)

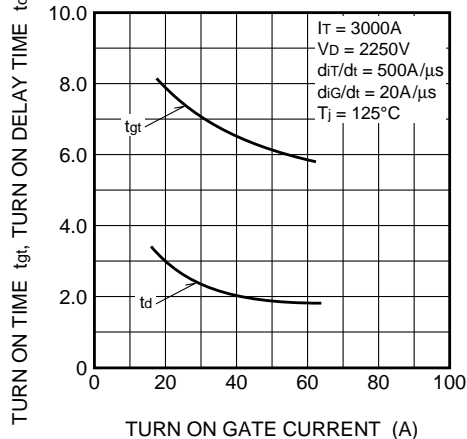

www.BDTIC.com/MITSUBISHI

FG3000DV-90DA

HIGH POWER INVERTER USE
PRESS PACK TYPE

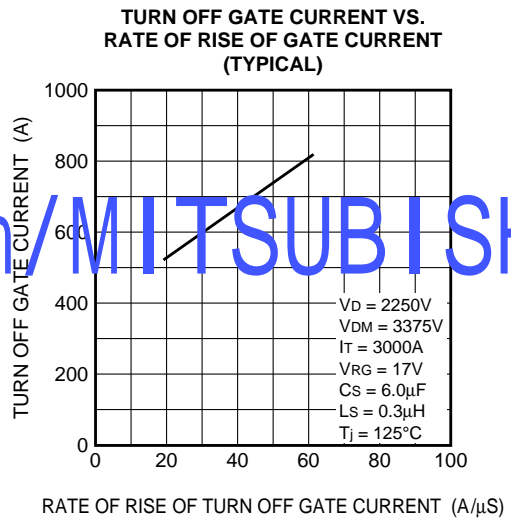
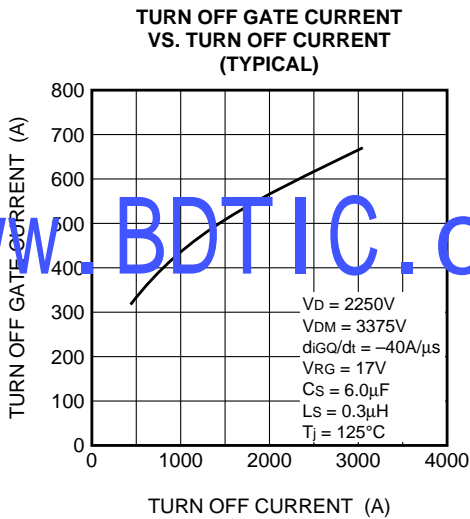
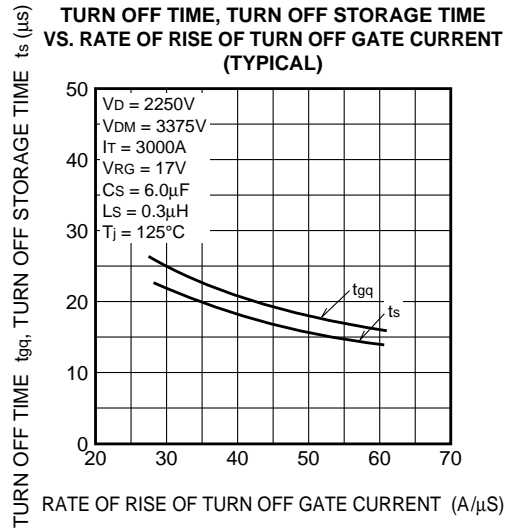
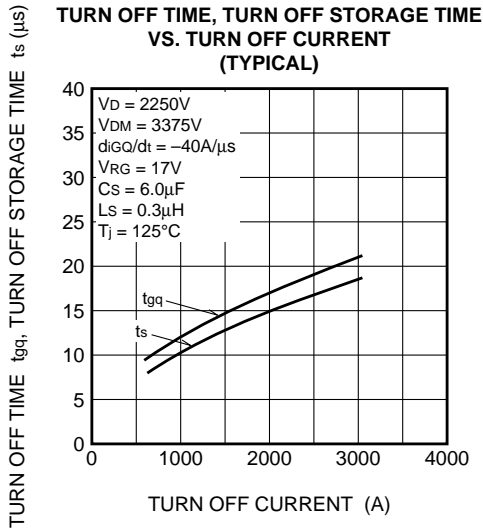

www.BDTIC.com/MITSUBISHI

