

# M54531P/FP

7-UNIT 400mA DARLINGTON TRANSISTOR ARRAY WITH CLAMP DIODE

## DESCRIPTION

M54531P and M54531FP are seven-circuit Darlington transistor arrays with clamping diodes. The circuits are made of NPN transistors. Both the semiconductor integrated circuits perform high-current driving with extremely low input-current supply.

## FEATURES

- High breakdown voltage ( $BV_{CEO} \geq 40V$ )
- High-current driving ( $I_{c(max)} = 400mA$ )
- With clamping diodes
- Driving available with PMOS IC output
- Wide input voltage range ( $V_I = -40$  to  $+40V$ )
- Wide operating temperature range ( $T_a = -20$  to  $+75^\circ C$ )

## APPLICATION

Drives of relays and printers, digit drives of indication elements (LEDs and lamps), and MOS-bipolar logic IC interfaces

[www.BDTIC.com/MITSUBISHI](http://www.BDTIC.com/MITSUBISHI)

## FUNCTION

The M54531P and M54531FP each have seven circuits consisting of NPN Darlington transistors. A serial circuit including a diode and resistance of 20kΩ is provided between input transistor bases and input pins. A spike-killer clamping diode is provided between each output pin (collector) and COM pin (pin 9). The output transistor emitters are all connected to the GND pin (pin 8).

The collector current is 400mA maximum. Collector-emitter supply voltage is 40V maximum.

The M54531FP is enclosed in a molded small flat package, enabling space-saving design.

## PIN CONFIGURATION

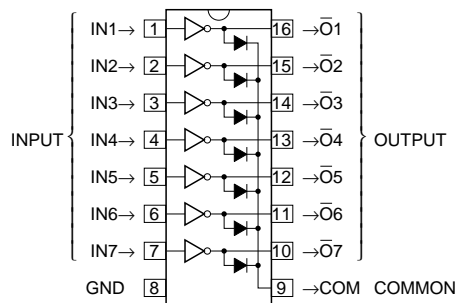

16P4(P)  
 Package type 16P2N-A(FP)

## CIRCUIT DIAGRAM

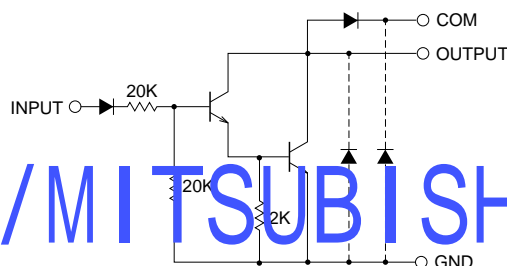

The seven circuits share the COM and GND.  
 The diode, indicated with the dotted line, is parasitic, and cannot be used.

Unit : Ω

## ABSOLUTE MAXIMUM RATINGS (Unless otherwise noted, $T_a = -20 \sim +75^\circ C$ )

Symbol	Parameter	Conditions	Ratings	Unit
$V_{CEO}$	Collector-emitter voltage	Output, H	-0.5 ~ +40	V
$I_C$	Collector current	Current per circuit output, L	400	mA
$V_I$	Input voltage		-40 ~ +40	V
$I_F$	Clamping diode forward current		400	mA
$V_R$	Clamping diode reverse voltage		40	V
$P_d$	Power dissipation	$T_a = 25^\circ C$ , when mounted on board	1.47(P)/1.00(FP)	W
$T_{opr}$	Operating temperature		-20 ~ +75	$^\circ C$
$T_{stg}$	Storage temperature		-55 ~ +125	$^\circ C$

**M54531P/FP**

7-UNIT 400mA DARLINGTON TRANSISTOR ARRAY WITH CLAMP DIODE

**RECOMMENDED OPERATING CONDITIONS** (Unless otherwise noted, Ta = -20 ~ +75°C)

Symbol	Parameter	Limits			Unit	
		min	typ	max		
Vo	Output voltage	0	—	40	V	
Ic	Collector current (Current per 1 circuit when 7 circuits are coming on simultaneously)	Duty Cycle P : no more than 8% FP : no more than 6%	0	—	400	mA
		Duty Cycle P : no more than 30% FP : no more than 25%	0	—	200	
VIH	"H" input voltage	Ic ≤ 400mA	9	—	35	V
		Ic ≤ 200mA	6	—		
VIL	"L" input voltage		0	—	1	V

**ELECTRICAL CHARACTERISTICS** (Unless otherwise noted, Ta = -20 ~ +75°C)

Symbol	Parameter	Test conditions	Limits			Unit
			min	typ*	max	
V (BR) CEO	Collector-emitter breakdown voltage	ICEO = 100μA	40	—	—	V
VCE (sat)	Collector-emitter saturation voltage	VI = 9V, Ic = 400mA	—	1.3	2.4	V
		VI = 6V, Ic = 200mA	—	1.0	1.6	
II	Input current	VI = 18V	—	1.1	1.8	mA
		VI = 35V	—	2.0	3.8	
IIR	Input reverse current	VI = -35V	—	—	-20	μA
VF	Clamping diode forward voltage	IF = 400mA	—	1.4	2.4	V
IR	Clamping diode reverse current	VR = 40V	—	—	100	μA
hFE	DC amplification factor	VCE = 4V, Ic = 300mA, Ta = 25°C	1000	3000	—	—

\*: The typical values are those measured under ambient temperature (Ta) of 25°C. There is no guarantee that these values are obtained under any conditions.

**SWITCHING CHARACTERISTICS** (Unless otherwise noted, Ta = 25°C)

Symbol	Parameter	Test conditions	Limits			Unit
			min	typ	max	
ton	Turn-on time	CL = 15pF (note 1)	—	30	—	ns
toff	Turn-off time		—	680	—	ns

**NOTE 1 TEST CIRCUIT**

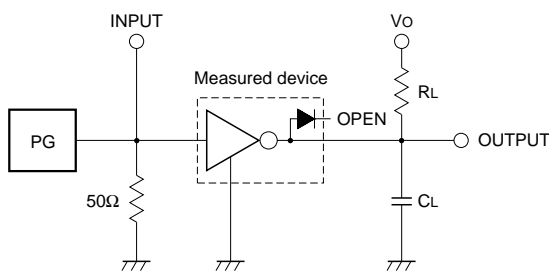

- (1) Pulse generator (PG) characteristics : PRR = 1kHz,  
tw = 10μs, tr = 6ns, tf = 6ns, Zo = 50Ω  
VP = 9VP-P
- (2) Input-output conditions : RL = 25Ω, Vo = 10V
- (3) Electrostatic capacity CL includes floating capacitance at connections and input capacitance at probes

**TIMING DIAGRAM**

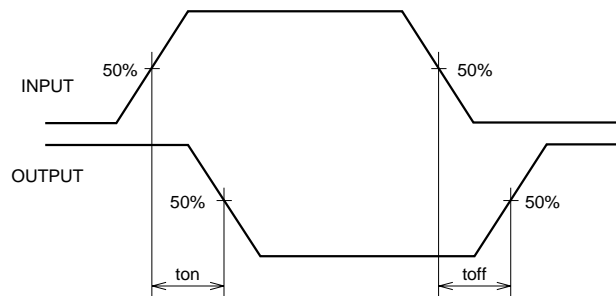

M54531P/FP

7-UNIT 400mA DARLINGTON TRANSISTOR ARRAY WITH CLAMP DIODE

TYPICAL CHARACTERISTICS

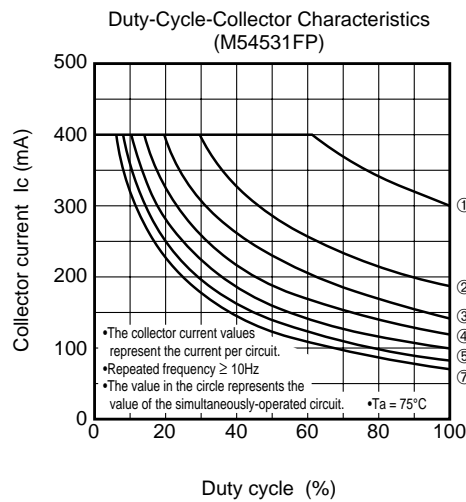
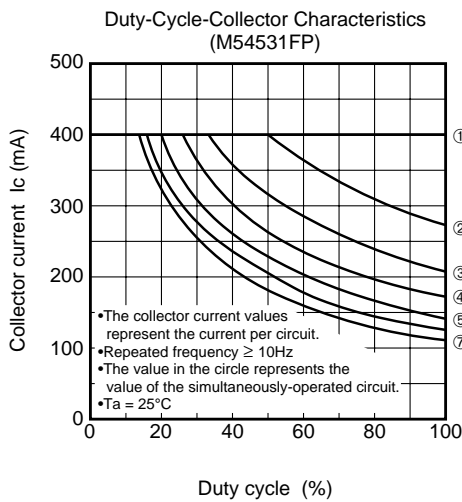
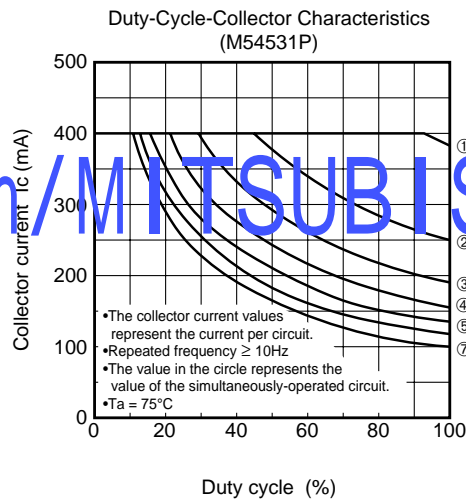
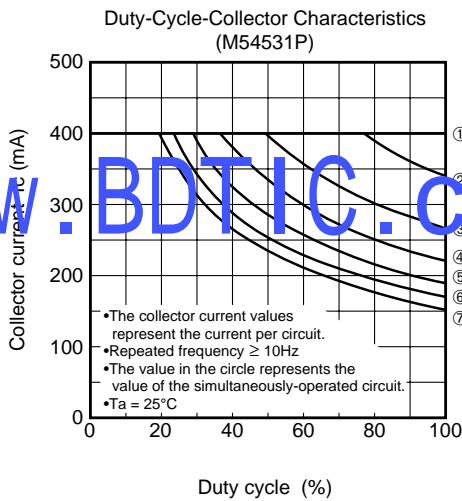
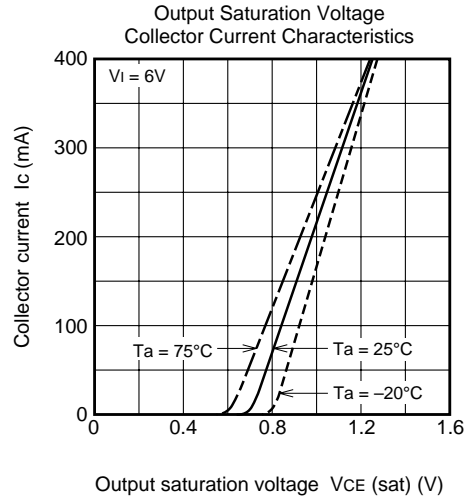
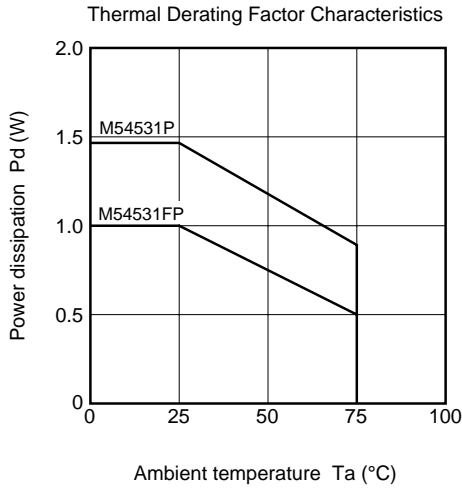

www.BDTIC.com/MITSUBISHI

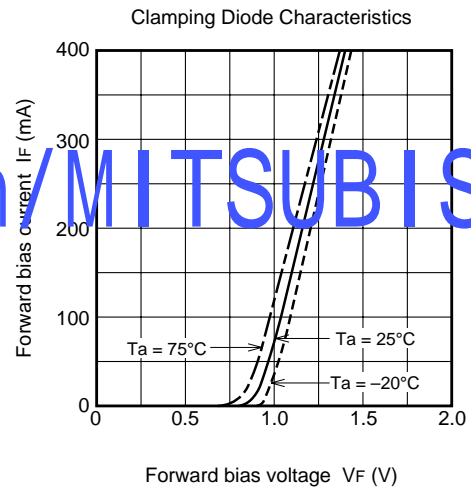
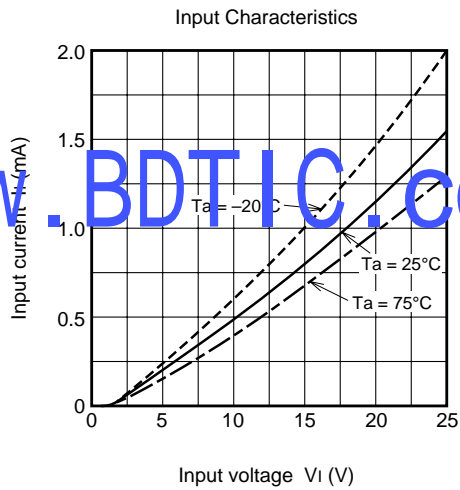
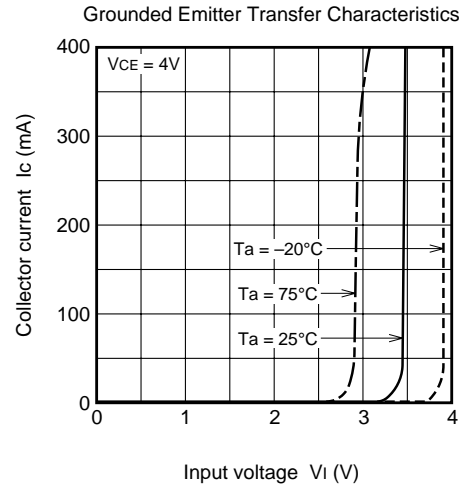
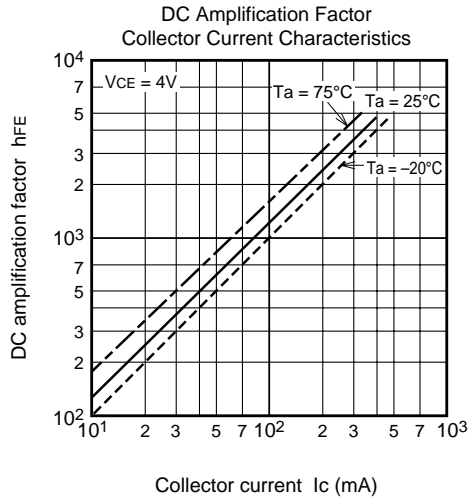

www.BDTIC.com/MITSUBISHI