

# M63800FP

7-UNIT 500mA SOURCE TYPE DARLINGTON TRANSISTOR ARRAY WITH CLAMP DIODE

## DESCRIPTION

M63800FP is a seven-circuit output-sourcing Darlington transistor array. The circuits are made of PNP and NPN transistors. This semiconductor integrated circuit performs high-current driving with extremely low input-current supply.

## FEATURES

- High breakdown voltage ( $BV_{CEO} \geq 50V$ )
- High-current driving ( $I_{O(max)} = -500mA$ )
- With output clamping diodes
- Driving available with CMOS IC output of 6-16V or with TTL output
- Wide operating temperature range ( $T_a = -20$  to  $+75^\circ C$ )
- Output current-sourcing type

## APPLICATION

Drives of relays, printers, LEDs, fluorescent display tubes and lamps, and interfaces between MOS-bipolar logic systems and relays, solenoids, or small motors

## FUNCTION

The M63800FP has seven circuits, which are made of input inverters and current-sourcing outputs. The outputs are made of PNP transistors and NPN Darlington transistors. The PNP transistor base current is constant. A spike-killer clamping diode is provided between each output pin and GND.  $V_s$  (pin 8) and GND (pin 9) are used commonly among the eight circuits.

The input has resistance of  $3k\Omega$ , and a maximum of 10V can be applied. The output current is 500mA maximum. Supply voltage  $V_s$  is 50V maximum.

The M63800FP is enclosed in a molded small flat package, enabling space-saving design.

## PIN CONFIGURATION

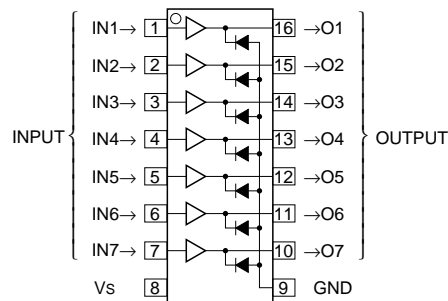

Package type 16P2N-A

## CIRCUIT DIAGRAM

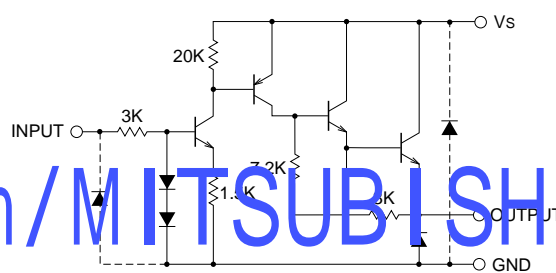

The seven circuits share the  $V_s$  and GND.  
The diode, indicated with the dotted line, is parasitic, and cannot be used.

Unit :  $\Omega$

## ABSOLUTE MAXIMUM RATINGS (Unless otherwise noted, $T_a = -20 \sim +75^\circ C$ )

Symbol	Parameter	Conditions	Ratings	Unit
$V_{CEO}$ #	Collector-emitter voltage	Output, L	-0.5 ~ +50	V
$V_s$	Supply voltage		50	V
$V_i$	Input voltage		-0.5 ~ +10	V
$I_O$	Output current	Current per circuit output, H	-500	mA
$I_F$	Clamping diode forward current		-500	mA
$V_R$ #	Clamping diode reverse voltage		50	V
$P_d$	Power dissipation	$T_a = 25^\circ C$ , when mounted on board	1.00	W
$T_{opr}$	Operating temperature		-20 ~ +75	$^\circ C$
$T_{stg}$	Storage temperature		-55 ~ +125	$^\circ C$

# : Unused I/O pins must be connected to GND.

7-UNIT 500mA SOURCE TYPE DARLINGTON TRANSISTOR ARRAY WITH CLAMP DIODE

RECOMMENDED OPERATING CONDITIONS (Unless otherwise noted, Ta = -20 ~ +75°C)

Symbol	Parameter	Limits			Unit	
		min	typ	max		
Vs	Supply voltage	0	—	50	V	
Io	Output current (Current per 1 circuit when 7 circuits are coming on simultaneously)	Duty Cycle no more than 7%	0	—	-350	mA
		Duty Cycle no more than 40%	0	—	-100	
VIH	"H" input voltage	2.4	5	10	V	
VIL	"L" input voltage	0	—	0.2	V	

ELECTRICAL CHARACTERISTICS (Unless otherwise noted, Ta = -20 ~ +75°C)

Symbol	Parameter	Test conditions	Limits			Unit
			min	typ*	max	
IS (leak) #	Supply leak current	Vs = 50V, Vi = 0.2V	—	—	100	μA
VCE (sat)	Collector-emitter saturation voltage	Vs = 10V, Vi = 2.4V, Io = -350mA	—	1.6	2.4	V
		Vs = 10V, Vi = 2.4V, Io = -100mA	—	1.45	2.0	
Ii	Input current	Vi = 3V	—	0.6	1.0	mA
		Vi = 10V	—	2.9	5.0	
IS	Supply current	Vs = 50V, Vi = 3V (all input)	—	5.6	15.0	mA
VF	Clamping diode forward voltage	IF = -350mA	—	-1.2	-2.4	V
IR #	Clamping diode reverse current	VR = 50V	—	—	100	μA

\* : The typical values are those measured under ambient temperature (Ta) of 25°C. There is no guarantee that these values are obtained under any conditions.

# : Unused I/O pins must be connected to GND.

[www.BDTIC.com/MITSUBISHI](http://www.BDTIC.com/MITSUBISHI)

SWITCHING CHARACTERISTICS (Unless otherwise noted, Ta = 25°C)

Symbol	Parameter	Test conditions	Limits			Unit
			min	typ	max	
ton	Turn-on time	CL = 15pF (note 1)	—	100	—	ns
toff	Turn-off time		—	4800	—	ns

NOTE 1 TEST CIRCUIT

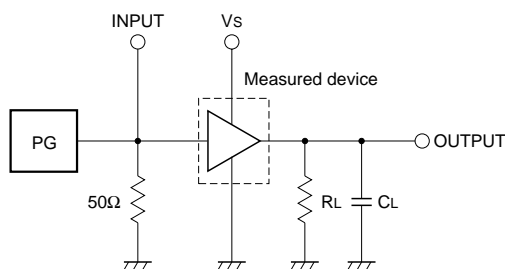

- (1) Pulse generator (PG) characteristics : PRR = 1kHz, tw = 10μs, tr = 6ns, tf = 6ns, Zo = 50Ω, Vi = 0 to 2.4V
- (2) Input-output conditions : RL = 30Ω, Vs = 10V
- (3) Electrostatic capacity CL includes floating capacitance at connections and input capacitance at probes

TIMING DIAGRAM

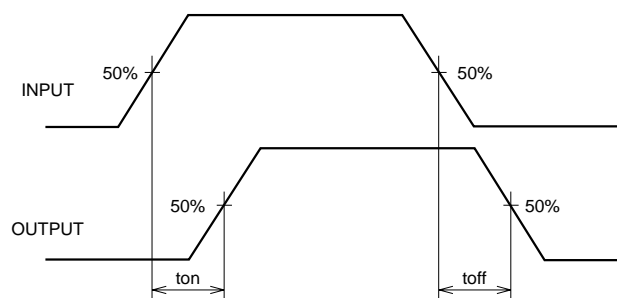

7-UNIT 500mA SOURCE TYPE DARLINGTON TRANSISTOR ARRAY WITH CLAMP DIODE

TYPICAL CHARACTERISTICS

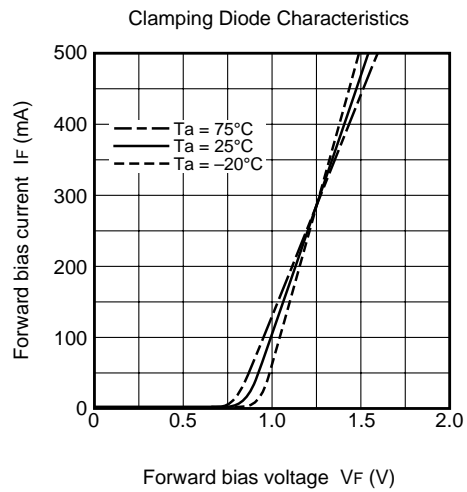
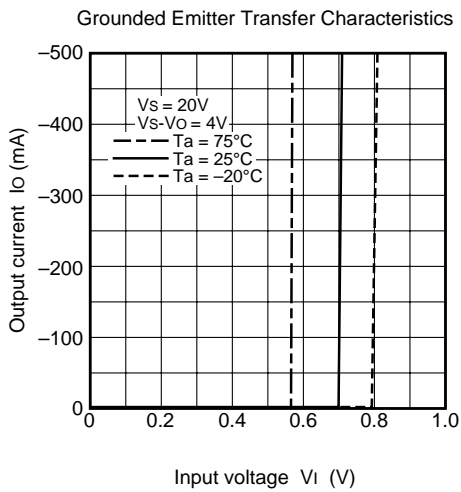
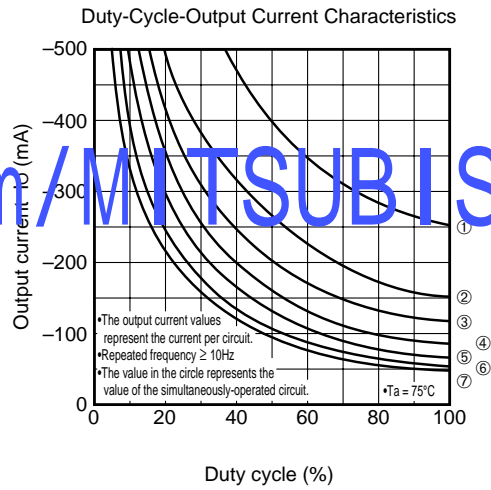
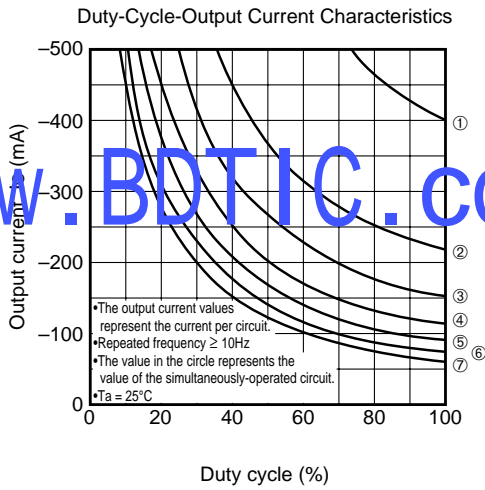
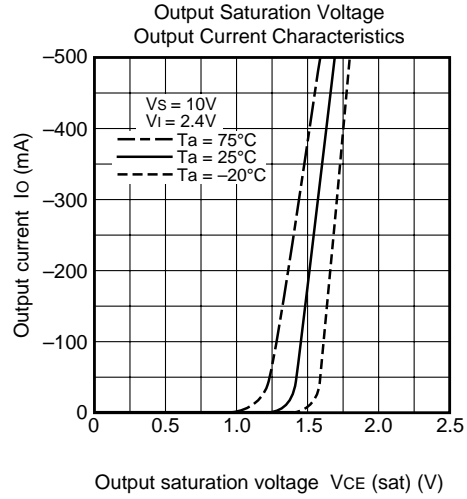
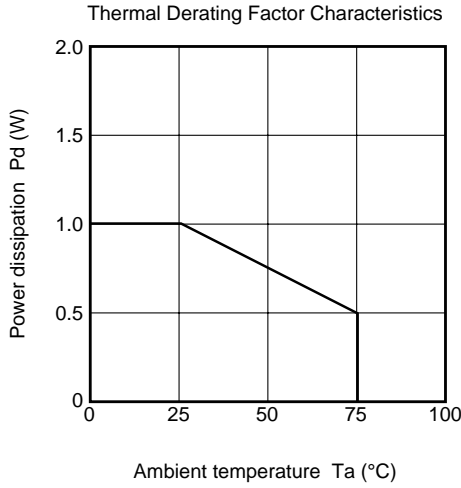

www.BDTIC.com/MITSUBISHI

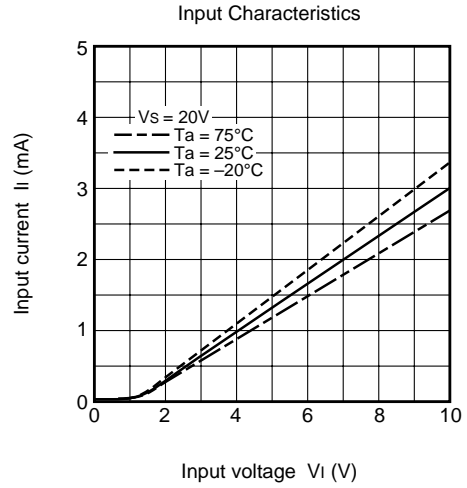
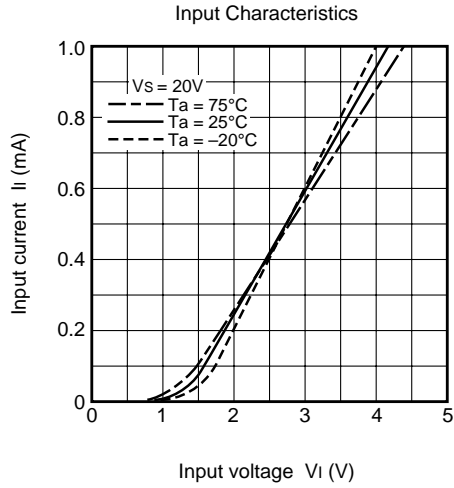

[www.BDTIC.com/MITSUBISHI](http://www.BDTIC.com/MITSUBISHI)