

PRELIMINARY
 Notice: This is not a final specification.
 Some parametric limits are subject to change.

M63834FP/KP

8-UNIT 500mA DARLINGTON TRANSISTOR-ARRAY

DESCRIPTION

The M63834FP/KP 8-channel sinkdriver, consists of 8 PNP and 16 NPN transistors connected to form eight high current gain driver pairs.

FEATURES

- High breakdown voltage ($BV_{CEO} \geq 50V$)
- High-current driving ($I_{C(max)} = 500mA$)
- 3V micro computer compatible input
- "L" active level input
- With input diode
- Wide operating temperature range ($T_a = -40$ to $+85^\circ C$)

APPLICATION

Output for 3 voltage microcomputer series and interface with high voltage system. Relay and small printer driver, LED, or incandescent display digit driver.

FUNCTION

The M63834GP/KP is transistor-array of high active level eight units which can be directly drive of 3 voltage micro-computer series. A resistor of $3.5k\Omega$ is connected between the input and the base of PNP transistors. The input diode is intended to prevent the flow of current from the input to the Vcc. Without this diode, the current flows from "H" input to the Vcc and the "L" input circuit is activated, in such a case where one of the inputs of the 8 circuit is "H" and the other are "L" to save power consumption. The diode is inserted to prevent such mis-operation. The outputs are capable of driving 500mA and are rated for operation with output voltage up to 50V.

PIN CONFIGURATION

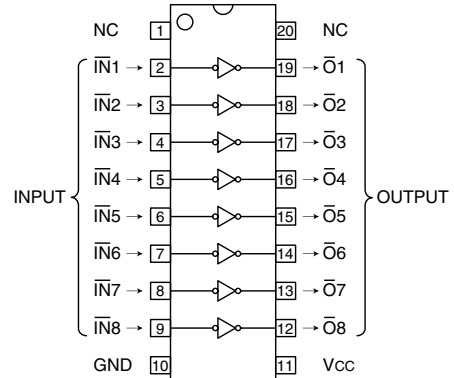

20P2N-A(FP) NC : No connection
 Package type 20P2E-A(KP)

CIRCUIT DIAGRAM

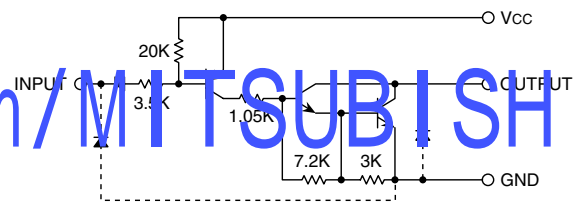

The eight circuits share the Vcc and GND
 The diode, indicated with the dotted line, is parasitic, and cannot be used.
 Unit : Ω

ABSOLUTE MAXIMUM RATINGS (Unless otherwise noted, $T_a = -40 \sim +85^\circ C$)

Symbol	Parameter	Conditions	Ratings	Unit
Vcc	Supply voltage		7	V
V _{CEO}	Collector-emitter voltage	Output, H	-0.5 ~ +50	V
I _C	Collector current	Current per circuit output, L	500	mA
V _I	Input voltage		-0.5 ~ Vcc	V
P _d	Power dissipation	T _a = 25°C, when mounted on board	1.10(FP)/0.68(KP)	W
T _{opr}	Operating temperature		-40 ~ +85	°C
T _{stg}	Storage temperature		-55 ~ +125	°C

PRELIMINARY
 Notice: This is not a final specification.
 Some parametric limits are subject to change.

RECOMMENDED OPERATING CONDITIONS (Unless otherwise noted, Ta = -40 ~ +85°C)

Symbol	Parameter	Limits			Unit	
		min	typ	max		
Vcc	Supply voltage	2.7	3.0	3.6	V	
Ic	Collector current (Current per 1 circuit when 8 circuits are coming on simultaneously)	Duty Cycle FP : no more than 4% KP : no more than 2%	0	—	400	mA
		Duty Cycle FP : no more than 15% KP : no more than 6%	0	—	200	
VIH	"H" input voltage	Vcc-0.5	—	Vcc	V	
VIL	"L" input voltage	0	—	Vcc-2.2	V	

ELECTRICAL CHARACTERISTICS (Unless otherwise noted, Ta = -40 ~ +85°C)

Symbol	Parameter	Test conditions	Limits			Unit
			min	typ*	max	
V (BR) CEO	Collector-emitter breakdown voltage	ICEO = 100µA	50	—	—	V
VCE(sat)	Collector-emitter saturation voltage	VCC = 2.7V, VI = 0.5V, IC = 400mA	—	1.15	2.4	V
		VCC = 2.7V, VI = 0.5V, IC = 200mA	—	0.93	1.6	
Ii	Input current	VI = VCC-2.2V	—	-220	-600	µA
ICC	Supply current (AN only Input)	VCC = 3.6V, VI = 0.5V	—	2.6	4.0	mA
hFE	DC amplification factor	VCC = 2.7V, VCE = 2V, IC = 0.35A, Ta = 25°C	2000	10000	—	—

* : Typical values are at Ta = 25°C

SWITCHING CHARACTERISTICS (Unless otherwise noted, Ta = 25°C)

Symbol	Parameter	Test conditions	Limits			Unit
			min	typ	max	
ton	Turn-on time	CL = 15pF (note 1)	—	120	—	ns
toff	Turn-off time		—	4500	—	

NOTE 1 TEST CIRCUIT

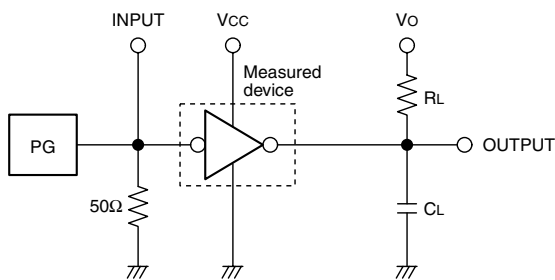

- (1) Pulse generator (PG) characteristics : PRR=1kHz,
 tw = 10µs, tr = 6ns, tf = 6ns, Zo = 50Ω
 VI = 0.5 ~ 2.7V
- (2) Input-output conditions : RL = 30Ω, Vo = 10V, Vcc = 2.7V
- (3) Electrostatic capacity CL includes floating capacitance
 at connections and input capacitance at probes

TIMING DIAGRAM

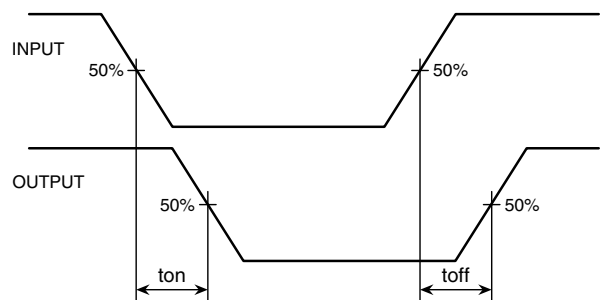

PRELIMINARY
 Notice: This is not a final specification.
 Some parametric limits are subject to change.

TYPICAL CHARACTERISTICS

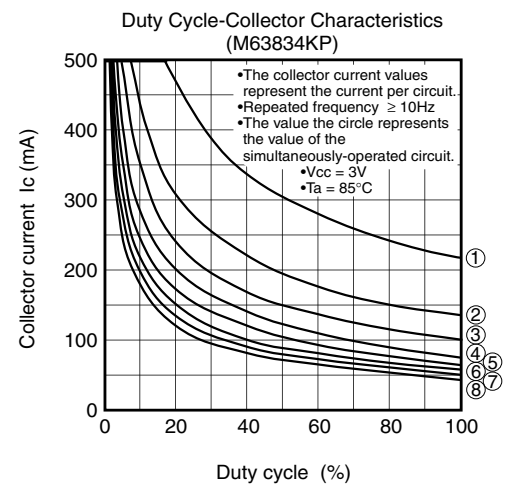
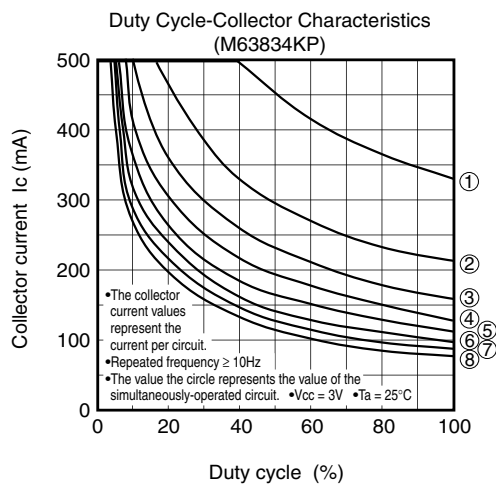
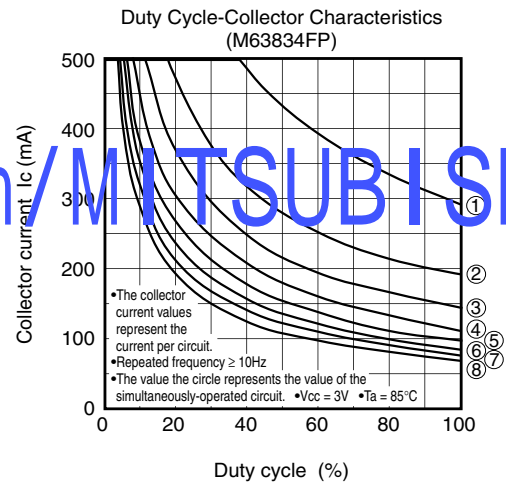
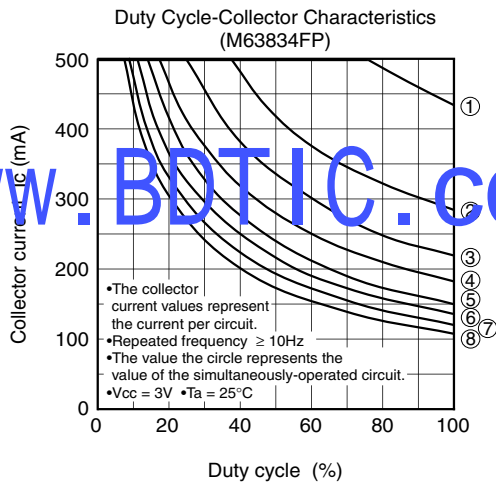
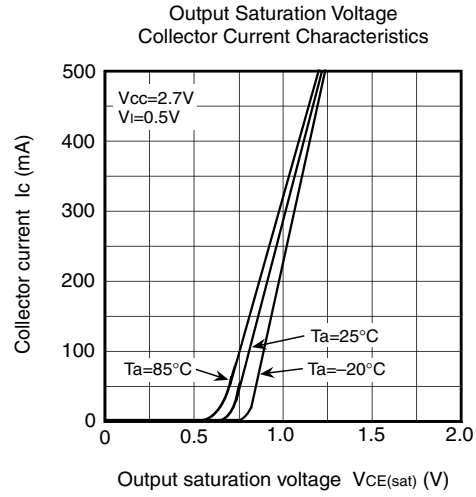
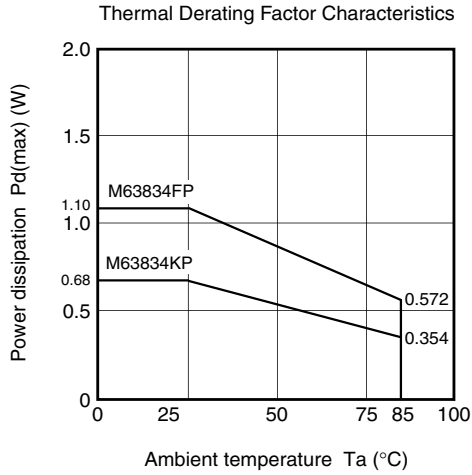

www.BDTIC.com/MITSUBISHI

PRELIMINARY
 Notice: This is not a final specification.
 Some parametric limits are subject to change.

DC Amplification Factor
 Collector Current Characteristics

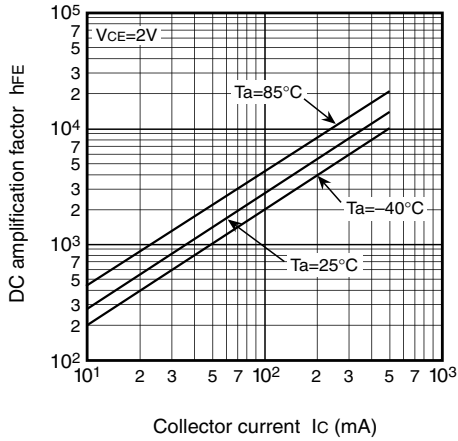

Output Current Characteristics

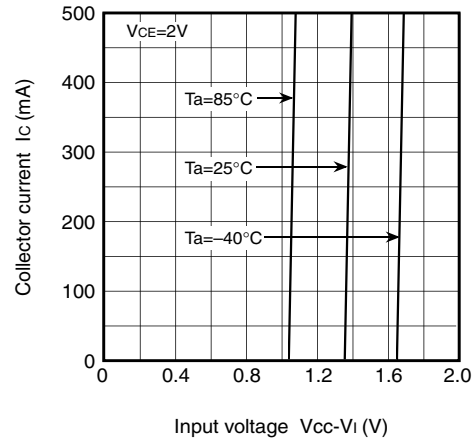

Input Characteristics

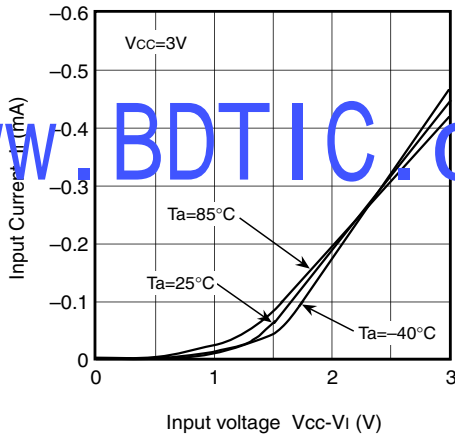

Driver Supply Characteristics

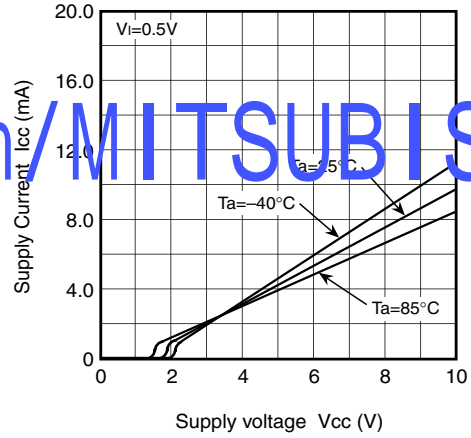

www.BDTIC.com/MITSUBISHI