

PM100CBS060

FLAT-BASE TYPE
INSULATED PACKAGE

PM100CBS060



FEATURE

- a) Adopting 4th generation IGBT chip, which performance is improved by 1 μ m fine rule process.
For example, typical $V_{ce(sat)}$ =1.7V
- b) Using new Diode which is designed to get soft reverse recovery characteristics.
- c) Over-temperature protection by detecting T_j of the IGBT chips
 - 3 ϕ 100A, 600V Current-sense IGBT type inverter
 - Monolithic gate drive & protection logic
 - Detection, protection & status indication circuits for over-current, short-circuit, over-temperature & under-voltage
 - Acoustic noise-less 11kW class inverter application

APPLICATION

Servo drives and other motor controls

PACKAGE OUTLINES

Dimensions in mm

www.BDTIC.com/MITSUBISHI

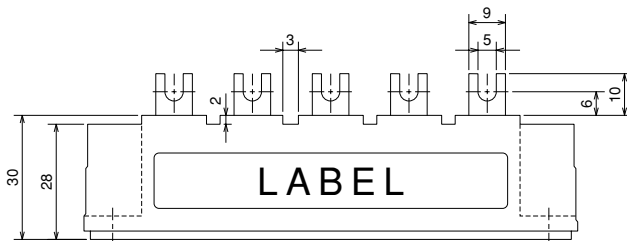
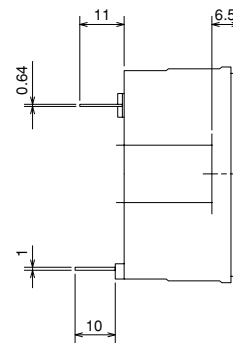
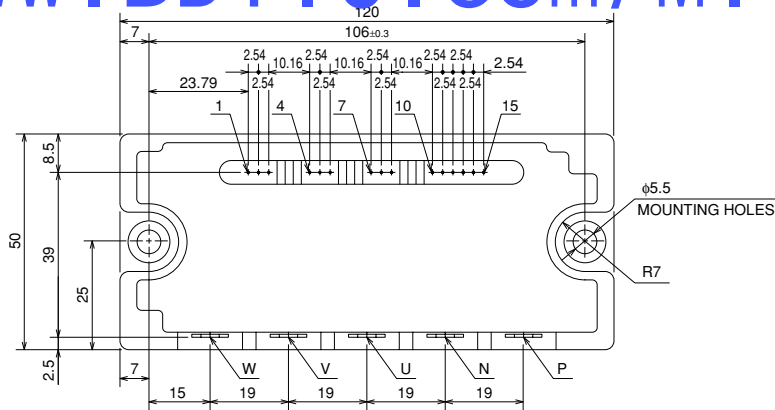

Terminal code

- | | |
|---------|---------|
| 1. VWPC | 9. VUP1 |
| 2. WP | 10. VNC |
| 3. VWP1 | 11. VN1 |
| 4. VVPC | 12. WN |
| 5. VP | 13. VN |
| 6. VVP1 | 14. UN |
| 7. VUVC | 15. Fo |
| 8. UP | |

PM100CBS060

FLAT-BASE TYPE
INSULATED PACKAGE

INTERNAL FUNCTIONS BLOCK DIAGRAM

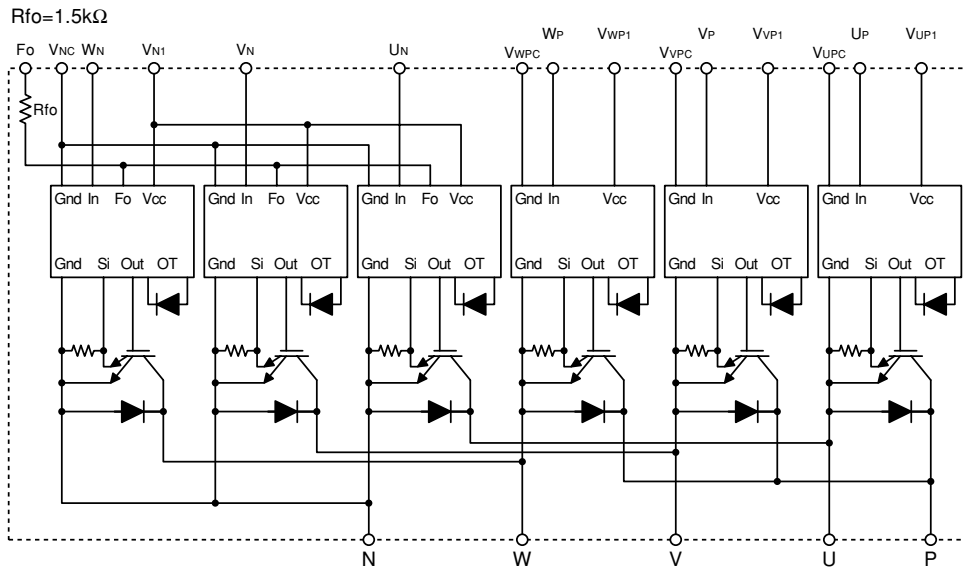

MAXIMUM RATING (Tj = 25°C unless otherwise noted)
www.BDTIC.com/MITSUBISHI

Symbol	Parameter	Conditions	Ratings	Unit
V _{CES}	Collector-Emitter Voltage	V _D = 15V, V _{CIN} = 15V	600	V
±I _C	Collector Current	T _C = 25°C	100	A
±I _{CP}	Collector Current (Peak)	T _C = 25°C	200	A
P _C	Collector Dissipation	T _C = 25°C	568	W
T _j	Junction Temperature		-20 ~ +150	°C

CONTROL PART

Symbol	Parameter	Conditions	Ratings	Unit
V _D	Supply Voltage	Applied between : V _{UP1} -V _{UPC} V _{V_{P1}} -V _{V_{PC}} , V _{WP1} -V _{W_{PC}} , V _{N1} -V _{N_C}	20	V
V _{CIN}	Input Voltage	Applied between : U _P -V _{UPC} , V _P -V _{V_{PC}} W _P -V _{W_{PC}} , U _N • V _N • W _N -V _{N_C}	20	V
V _{FO}	Fault Output Supply Voltage	Applied between : F _O -V _{N_C}	V _D +0.5	V
I _{FO}	Fault Output Current	Sink current at F _O terminal	20	mA

PM100CBS060

FLAT-BASE TYPE
INSULATED PACKAGE

TOTAL SYSTEM

Symbol	Parameter	Conditions	Ratings	Unit
VCC(PROT)	Supply Voltage Protected by OC & SC	V _D = 13.5 ~ 16.5V, Inverter Part, T _j = 125°C Start	400	V
VCC(surge)	Supply Voltage (Surge)	Applied between : P-N, Surge value	500	V
T _c	Module Case Operating Temperature	(Note-1)	-20 ~ +110	°C
T _{stg}	Storage Temperature		-40 ~ +125	°C
Viso	Isolation Voltage	60Hz, Sinusoidal Charged part to Base, AC 1 min.	2500	V _{rms}

(Note-1) T_c(under the chip) measurement point is below.

(Unit : mm)

Axis	UP		VP		WP		UN		VN		WN	
	IGBT	FWDi	IGBT	FWDi	IGBT	FWDi	IGBT	FWDi	IGBT	FWDi	IGBT	FWDi
X	83.3	83.3	41.8	41.8	16.8	16.8	70.8	70.8	54.3	54.3	29.3	29.3
Y	4.9	-4.8	4.9	-4.8	4.9	-4.8	-1.2	-10.8	-1.2	-10.8	-1.2	-10.8

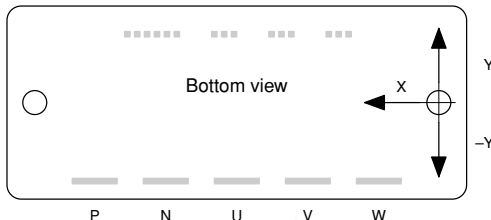

www.BDTIC.com/MITSUBISHI

THERMAL RESISTANCES

Symbol	Parameter	Test Conditions	Limits			Unit
			Min.	Typ.	Max.	
R _{th(j-c)Q}	Junction to case Thermal Resistances	T _c measured point is just under the chips Inverter IGBT part (per 1/6 module)	—	—	0.22*	°C/W
R _{th(j-c)F}		T _c measured point is just under the chips Inverter FWDi part (per 1/6 module)	—	—	0.36*	°C/W
R _{th(c-f)}	Contact Thermal Resistance	Case to fin, (per 1 module) Thermal grease applied	—	—	0.046	°C/W

*: If you use this value, R_{th(f-a)} should be measured just under the chips.

ELECTRICAL CHARACTERISTICS (T_j = 25°C, unless otherwise noted)

INVERTER PART

Symbol	Parameter	Test Conditions	Limits			Unit
			Min.	Typ.	Max.	
V _{CE(sat)}	Collector-Emitter Saturation Voltage	V _D = 15V, I _C = 100A V _{CIN} = 0V, Pulsed (Fig. 1)	—	1.7	2.3	V
		T _j = 25°C T _j = 125°C	—	1.7	2.3	
V _{EC}	FWDi Forward Voltage	-I _C = 100A, V _D = 15V, V _{CIN} = 15V (Fig. 2)	—	2.2	3.3	V
t _{on}	Switching Time	V _D = 15V, V _{CIN} = 15V↔0V V _{CC} = 300V, I _C = 100A T _j = 125°C Inductive Load (Fig. 3)	0.8	1.2	2.4	μs
t _{tr}			—	0.15	0.3	μs
t _{c(on)}			—	0.4	1.0	μs
t _{off}			—	2.4	3.3	μs
t _{c(off)}			—	0.5	1.0	μs
I _{CES}	Collector-Emitter Cutoff Current	V _{CE} = V _{CE(sat)} , V _D = 15V (Fig. 4)	—	—	1	mA
		T _j = 25°C T _j = 125°C	—	—	10	

PM100CBS060

FLAT-BASE TYPE
INSULATED PACKAGE

CONTROL PART

Symbol	Parameter	Test Conditions	Limits			Unit	
			Min.	Typ.	Max.		
I _D	Circuit Current	V _D = 15V, V _{CIN} = 15V	VN1-VNC	—	40	60	mA
			VXP1-VXPC	—	13	18	
V _{th(ON)}	Input ON Threshold Voltage	Applied between : UP-VUPC, VP-VVPC, WP-VWPC	1.2	1.5	1.8	V	
V _{th(OFF)}	Input OFF Threshold Voltage	UN • VN • WN-VNC	1.7	2.0	2.3	V	
OC	Over Current Trip Level	V _D = 15V (Fig. 5,6)	T _J = -20°C	—	—	470	A
			T _J = 25°C	220	290	390	
			T _J = 125°C	158	—	—	
SC	Short Circuit Trip Level	-20 ≤ T _J ≤ 125°C, V _D = 15V (Fig. 5,6)	—	360	—	A	
t _{off(OC)}	Over Current Delay Time	V _D = 15V (Fig. 5,6)	—	10	—	μs	
OT	Over Temperature protection	Detect T _J of IGBT chip	Trip level	135	145	155	°C
			Reset level	—	125	—	°C
UV	Supply Circuit Under-Voltage Protection	-20 ≤ T _J ≤ 125°C	Trip level	11.5	12.0	12.5	V
			Reset level	—	12.5	—	V
I _{FO(H)}	Fault Output Current	V _D = 15V, V _{FO} = 15V (Note-2)	—	—	0.01	mA	
I _{FO(L)}			—	10	15	mA	
t _{FO}	Minimum Fault Output Pulse Width	V _D = 15V (Note-2)	1.0	1.8	—	ms	

(Note-2) Fault output is given only when the internal OC, SC, OT & UV protection.
 Fault output of OC, SC, OT & UV protection operate by lower arm.
 Fault output of OC, SC protection given pulse.
 Fault output of OT, UV protection given pulse while over trip level.

www.BDTIC.com/MITSUBISHI

Symbol	Parameter	Test Conditions	Limits			Unit
			Min.	Typ.	Max.	
—	Mounting torque	Main terminal screw : M5	2.5	3.0	3.5	N • m
—	Mounting torque	Mounting part screw : M5	2.5	3.0	3.5	N • m
—	Weight	—	—	400	—	g

RECOMMENDED CONDITIONS FOR USE

Symbol	Parameter	Test Conditions	Recommended value	Unit
V _{CC}	Supply Voltage	Applied across P-N terminals	≤ 400	V
V _D	Control Supply Voltage	Applied between : VUP1-VUPC, VVP1-VVPC, VWP1-VWPC, VN1-VNC (Note-3)	15.0 ± 1.5	V
V _{CIN(ON)}	Input ON Voltage	Applied between : UP-VUPC, VP-VVPC, WP-VWPC, UN • VN • WN-VNC	≤ 0.8	V
V _{CIN(OFF)}	Input OFF Voltage		≥ 4.0	V
f _{PWM}	PWM Input Frequency	Using Application Circuit of Fig.8	≤ 20	kHz
t _{dead}	Arm Shoot-through Blocking Time	For IPM's each input signals (Fig. 7)	≥ 2.5	μs

(Note-3) With ripple satisfying the following conditions
 dv/dt swing ≤ ±5V/μs, Variation ≤ 2V peak to peak

PM100CBS060

FLAT-BASE TYPE
INSULATED PACKAGE

PRECAUTIONS FOR TESTING

1. Before applying any control supply voltage (V_D), the input terminals should be pulled up by resistors, etc. to their corresponding supply voltage and each input signal should be kept off state.
After this, the specified ON and OFF level setting for each input signal should be done.
2. When performing "OC" and "SC" tests, the turn-off surge voltage spike at the corresponding protection operation should not be allowed to rise above V_{CES} rating of the device.
(These test should not be done by using a curve tracer or its equivalent.)

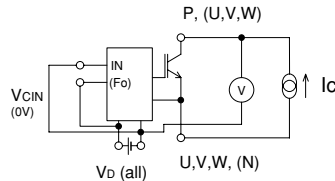

Fig. 1 $V_{CE(sat)}$ Test

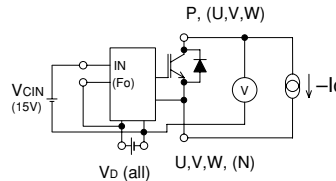
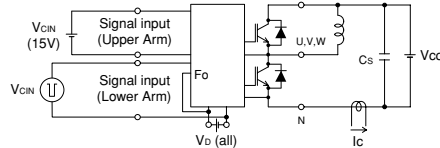

Fig. 2 V_{EC} Test

a) Lower Arm Switching



b) Upper Arm Switching

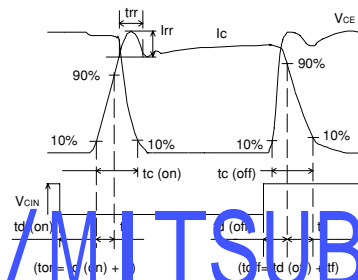
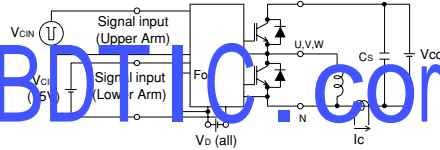

Fig. 3 Switching time Test circuit and waveform

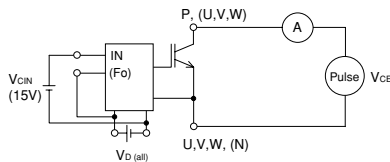

Fig. 4 I_{CES} Test

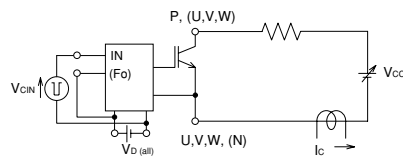

Fig. 5 OC and SC Test

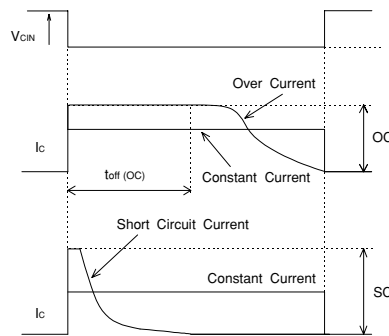

Fig. 6 OC and SC Test waveform

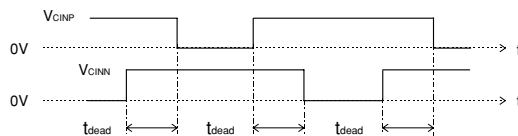

Fig. 7 Dead time measurement point example

PM100CBS060

FLAT-BASE TYPE
INSULATED PACKAGE

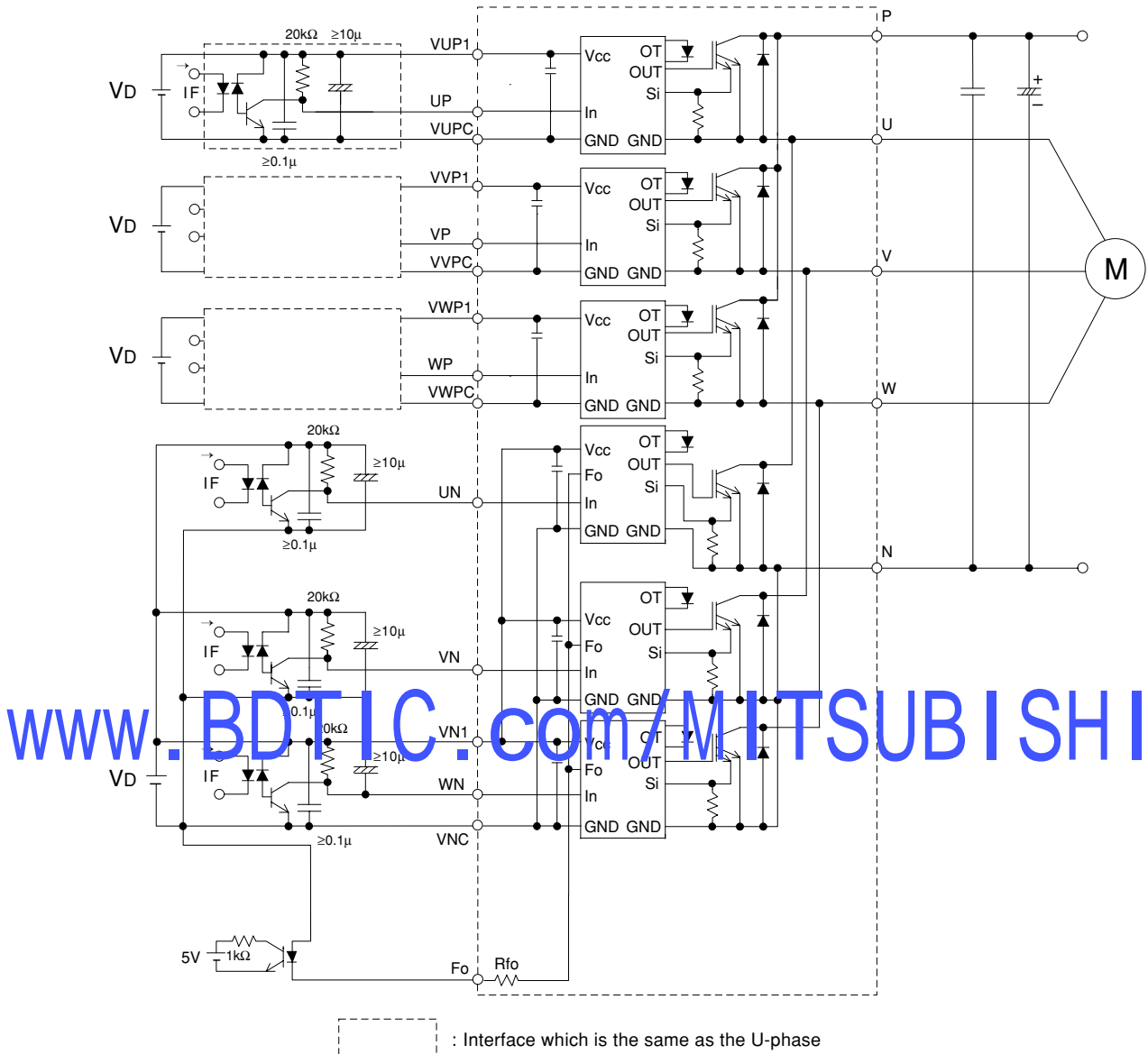

Fig. 8 Application Example Circuit

NOTES FOR STABLE AND SAFE OPERATION ;

- Design the PCB pattern to minimize wiring length between opto-coupler and IPM's input terminal, and also to minimize the stray capacity between the input and output wirings of opto-coupler.
- Connect low impedance capacitor between the V_{cc} and GND terminal of each fast switching opto-coupler.
- Fast switching opto-couplers : $t_{PLH}, t_{PHL} \leq 0.8\mu s$, Use High CMR type.
- Slow switching opto-coupler : CTR > 100%
- Use 4 isolated control power supplies (V_D). Also, care should be taken to minimize the instantaneous voltage charge of the power supply.
- Make inductance of DC bus line as small as possible, and minimize surge voltage using snubber capacitor between P and N terminal.
- Use line noise filter capacitor (ex. 4.7nF) between each input AC line and ground to reject common-mode noise from AC line and improve noise immunity of the system.