

PM100CVA120

FLAT-BASE TYPE
INSULATED PACKAGE

PM100CVA120



FEATURE

- 3φ 100A, 1200V Current-sense IGBT for 20kHz switching
- Monolithic gate drive & protection logic
- Detection, protection & status indication circuits for over-current, short-circuit, over-temperature & under-voltage (P-Fo available from upper leg devices)
- Acoustic noise-less 22kW class inverter application
- UL Recognized

Yellow Card No. E80276(N)

File No. E80271

APPLICATION

General purpose inverter, servo drives and other motor controls

PACKAGE OUTLINES

Dimensions in mm

www.BDTIC.com/MITSUBISHI

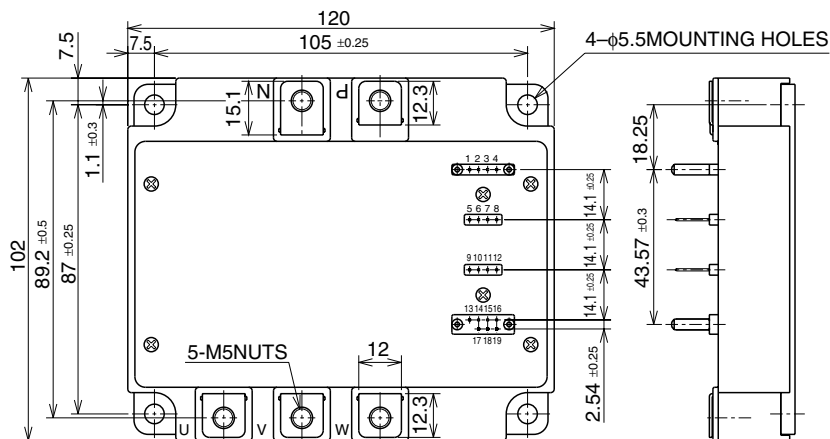

TERMINAL CODE

1. WFO	8. VVP1	15. VNC
2. VWPC	9. UFo	16. VN1
3. WP	10. VUPC	17. UN
4. VWP1	11. UP	18. VN
5. VFO	12. VUP1	19. WN
6. VVPC	13. NC	
7. VP	14. Fo	

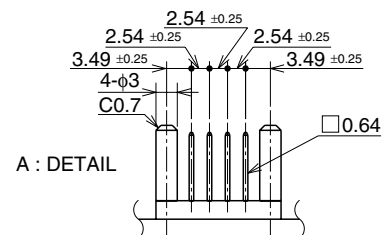
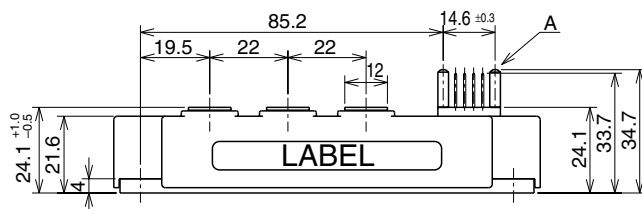

PM100CVA120

FLAT-BASE TYPE
INSULATED PACKAGE

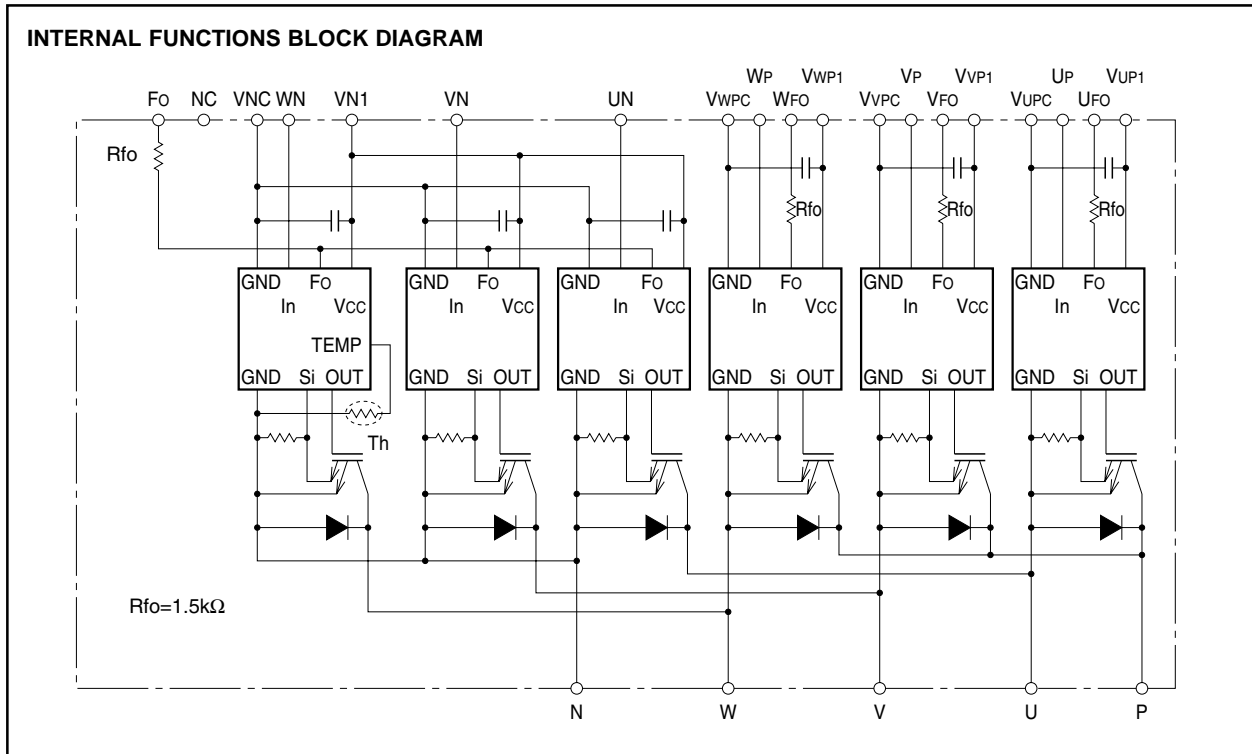

MAXIMUM RATING (Tj = 25°C unless otherwise noted)
INVERTER PART

Symbol	Parameter	Condition	Ratings	Unit
V _{CES}	Collector-Emitter Voltage	V _D = 15V, V _{CIN} = 15V	1200	V
±I _C	Collector Current	T _C = 25°C	100	A
±I _{CP}	Collector Current (Peak)	T _C = 25°C	200	A
P _C	Collector Dissipation	T _C = 25°C	541	W
T _j	Junction Temperature		-20 ~ +150	°C

CONTROL PART

Symbol	Parameter	Condition	Ratings	Unit
V _D	Supply Voltage	Applied between : V _{UP1} -V _{UPC} V _{VVP1} -V _{VVPC} , V _{WVP1} -V _{VWPC} , V _{VN1} -V _{VNC}	20	V
V _{CIN}	Input Voltage	Applied between : U _P -V _{UPC} , V _P -V _{VVPC} , W _P -V _{VWPC} U _N • V _N • W _N -V _{VNC}	20	V
V _{FO}	Fault Output Supply Voltage	Applied between : U _{FO} -V _{UPC} , V _{FO} -V _{VVPC} , W _{FO} -V _{VWPC} F _O -V _{VNC}	20	V
I _{FO}	Fault Output Current	Sink current at U _{FO} , V _{FO} , W _{FO} and F _O terminal	20	mA

PM100CVA120

FLAT-BASE TYPE
INSULATED PACKAGE

TOTAL SYSTEM

Symbol	Parameter	Condition	Ratings	Unit
V _{CC(Prot)}	Supply Voltage Protected by SC	V _D = 13.5 ~ 16.5V, Inverter Part, T _j = 125°C Start	800	V
V _{CC(surge)}	Supply Voltage (Surge)	Applied between : P-N, Surge value or without switching	1000	V
T _C	Module Case Operating Temperature	(Note-1)	-20 ~ +100	°C
T _{stg}	Storage Temperature		-40 ~ +125	°C
V _{iso}	Isolation Voltage	60Hz, Sinusoidal, Charged part to Base, AC 1 min.	2500	V _{rms}

(Note-1) T_C measurement point is below. (3mm depth at the center of the side of base plate)

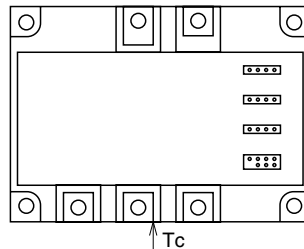

ELECTRICAL CHARACTERISTICS (T_j = 25°C, unless otherwise noted)

INVERTER PART

Symbol	Parameter	Test Condition	Limits			Unit
			Min.	Typ.	Max.	
V _{CE(sat)}	Collector-Emitter Saturation Voltage	V _D = 15V, I _C = 100A V _{CIN} = 0V	—	2.65	3.20	V
V _{CE}	Collector-Emitter Forward Voltage	-I _C = 100A, V _D = 15V, V _{CIN} = 5V	—	2.75	3.35	V
t _{on}	Switching Time	V _D = 15V, V _{CIN} = 0V↔15V V _{CC} = 600V, I _C = 100A T _j = 125°C Inductive Load (upper and lower arm)	0.4	0.9	2.3	μs
t _{rr}			—	0.2	0.3	
t _{c(on)}			—	0.4	1.0	
t _{off}			—	2.4	3.4	
t _{c(off)}			—	0.7	1.2	
IC _{ES}	Collector-Emitter Cutoff Current	V _{CE} = V _{CEs} , V _{CIN} = 15V	—	—	1	mA
		T _j = 125°C	—	—	10	

CONTROL PART

Symbol	Parameter	Test Condition	Limits			Unit
			Min.	Typ.	Max.	
I _D	Circuit Current	V _D = 15V, V _{CIN} = 15V	—	40	55	mA
		V _{N1-VNC} V _{P1-VPC}	—	13	18	
V _{th(ON)}	Input ON Threshold Voltage	Applied between : UP-VUPC, VP-VVPC, WP-VWPC	1.2	1.5	1.8	V
V _{th(OFF)}	Input OFF Threshold Voltage	U _N • V _N • W _N - V _{NC}	1.7	2.0	2.3	
SC	Short Circuit Trip Level	-20 ≤ T _j ≤ 125°C, V _D = 15V	145	—	—	A
t _{off(SC)}	Short Circuit Current Delay Time	V _D = 15V	—	10	—	μs
OT	Over Temperature Protection	Base-plate	Trip level	111	118	°C
OT _r		Temperature detection, V _D = 15V	Reset level	—	100	
UV	Supply Circuit Under-Voltage Protection	-20 ≤ T _j ≤ 125°C	Trip level	11.5	12.0	V
UV _r			Reset level	—	12.5	
I _{FO(H)}	Fault Output Current	V _D = 15V, V _{FO} = 15V	(Note-2)	—	0.01	mA
I _{FO(L)}			(Note-2)	—	10	
t _{FO}	Minimum Fault Output Pulse Width	V _D = 15V	(Note-2)	1.0	1.8	ms

(Note-2) Fault output is given only when the internal SC, OT & UV protection.
 Fault output of OT protection operate by lower arm
 Fault output of OT, UV protection given pulse while over level.

PM100CVA120

FLAT-BASE TYPE
INSULATED PACKAGE

THERMAL RESISTANCES

Symbol	Parameter	Test Condition	Limits			Unit
			Min.	Typ.	Max.	
R _{th(j-c)Q}	Junction to case Thermal Resistances	Inverter IGBT part (per 1/6 module)	—	—	0.231	°C/W
R _{th(j-c)F}		Inverter FWDi part (per 1/6 module)	—	—	0.35	
R _{th(c-f)}	Contact Thermal Resistance	Case to fin, Thermal grease applied (per 1 module)	—	—	0.022	

MECHANICAL RATINGS AND CHARACTERISTICS

Symbol	Parameter	Test Condition	Limits			Unit
			Min.	Typ.	Max.	
—	Mounting torque	Mounting part screw : M5	2.5	3.0	3.5	N • m
—	Mounting torque	Main terminal screw : M5	2.5	3.0	3.5	N • m
—	Weight		—	730	—	g

RECOMMENDED CONDITIONS FOR USE

Symbol	Parameter	Test Condition	Recommended value	Unit
V _{CC}	Supply Voltage	Applied across P-N terminals	≤ 800	V
V _D	Control Supply Voltage	Applied between : V _{UP1} -V _{UPC} , V _{VP1} -V _{VPC} V _{WP1} -V _{WPC} , V _{N1} -V _{NVC} (Note-3)	15 ± 1.5	V
V _{CIN(ON)}	Input ON Voltage	Applied between : U _P -V _{UPC} , V _P -V _{VPC} , W _P -V _{WPC} U _N • V _N • W _N -V _{NVC}	≤ 0.8	V
V _{CIN(OFF)}	Input OFF Voltage		≥ 4.0	
t _{dead}	Arm Shoot-through Blocking Time	For IPM's each input signals	≥ 3.0	μs
f _{PWM}	PWM Input Frequency	Using Application Circuit input signal of IPM, 3φ Sinosoidal PWM, VV1 inverter	≤ 20	kHz

Note 3: With ripple satisfying the following conditions: dv/dt swing ≤ ±5V/μs, Variation ≤ 2V peak to peak

PM100CVA120

FLAT-BASE TYPE
INSULATED PACKAGE

PERFORMANCE CURVES

OUTPUT CHARACTERISTICS (TYPICAL)

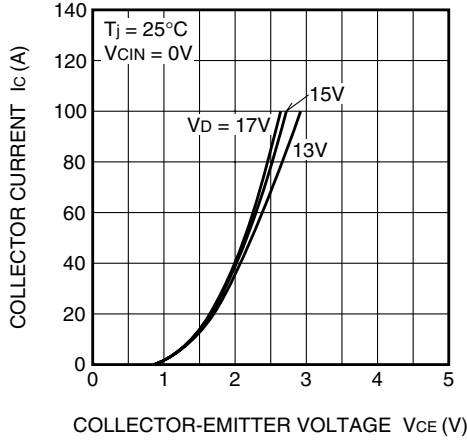

COLLECTOR-EMITTER SATURATION VOLTAGE CHARACTERISTICS (TYPICAL)

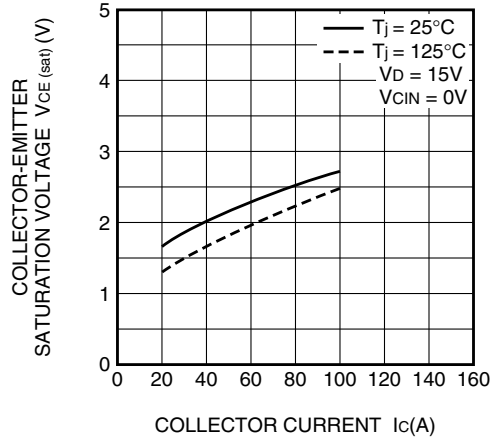

COLLECTOR-EMITTER SATURATION VOLTAGE CHARACTERISTICS (TYPICAL)

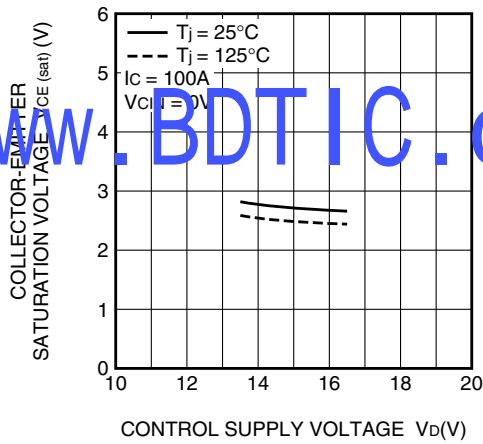

SWITCHING CHARACTERISTICS (TYPICAL)

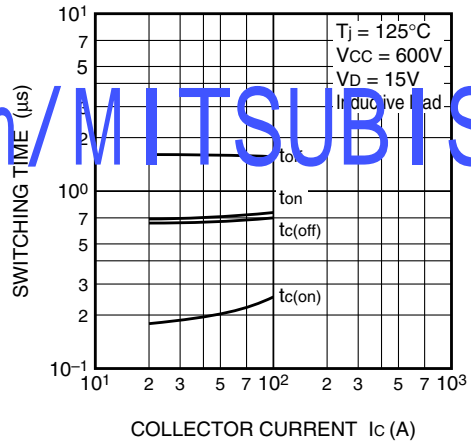

DIODE FORWARD CHARACTERISTICS (TYPICAL)

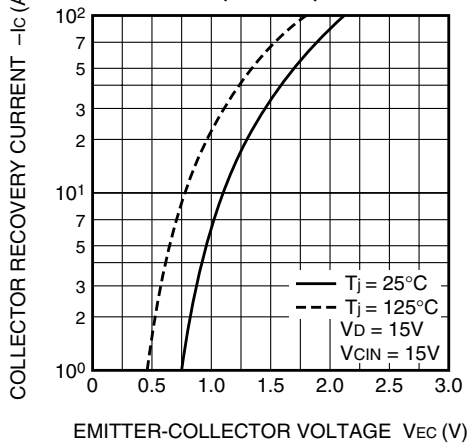

DIODE REVERSE RECOVERY CHARACTERISTICS (TYPICAL)

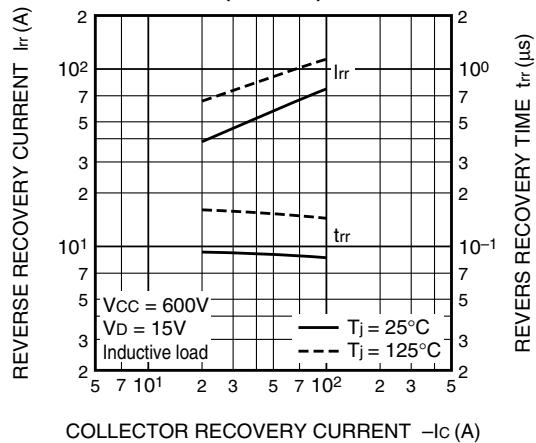

www.BDTIC.com/MITSUBISHI

PM100CVA120

FLAT-BASE TYPE
INSULATED PACKAGE

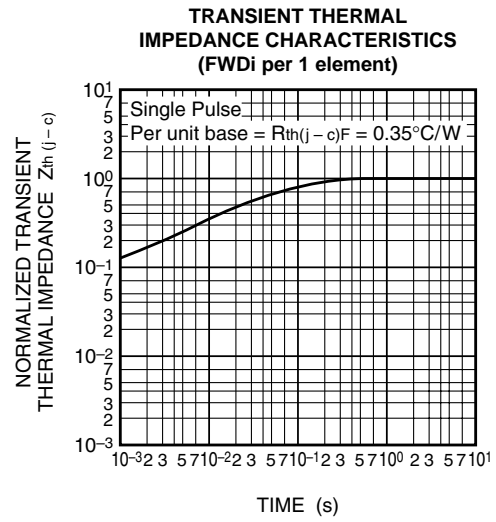
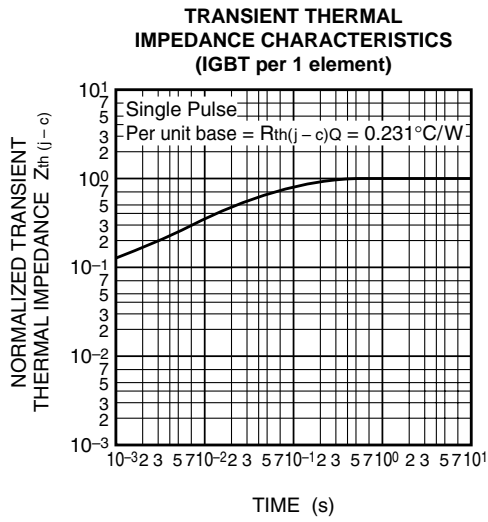

www.BDTIC.com/MITSUBISHI