

# PM150RL1A060

FLAT-BASE TYPE  
INSULATED PACKAGE

## PM150RL1A060



### FEATURE

Inverter + Brake + Drive & Protection IC

- a) Adopting new 5th generation Full-Gate CSTBT™ chip
- b) The over-temperature protection which detects the chip surface temperature of CSTBT™ is adopted.
- c) Error output signal is possible from all each protection upper and lower arm of IPM.
- d) Compatible L-series package.

- 3φ 150A, 600V Current-sense and temperature sense IGBT type inverter
- Monolithic gate drive & protection logic
- Detection, protection & status indication circuits for, short-circuit, over-temperature & under-voltage (P-FO available from upper arm devices)
- UL Recognized

## APPLICATION

General purpose inverter, servo drives and other motor controls

## PACKAGE OUTLINES

Dimensions in mm

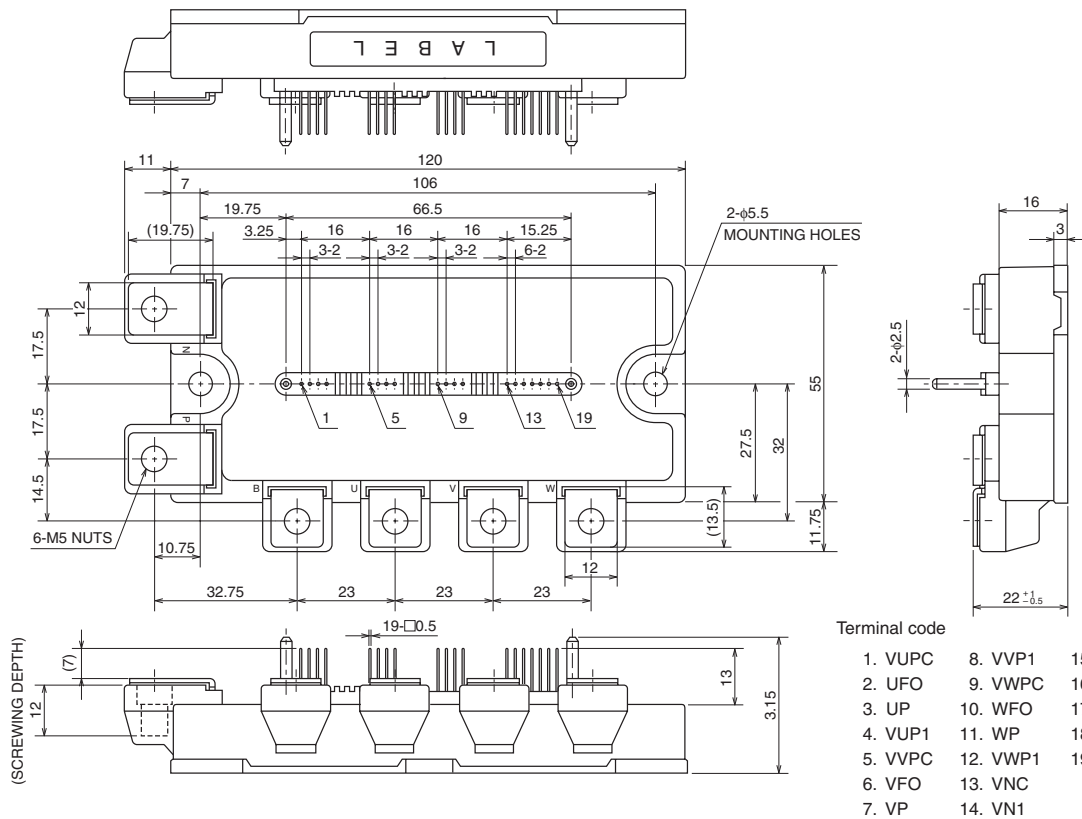

May 2009

# PM150RL1A060

FLAT-BASE TYPE  
INSULATED PACKAGE

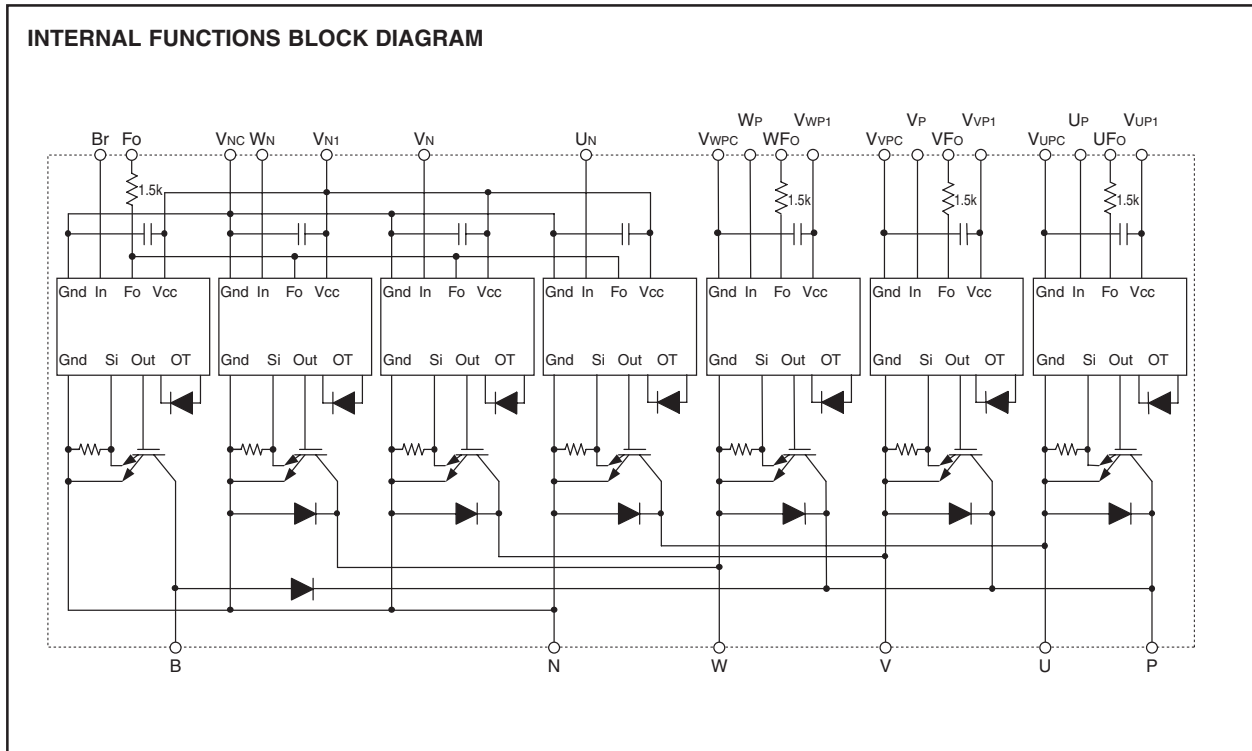

**MAXIMUM RATINGS** (Tj = 25°C, unless otherwise noted)

**INVERTER PART**

Symbol	Parameter	Condition	Ratings	Unit
V <sub>CES</sub>	Collector-Emitter Voltage	V <sub>D</sub> = 15V, V <sub>CIN</sub> = 15V	600	V
±I <sub>C</sub>	Collector Current	T <sub>C</sub> = 25°C (Note-1)	150	A
±I <sub>CP</sub>	Collector Current (Peak)	T <sub>C</sub> = 25°C	300	A
P <sub>C</sub>	Collector Dissipation	T <sub>C</sub> = 25°C (Note-1)	500	W
T <sub>j</sub>	Junction Temperature		-20 ~ +150	°C

\*: T<sub>c</sub> measurement point is just under the chip.

**BRAKE PART**

Symbol	Parameter	Condition	Ratings	Unit
V <sub>CES</sub>	Collector-Emitter Voltage	V <sub>D</sub> = 15V, V <sub>CIN</sub> = 15V	600	V
I <sub>C</sub>	Collector Current	T <sub>C</sub> = 25°C (Note-1)	75	A
I <sub>CP</sub>	Collector Current (Peak)	T <sub>C</sub> = 25°C	150	A
P <sub>C</sub>	Collector Dissipation	T <sub>C</sub> = 25°C (Note-1)	328	W
I <sub>F</sub>	FWDi Forward Current	T <sub>C</sub> = 25°C	75	A
V <sub>R(DC)</sub>	FWDi Rated DC Reverse Voltage	T <sub>C</sub> = 25°C	600	V
T <sub>j</sub>	Junction Temperature		-20 ~ +150	°C

**CONTROL PART**

Symbol	Parameter	Condition	Ratings	Unit
V <sub>D</sub>	Supply Voltage	Applied between : V <sub>UP1</sub> -V <sub>UPC</sub> , V <sub>V<sub>P1</sub></sub> -V <sub>V<sub>PC</sub></sub> V <sub>WP1</sub> -V <sub>W<sub>PC</sub></sub> , V <sub>N1</sub> -V <sub>N<sub>C</sub></sub>	20	V
V <sub>CIN</sub>	Input Voltage	Applied between : U <sub>P</sub> -U <sub>UPC</sub> , V <sub>P</sub> -V <sub>V<sub>PC</sub></sub> , W <sub>P</sub> -W <sub>W<sub>PC</sub></sub> U <sub>N</sub> • V <sub>N</sub> • W <sub>N</sub> • B <sub>r</sub> -V <sub>N<sub>C</sub></sub>	20	V
V <sub>F<sub>O</sub></sub>	Fault Output Supply Voltage	Applied between : U <sub>F<sub>O</sub></sub> -U <sub>V<sub>UPC</sub></sub> , V <sub>F<sub>O</sub></sub> -V <sub>V<sub>PC</sub></sub> , W <sub>F<sub>O</sub></sub> -W <sub>W<sub>PC</sub></sub> F <sub>O</sub> -V <sub>N<sub>C</sub></sub>	20	V
I <sub>F<sub>O</sub></sub>	Fault Output Current	Sink current at U <sub>F<sub>O</sub></sub> , V <sub>F<sub>O</sub></sub> , W <sub>F<sub>O</sub></sub> , F <sub>O</sub> terminals	20	mA

# PM150RL1A060

FLAT-BASE TYPE  
INSULATED PACKAGE

## TOTAL SYSTEM

Symbol	Parameter	Condition	Ratings	Unit
VCC(PROT)	Supply Voltage Protected by SC	V <sub>D</sub> = 13.5 ~ 16.5V Inverter Part, T <sub>j</sub> = +125°C Start	400	V
VCC(surge)	Supply Voltage (Surge)	Applied between : P-N, Surge value	500	V
T <sub>stg</sub>	Storage Temperature		-40 ~ +125	°C
V <sub>iso</sub>	Isolation Voltage	60Hz, Sinusoidal, Charged part to Base, AC 1 min.	2500	V <sub>rms</sub>

## THERMAL RESISTANCES

Symbol	Parameter	Condition	Limits			Unit
			Min.	Typ.	Max.	
R <sub>th(j-c)Q</sub>	Junction to case Thermal Resistances	Inverter IGBT part (per 1 element) (Note-1)	—	—	0.25	°C/W
R <sub>th(j-c)F</sub>		Inverter FWDi part (per 1 element) (Note-1)	—	—	0.41	
R <sub>th(j-c)Q</sub>		Brake IGBT part (Note-1)	—	—	0.38	
R <sub>th(j-c)F</sub>		Brake FWDi upper part (Note-1)	—	—	0.64	
R <sub>th(c-f)</sub>	Contact Thermal Resistance	Case to fin, (per 1 module) Thermal grease applied (Note-1)	—	—	0.038	

\* If you use this value, R<sub>th(f-a)</sub> should be measured just under the chips.

(Note-1) T<sub>c</sub> (under the chip) measurement point is below.

(unit : mm)

axis \ arm	UP		VP		WP		UN		VN		WN		BR	
	IGBT	FWDi	IGBT	FWDi	IGBT	FWDi	IGBT	FWDi	IGBT	FWDi	IGBT	FWDi	IGBT	Di
X	27.8	27.8	65.5	65.5	87.5	87.5	38.8	38.8	54.5	54.5	76.5	76.5	17.7	18.5
Y	-8.4	1.6	-8.4	-0.2	-8.4	-0.2	8.0	-0.4	8.0	-0.4	8.0	-0.4	-10.2	4.0

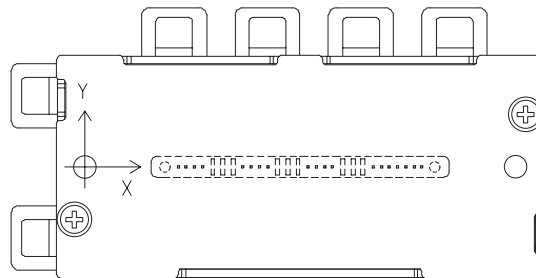

Bottom view

## ELECTRICAL CHARACTERISTICS (T<sub>j</sub> = 25°C, unless otherwise noted)

### INVERTER PART

Symbol	Parameter	Condition	Limits			Unit	
			Min.	Typ.	Max.		
V <sub>CE(sat)</sub>	Collector-Emitter Saturation Voltage	V <sub>D</sub> = 15V, I <sub>C</sub> = 150A V <sub>CE</sub> = 0V, Pulsed (Fig. 1)	T <sub>j</sub> = 25°C	—	1.75	2.35	V
			T <sub>j</sub> = 125°C	—	1.75	2.35	
V <sub>EC</sub>	FWDi Forward Voltage	-I <sub>C</sub> = 150A, V <sub>D</sub> = 15V, V <sub>CE</sub> = 15V (Fig. 2)	—	1.7	2.8	V	
t <sub>on</sub>	Switching Time	V <sub>D</sub> = 15V, V <sub>CE</sub> = 0V ↔ 15V V <sub>CE</sub> = 300V, I <sub>C</sub> = 150A T <sub>j</sub> = 125°C Inductive Load (Fig. 3,4)	0.3	0.8	2.0	μs	
t <sub>tr</sub>			—	0.4	0.8		
t <sub>c(on)</sub>			—	0.4	1.0		
t <sub>off</sub>			—	1.0	2.3		
t <sub>c(off)</sub>			—	0.3	1.0		
I <sub>CES</sub>	Collector-Emitter Cutoff Current	V <sub>CE</sub> = V <sub>CE(sat)</sub> , V <sub>D</sub> = 15V (Fig. 5)	T <sub>j</sub> = 25°C	—	—	1	mA
			T <sub>j</sub> = 125°C	—	—	10	

# PM150RL1A060

FLAT-BASE TYPE  
INSULATED PACKAGE

## BRAKE PART

Symbol	Parameter	Condition	Limits			Unit	
			Min.	Typ.	Max.		
V <sub>CE(sat)</sub>	Collector-Emitter Saturation Voltage	V <sub>D</sub> = 15V, I <sub>C</sub> = 75A V <sub>CIN</sub> = 0V, Pulsed (Fig. 1)	T <sub>J</sub> = 25°C	—	1.75	2.35	V
			T <sub>J</sub> = 125°C	—	1.75	2.35	
V <sub>EC</sub>	FWDi Forward Voltage	-I <sub>C</sub> = 75A, V <sub>CIN</sub> = 15V, V <sub>D</sub> = 15V (Fig. 2)	—	1.7	2.8	V	
I <sub>CES</sub>	Collector-Emitter Cutoff Current	V <sub>CE</sub> = V <sub>CES</sub> , V <sub>D</sub> = 15V (Fig. 5)	T <sub>J</sub> = 25°C	—	—	1	mA
			T <sub>J</sub> = 125°C	—	—	10	

## CONTROL PART

Symbol	Parameter	Condition	Limits			Unit	
			Min.	Typ.	Max.		
I <sub>D</sub>	Circuit Current	V <sub>D</sub> = 15V, V <sub>CIN</sub> = 15V	V <sub>N1-VNC</sub>	—	8	16	mA
			V*P1-V*PC	—	2	4	
V <sub>th(ON)</sub>	Input ON Threshold Voltage	Applied between : UP-VUPC, VP-VVPC, WP-VWPC UN • VN • WN • Br-VNC	1.2	1.5	1.8	V	
V <sub>th(OFF)</sub>	Input OFF Threshold Voltage		1.7	2.0	2.3		
SC	Short Circuit Trip Level	-20 ≤ T <sub>J</sub> ≤ 125°C, V <sub>D</sub> = 15V (Fig. 3,6)	Inverter part	300	—	—	A
			Brake part	150	—	—	
t <sub>off(SC)</sub>	Short Circuit Current Delay Time	V <sub>D</sub> = 15V (Fig. 3,6)	—	0.2	—	μs	
OT	Over Temperature Protection	Detect Temperature of IGBT chip	Trip level	135	—	—	°C
			Hysteresis	—	20	—	
UV	Supply Circuit Under-Voltage Protection	-20 ≤ T <sub>J</sub> ≤ 125°C	Trip level	11.5	12.0	12.5	V
			Reset level	—	12.5	—	
I <sub>FO(H)</sub>	Fault Output Current	V <sub>D</sub> = 15V, V <sub>CIN</sub> = 15V (Note-2)	—	—	0.01	mA	
I <sub>FO(L)</sub>			—	10	15		
t <sub>FO</sub>	Minimum Fault Output Pulse Width	V <sub>D</sub> = 15V (Note-2)	1.0	1.8	—	ms	

(Note-2) Fault output is given only when the internal SC, OT & UV protections schemes of either upper or lower arm device operate to protect it.

## MECHANICAL RATINGS AND CHARACTERISTICS

Symbol	Parameter	Condition	Limits			Unit
			Min.	Typ.	Max.	
—	Mounting torque	Mounting part screw : M5	2.5	3.0	3.5	N • m
—	Mounting torque	Main terminal part screw : M5	2.5	3.0	3.5	N • m
—	Weight	—	—	380	—	g

## RECOMMENDED CONDITIONS FOR USE

Symbol	Parameter	Condition	Recommended value	Unit
V <sub>CC</sub>	Supply Voltage	Applied across P-N terminals	≤ 400	V
V <sub>D</sub>	Control Supply Voltage	Applied between : VUP1-VUPC, VVP1-VVPC VWP1-VWPC, VN1-VNC (Note-3)	15.0 ± 1.5	V
V <sub>CIN(ON)</sub>	Input ON Voltage	Applied between : UP-VUPC, VP-VVPC, WP-VWPC UN • VN • WN • Br-VNC	≤ 0.8	V
V <sub>CIN(OFF)</sub>	Input OFF Voltage		≥ 9.0	
f <sub>PWM</sub>	PWM Input Frequency	Using Application Circuit of Fig. 8	≤ 20	kHz
t <sub>dead</sub>	Arm Shoot-through Blocking Time	For IPM's each input signals (Fig. 7)	≥ 2.0	μs

(Note-3) With ripple satisfying the following conditions: dv/dt swing ≤ ±5V/μs, Variation ≤ 2V peak to peak

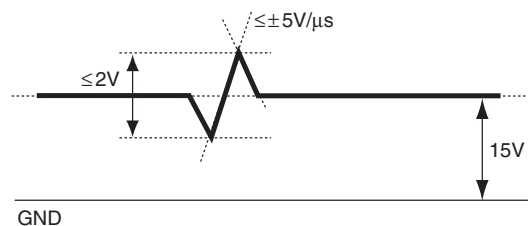

# PM150RL1A060

FLAT-BASE TYPE  
INSULATED PACKAGE

## PRECAUTIONS FOR TESTING

1. Before applying any control supply voltage ( $V_D$ ), the input terminals should be pulled up by resistors, etc. to their corresponding supply voltage and each input signal should be kept off state.  
After this, the specified ON and OFF level setting for each input signal should be done.
2. When performing "SC" tests, the turn-off surge voltage spike at the corresponding protection operation should not be allowed to rise above  $V_{CES}$  rating of the device.  
(These test should not be done by using a curve tracer or its equivalent.)

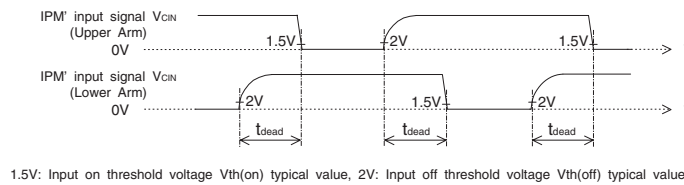
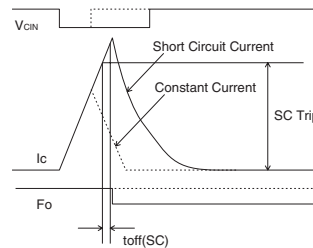
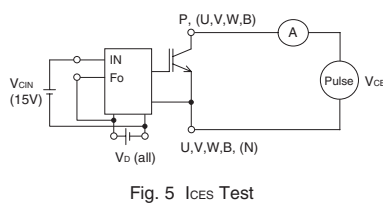
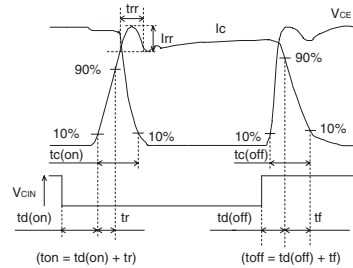
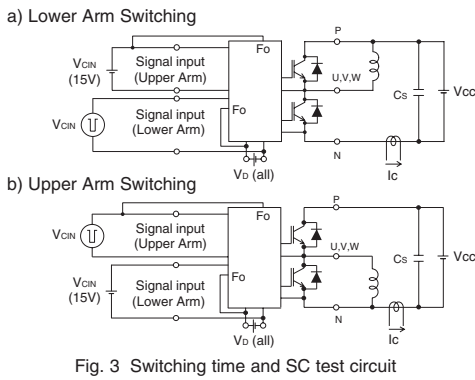
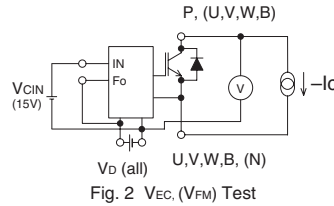
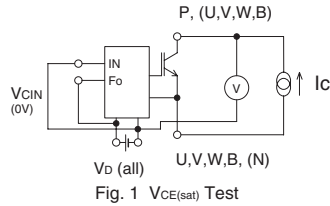

# PM150RL1A060

FLAT-BASE TYPE  
INSULATED PACKAGE

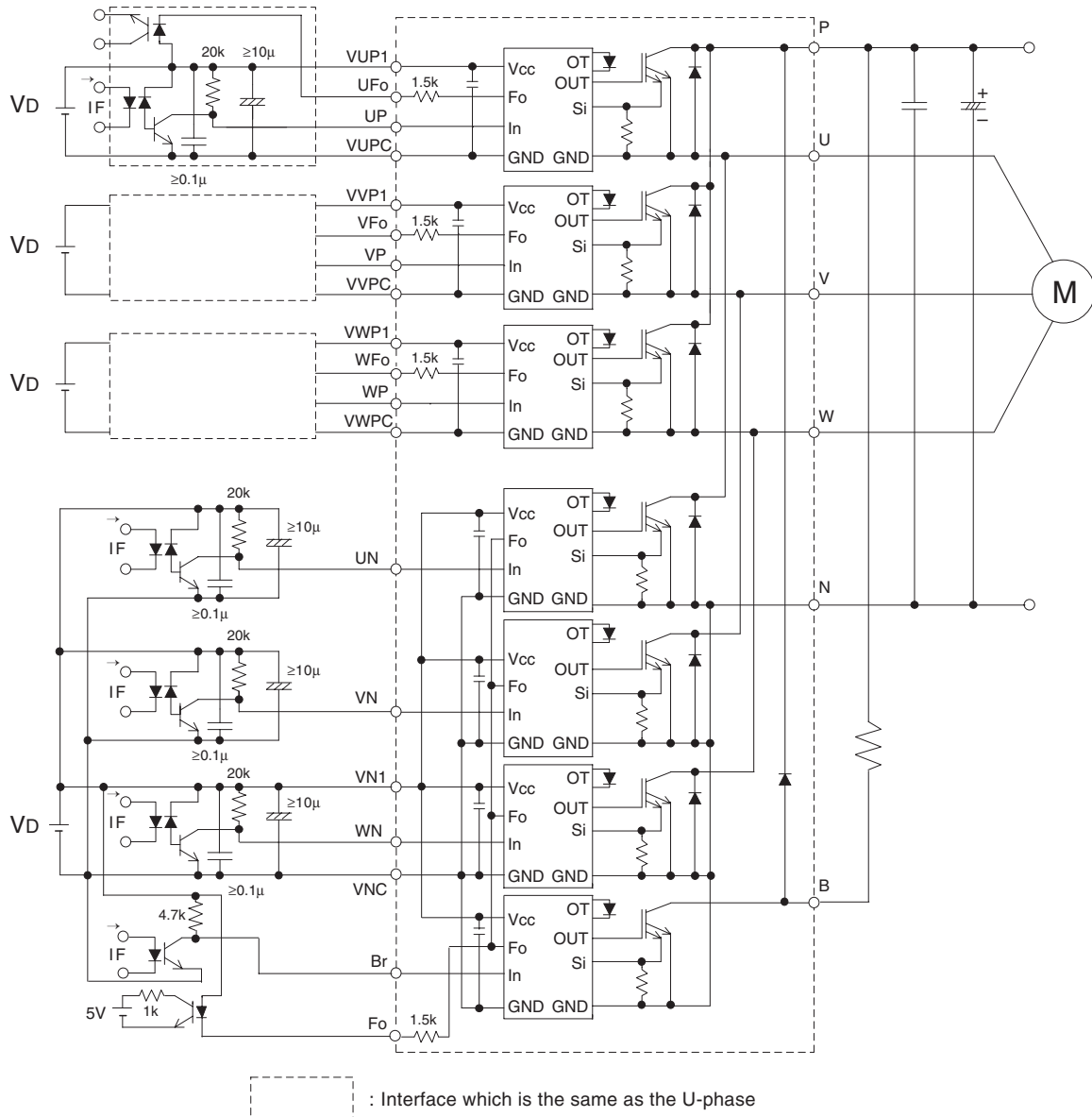

Fig. 8 Application Example Circuit

**NOTES FOR STABLE AND SAFE OPERATION ;**

- Design the PCB pattern to minimize wiring length between opto-coupler and IPM's input terminal, and also to minimize the stray capacity between the input and output wirings of opto-coupler.
- Connect low impedance capacitor between the Vcc and GND terminal of each fast switching opto-coupler.
- Fast switching opto-couplers:  $t_{PLH}, t_{PHL} \leq 0.8\mu s$ , Use High CMR type.
- Slow switching opto-coupler: CTR > 100%
- Use 4 isolated control power supplies (VD). Also, care should be taken to minimize the instantaneous voltage charge of the power supply.
- Make inductance of DC bus line as small as possible, and minimize surge voltage using snubber capacitor between P and N terminal.
- Use line noise filter capacitor (ex. 4.7nF) between each input AC line and ground to reject common-mode noise from AC line and improve noise immunity of the system.

# PM150RL1A060

FLAT-BASE TYPE  
INSULATED PACKAGE

**PERFORMANCE CURVES**  
(Inverter Part)

**OUTPUT CHARACTERISTICS (TYPICAL)**

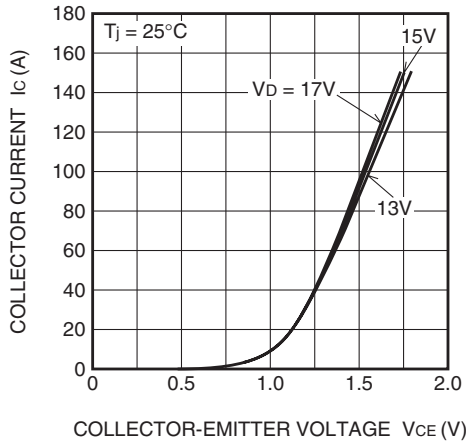

**COLLECTOR-EMITTER SATURATION VOLTAGE (VS.  $I_c$ ) CHARACTERISTICS (TYPICAL)**

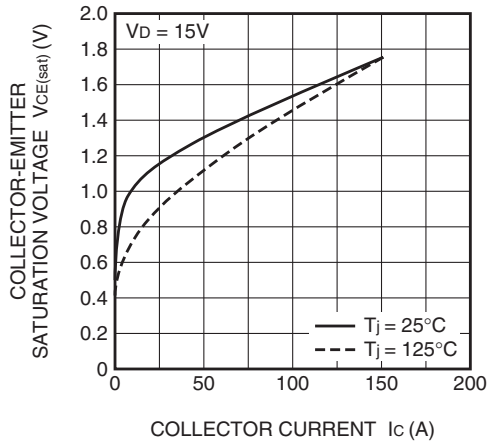

**COLLECTOR-EMITTER SATURATION VOLTAGE (VS.  $V_D$ ) CHARACTERISTICS (TYPICAL)**

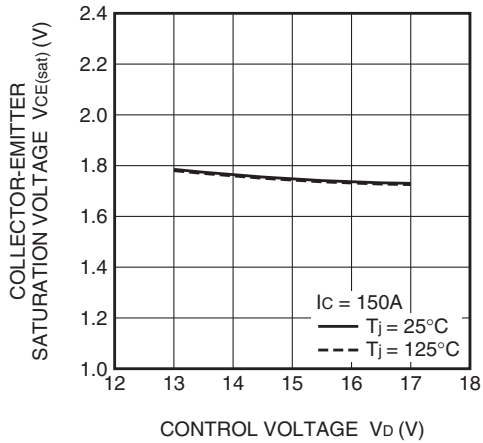

**DIODE FORWARD CHARACTERISTICS (TYPICAL)**

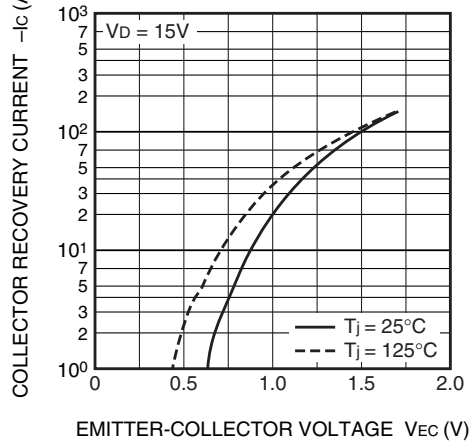

**SWITCHING TIME ( $t_{on}$ ,  $t_{off}$ ) CHARACTERISTICS (TYPICAL)**

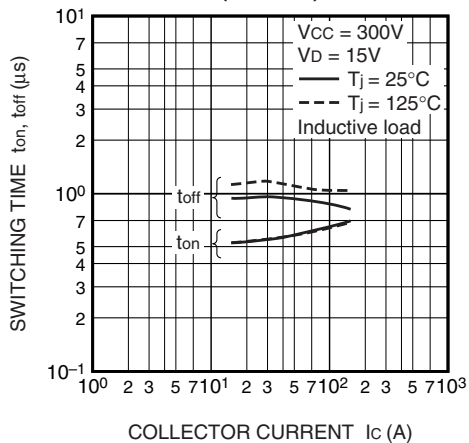

**SWITCHING TIME ( $t_{c(on)}$ ,  $t_{c(off)}$ ) CHARACTERISTICS (TYPICAL)**

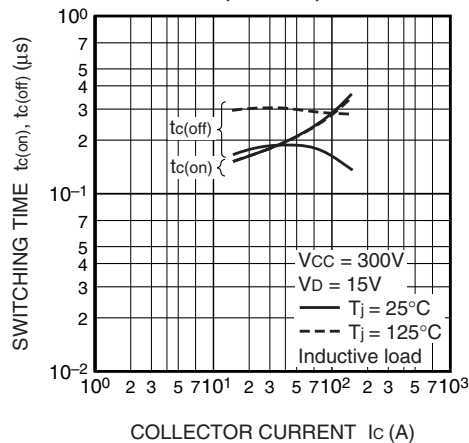

# PM150RL1A060

FLAT-BASE TYPE  
INSULATED PACKAGE

**SWITCHING LOSS CHARACTERISTICS (TYPICAL)**

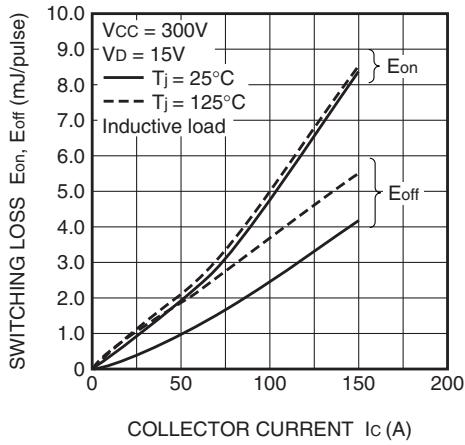

**DIODE REVERSE RECOVERY CHARACTERISTICS (TYPICAL)**

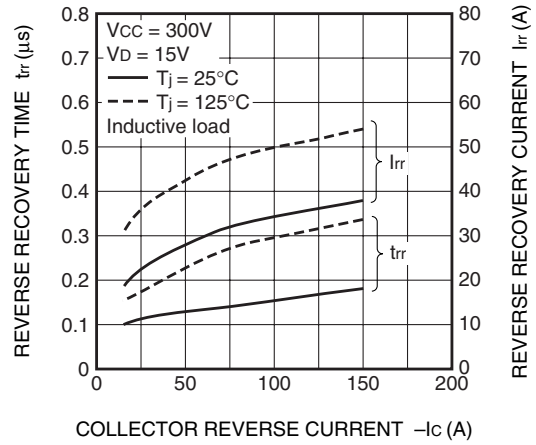

**SWITCHING RECOVERY LOSS CHARACTERISTICS (TYPICAL)**

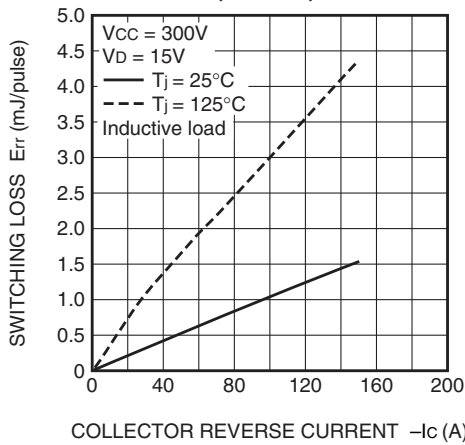

**$I_D$  VS.  $f_c$  CHARACTERISTICS (TYPICAL)**

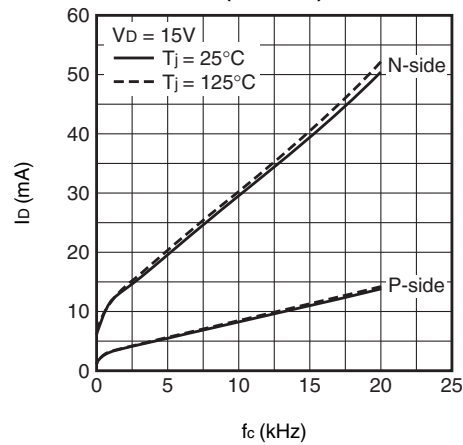

**UV TRIP LEVEL VS.  $T_j$  CHARACTERISTICS (TYPICAL)**

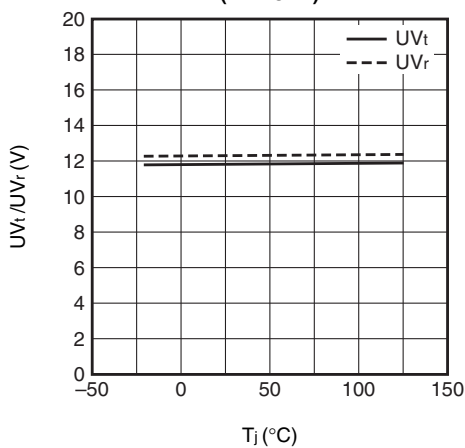

**SC TRIP LEVEL VS.  $T_j$  CHARACTERISTICS (TYPICAL)**

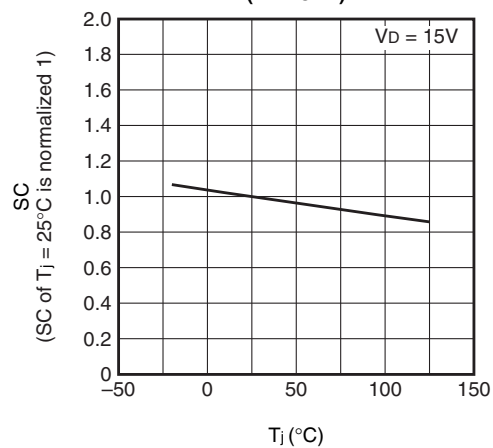



# PM150RL1A060

FLAT-BASE TYPE  
INSULATED PACKAGE

(Brake Part)

