

RM1800HE-34S

HIGH POWER SWITCHING USE
INSULATED TYPE

High Voltage Diode Module

RM1800HE-34S



- IF 1800A
- VRRM 1700V
- Insulated Type
- 1-element in a Pack
- AISiC Baseplate

APPLICATION

Traction drives, High Reliability Converters / Inverters, DC choppers

OUTLINE DRAWING & CIRCUIT DIAGRAM

Dimensions in mm

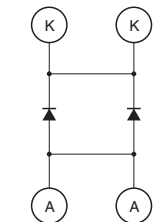
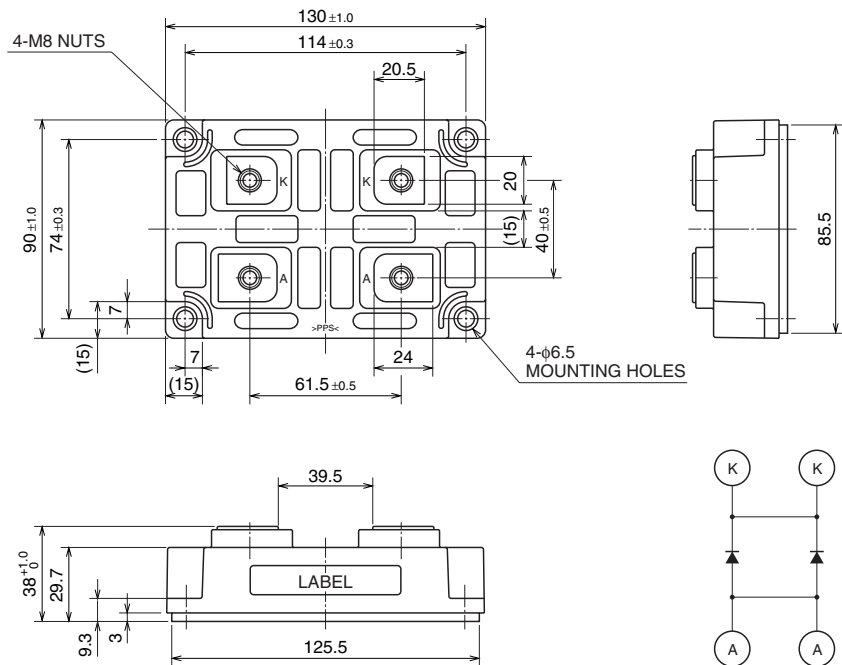

CIRCUIT DIAGRAM

High Voltage Diode Module

May 2009

RM1800HE-34S

**HIGH POWER SWITCHING USE
INSULATED TYPE**

High Voltage Diode Module

MAXIMUM RATINGS

Symbol	Item	Conditions	Ratings	Unit
VRRM	Repetitive peak reverse voltage	T _j = 25 °C	1700	V
VRSM	Non-repetitive peak reverse voltage	T _j = 25 °C	1700	V
VR(DC)	Reverse DC voltage	T _j = 25 °C	1150	V
IF	DC forward current (Note 1)	T _c = 25 °C	1800	A
IFSM	Surge forward current	T _j = 25 °C start, t _w = 8.3 ms Half sign wave	9600	A
i ² t	Current-squared, time integration	T _j = 25 °C start, t _w = 8.3 ms Half sign wave	384	kA ² s
V _{iso}	Isolation voltage	Charged part to the baseplate RMS sinusoidal, 60Hz 1min.	6000	V
T _j	Junction temperature	—	-40 ~ +150	°C
T _{op}	Operating temperature	—	-40 ~ +125	°C
T _{stg}	Storage temperature	—	-40 ~ +125	°C

Note 1. Continuous DC current should be limited to equal to or less than 1200A due to current capacity of internal electrodes.

ELECTRICAL CHARACTERISTICS

Symbol	Item	Conditions	Limits			Unit	
			Min	Typ	Max		
IRRM	Repetitive reverse current	V _{RM} = VRRM	T _j = 25 °C	—	—	5	mA
			T _j = 125 °C	—	—	30	
VFM	Forward voltage (Note 2)	IF = 1800 A	T _j = 25 °C	—	2.90	—	V
			T _j = 125 °C	—	2.40	—	
t _{rr}	Reverse recovery time	V _R = 750 V, I _F = 1800 A di/dt = -4000 A/μs L _s =100nH, T _j = 125 °C	—	0.80	1.8	μs	
I _{rr}	Reverse recovery current		—	850	—	A	
Q _{rr}	Reverse recovery charge		—	600	—	μC	
E _{rec}	Reverse recovery energy (Note 3)		—	0.40	—	J/P	

Note 2. It doesn't include the voltage drop by internal lead resistance.

3. E_{rec} is the integral of 0.1V_R x 0.1I_{rr} x dt.

RM1800HE-34S

HIGH POWER SWITCHING USE
INSULATED TYPE

High Voltage Diode Module

THERMAL CHARACTERISTICS

Symbol	Item	Conditions	Limits			Unit
			Min	Typ	Max	
R _{th(j-c)}	Thermal resistance	Junction to case	—	—	22.0	K/kW
R _{th(c-f)}	Contact thermal resistance	Case to Fin, λ _{grease} = 1W/m·K D(c-f)=100μm	—	17.0	—	K/kW

MECHANICAL CHARACTERISTICS

Symbol	Item	Conditions	Limits			Unit
			Min	Typ	Max	
M _t	Mounting torque	M8: Main terminals screw	6.67	—	13.0	N·m
M _s		M6: Mounting screw	2.84	—	6.0	N·m
m	Mass	—	—	0.66	—	kg

PERFORMANCE CURVES

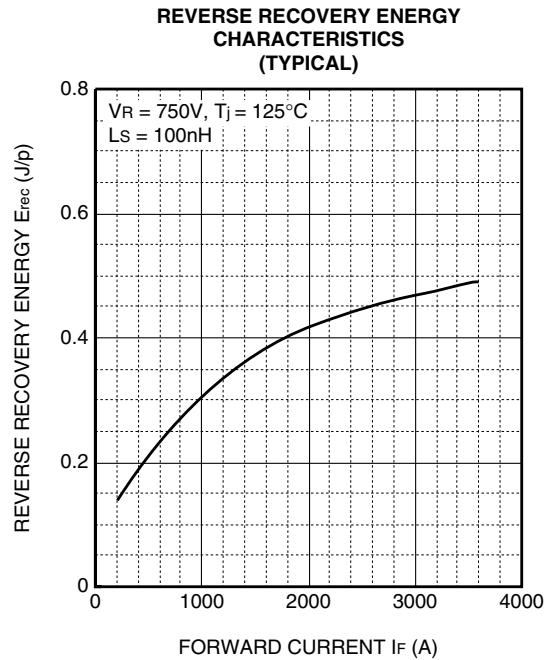
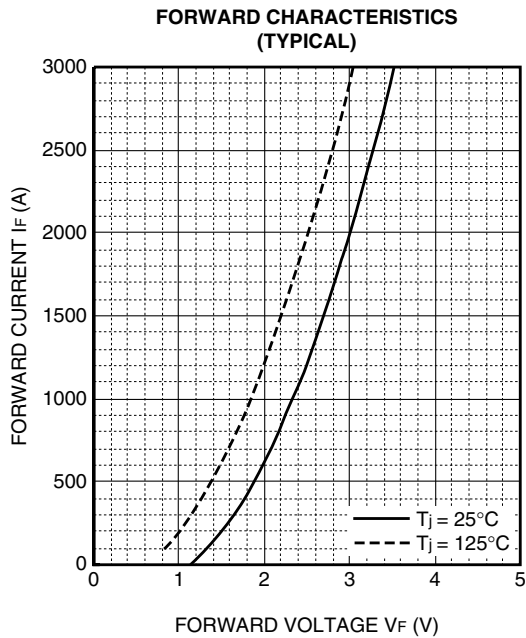

RM1800HE-34S

**HIGH POWER SWITCHING USE
INSULATED TYPE**

High Voltage Diode Module

REVERSE RECOVERY CHARACTERISTICS (TYPICAL)

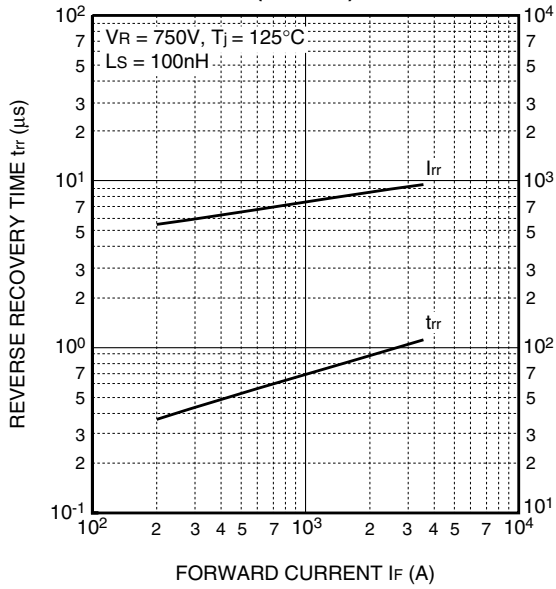

REVERSE RECOVERY SAFE OPERATING AREA (RRSOA)

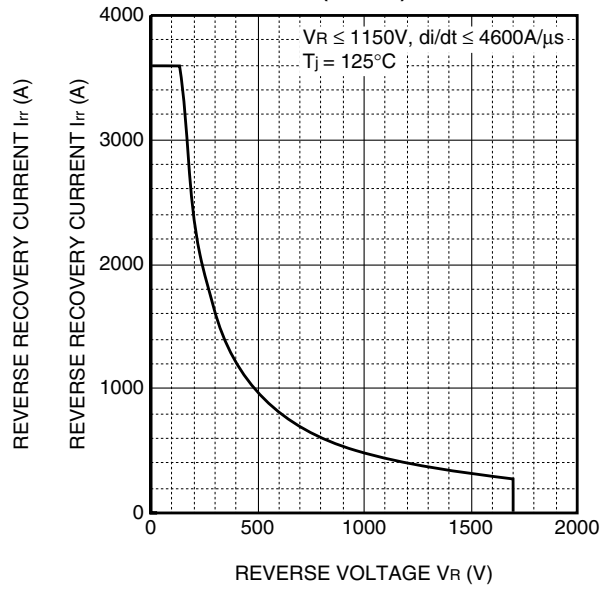

TRANSIENT THERMAL IMPEDANCE CHARACTERISTICS

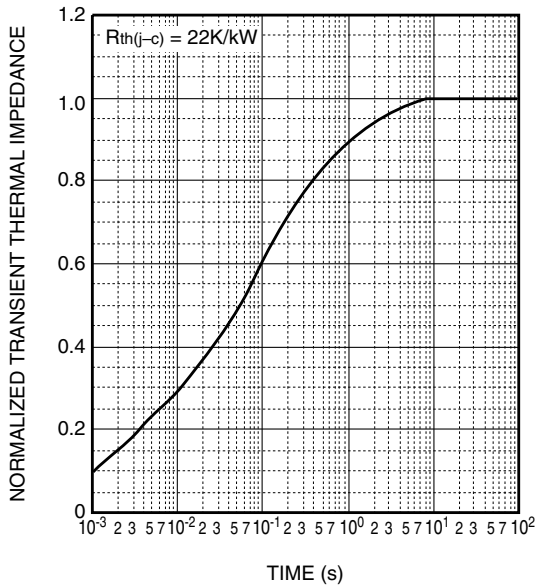

High Voltage Diode Module

May 2009