

# RM600HE-90S

HIGH POWER SWITCHING USE  
INSULATED TYPE

High Voltage Diode Module

## RM600HE-90S



- IF ..... 600A
- VRRM ..... 4500V
- Insulated Type
- 1-element in a Pack
- AISiC Baseplate

## APPLICATION

Traction drives, High Reliability Converters / Inverters, DC choppers

## OUTLINE DRAWING & CIRCUIT DIAGRAM

Dimensions in mm

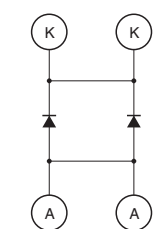
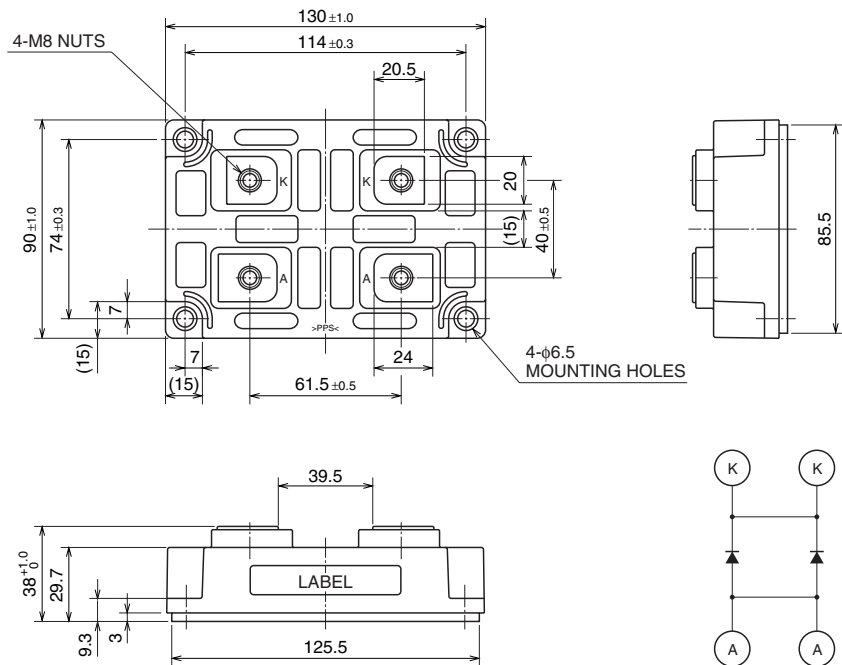

CIRCUIT DIAGRAM

High Voltage Diode Module

**RM600HE-90S**

**HIGH POWER SWITCHING USE  
INSULATED TYPE**

High Voltage Diode Module

**MAXIMUM RATINGS**

Symbol	Item	Conditions	Ratings	Unit
VRRM	Repetitive peak reverse voltage	T <sub>j</sub> = 25 °C	4500	V
VRSM	Non-repetitive peak reverse voltage	T <sub>j</sub> = 25 °C	4500	V
VR(DC)	Reverse DC voltage	T <sub>j</sub> = 25 °C	3000	V
IF	DC forward current	T <sub>c</sub> = 25 °C	600	A
IFSM	Surge forward current	T <sub>j</sub> = 25 °C start, t <sub>w</sub> = 8.3 ms Half sign wave	4800	A
i <sup>2</sup> t	Current-squared, time integration	T <sub>j</sub> = 25 °C start, t <sub>w</sub> = 8.3 ms Half sign wave	95.6	kA <sup>2</sup> s
V <sub>iso</sub>	Isolation voltage	Charged part to the baseplate RMS sinusoidal, 60Hz 1min.	6000	V
T <sub>j</sub>	Junction temperature	—	-40 ~ +150	°C
T <sub>op</sub>	Operating temperature	—	-40 ~ +125	°C
T <sub>stg</sub>	Storage temperature	—	-40 ~ +125	°C

**ELECTRICAL CHARACTERISTICS**

Symbol	Item	Conditions	Limits			Unit
			Min	Typ	Max	
IRRM	Repetitive reverse current	V <sub>RM</sub> = VRRM	T <sub>j</sub> = 25 °C	—	5	mA
			T <sub>j</sub> = 125 °C	—	30	
VFM	Forward voltage (Note 1)	I <sub>F</sub> = 600 A	T <sub>j</sub> = 25 °C	—	4.80	V
			T <sub>j</sub> = 125 °C	—	4.20	
t <sub>rr</sub>	Reverse recovery time	V <sub>R</sub> = 2250 V, I <sub>F</sub> = 600 A di/dt = -1400 A/μs L <sub>s</sub> = 100nH, T <sub>j</sub> = 125 °C	—	0.9	1.8	μs
I <sub>rr</sub>	Reverse recovery current		—	615	—	A
Q <sub>rr</sub>	Reverse recovery charge		—	600	—	μC
E <sub>rec</sub>	Reverse recovery energy (Note 2)		—	0.62	—	J/P

Note 1. It doesn't include the voltage drop by internal lead resistance.  
2. E<sub>rec</sub> is the integral of 0.1V<sub>R</sub> x 0.1I<sub>rr</sub> x dt.

**RM600HE-90S**

**HIGH POWER SWITCHING USE  
INSULATED TYPE**

High Voltage Diode Module

**THERMAL CHARACTERISTICS**

Symbol	Item	Conditions	Limits			Unit
			Min	Typ	Max	
$R_{th(j-c)}$	Thermal resistance	Junction to case	—	—	39.0	K/kW
$R_{th(c-f)}$	Contact thermal resistance	Case to Fin, $\lambda_{grease} = 1W/m-K$ $D(c-f)=100\mu m$	—	15.0	—	K/kW

**MECHANICAL CHARACTERISTICS**

Symbol	Item	Conditions	Limits			Unit
			Min	Typ	Max	
$M_t$	Mounting torque	M8: Main terminals screw	6.67	—	13.0	N-m
$M_s$		M6: Mounting screw	2.84	—	6.0	N-m
m	Mass	—	—	0.66	—	kg

**PERFORMANCE CURVES**

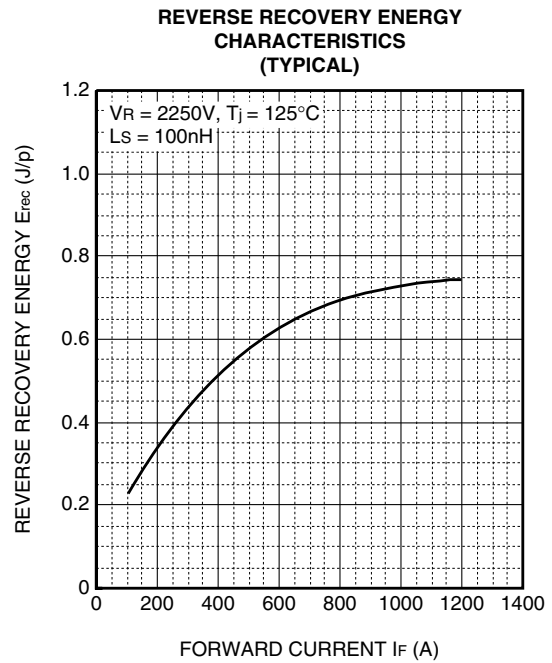
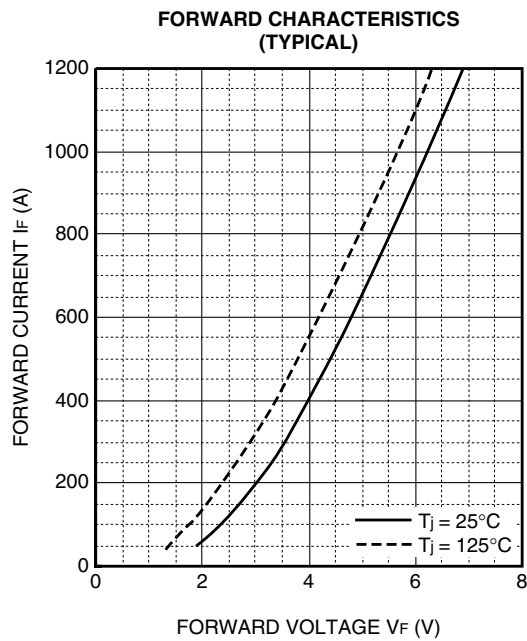

**RM600HE-90S**

**HIGH POWER SWITCHING USE  
INSULATED TYPE**

High Voltage Diode Module

**REVERSE RECOVERY CHARACTERISTICS (TYPICAL)**

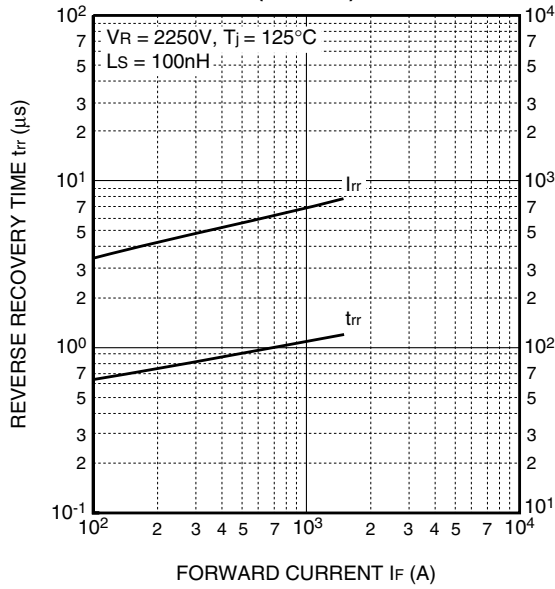

**REVERSE RECOVERY SAFE OPERATING AREA (RRSOA)**

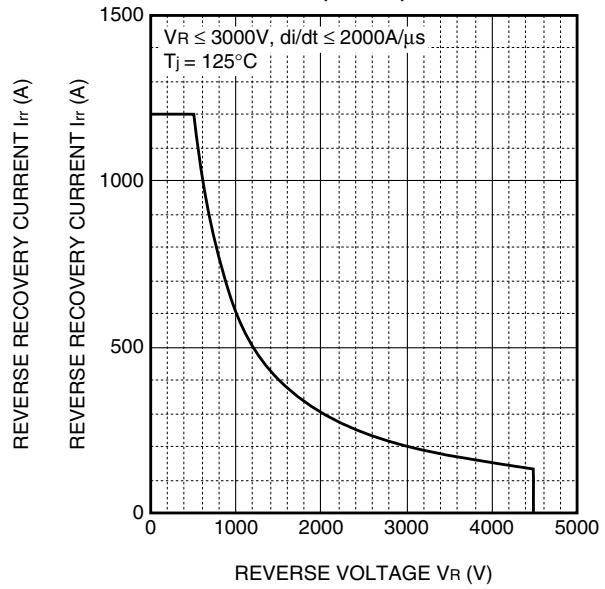

**TRANSIENT THERMAL IMPEDANCE CHARACTERISTICS**

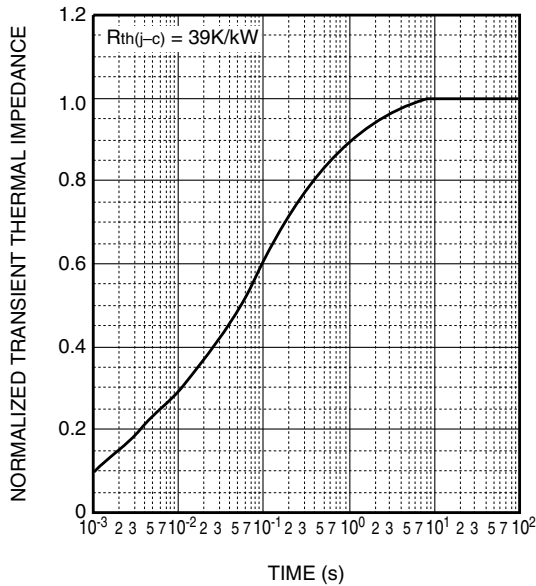

High Voltage Diode Module

May 2009