

MBRAF3200T3G

Surface Mount Schottky Power Rectifier

This device employs the Schottky Barrier principle in a large area metal-to-silicon power diode. State-of-the-art geometry features epitaxial construction with oxide passivation and metal overlay contact. Ideally suited for low voltage, high frequency rectification, or as free wheeling and polarity protection diodes in surface mount applications where compact size and weight are critical to the system.

Features

- Small Compact Surface Mountable Package with J-Bend Leads
- Rectangular Package for Automated Handling
- Highly Stable Oxide Passivated Junction
- Very High Blocking Voltage – 200 V
- 150°C Operating Junction Temperature
- Guard-Ring for Stress Protection
- This is a Pb-Free Device

Mechanical Characteristics

- Case: Epoxy, Molded, Epoxy Meets UL 94, V-0
- Weight: 95 mg (approximately)
- Finish: All External Surfaces Corrosion Resistant and Terminal Leads are Readily Solderable
- Lead and Mounting Surface Temperature for Soldering Purposes: 260°C Max. for 10 Seconds
- Cathode Polarity Band
- Device Meets MSL 1 Requirements
- ESD Ratings: Machine Model = A
Human Body Model = 1B

MAXIMUM RATINGS

| Rating | Symbol | Value | Unit |
|--|---------------------------------|-------------|------|
| Peak Repetitive Reverse Voltage Working Peak Reverse Voltage DC Blocking Voltage | V_{RRM} V_{RWM} V_R | 200 | V |
| Average Rectified Forward Current ($T_L = 100^\circ\text{C}$) | $I_{F(AV)}$ | 3.0 | A |
| Non-Repetitive Peak Surge Current (Surge Applied at Rated Load Conditions Halfwave, Single Phase, 60 Hz) | I_{FSM} | 100 | A |
| Operating Junction Temperature | T_J | -65 to +150 | °C |

Stresses exceeding Maximum Ratings may damage the device. Maximum Ratings are stress ratings only. Functional operation above the Recommended Operating Conditions is not implied. Extended exposure to stresses above the Recommended Operating Conditions may affect device reliability.



ON Semiconductor®

<http://onsemi.com>

**SCHOTTKY BARRIER
RECTIFIER
3.0 AMPERE
200 VOLTS**

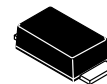

**SMA-FL
CASE 403AA
PLASTIC
STYLE 6**

MARKING DIAGRAM



RAC = Specific Device Code
A = Assembly Location
Y = Year
WW = Work Week
▪ = Pb-Free Package
(Note: Microdot may be in either location)

ORDERING INFORMATION

| Device | Package | Shipping† |
|--------------|---------------------|--------------------|
| MBRAF3200T3G | SMA-FL (Pb-Free) | 5000 / Tape & Reel |

† For information on tape and reel specifications, including part orientation and tape sizes, please refer to our Tape and Reel Packaging Specification Brochure, BRD8011/D.

MBRAF3200T3G

THERMAL CHARACTERISTICS

| Characteristic | Symbol | Value | Unit |
|--|-----------------|-------|---------------|
| Thermal Resistance, Junction-to-Lead (Note 1) | $R_{\theta JL}$ | 25 | $^{\circ}C/W$ |
| Thermal Resistance, Junction-to-Ambient (Note 1) | $R_{\theta JA}$ | 90 | $^{\circ}C/W$ |

1. 1 inch square pad size (1 × 0.5 inch) for each lead on FR4 board.

ELECTRICAL CHARACTERISTICS

| Characteristic | Symbol | Value | Unit |
|---|--------|----------------------|----------|
| Maximum Instantaneous Forward Voltage (Note 2) ($I_F = 3.0\text{ A}$, $T_J = 25^{\circ}C$) ($I_F = 4.0\text{ A}$, $T_J = 25^{\circ}C$) ($I_F = 3.0\text{ A}$, $T_J = 150^{\circ}C$) | V_F | 0.84 0.86 0.62 | V |
| Maximum Instantaneous Reverse Current (Note 2) (Rated dc Voltage, $T_J = 25^{\circ}C$) (Rated dc Voltage, $T_J = 150^{\circ}C$) | I_R | 1.0 6.0 | mA mA |

2. Pulse Test: Pulse Width = 300 μs , Duty Cycle $\leq 2.0\%$.

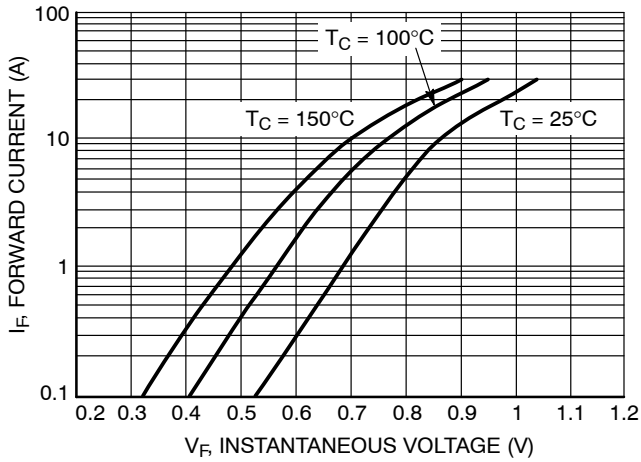

Figure 1. Typical Forward Voltage

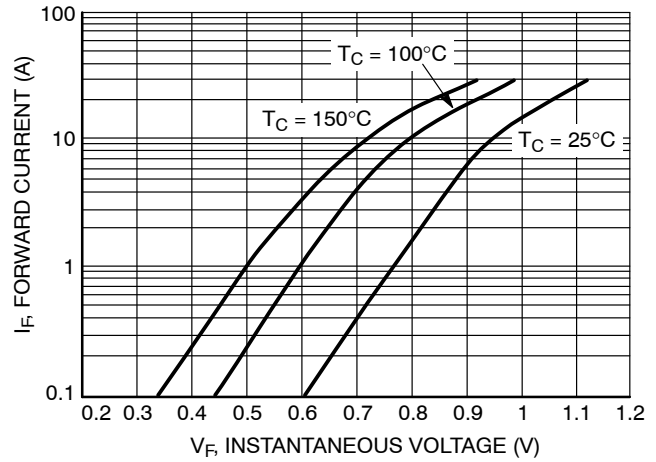

Figure 2. Maximum Forward Voltage

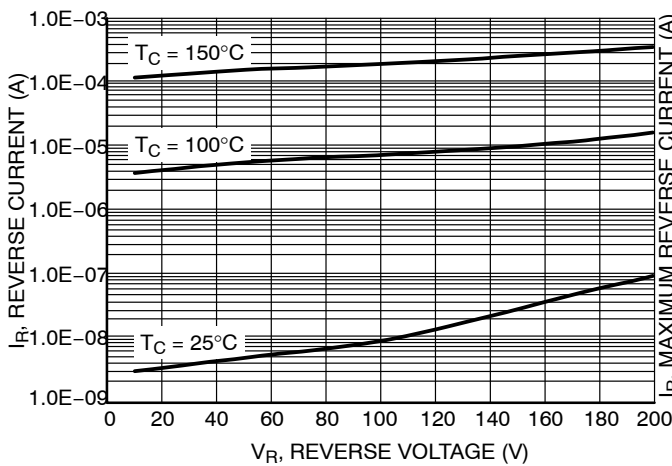

Figure 3. Typical Reverse Current

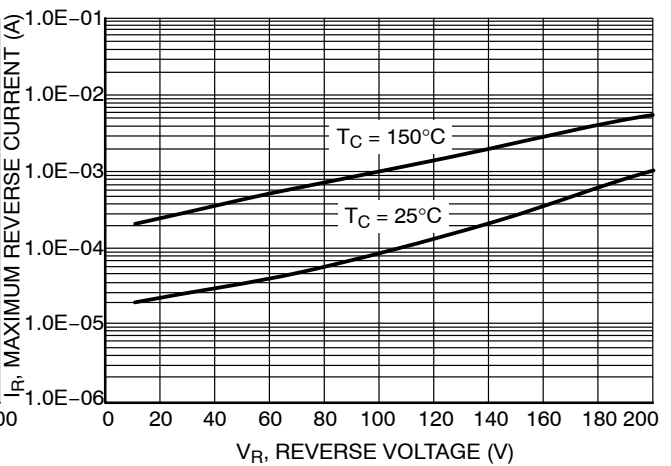

Figure 4. Maximum Reverse Current

MBRAF3200T3G

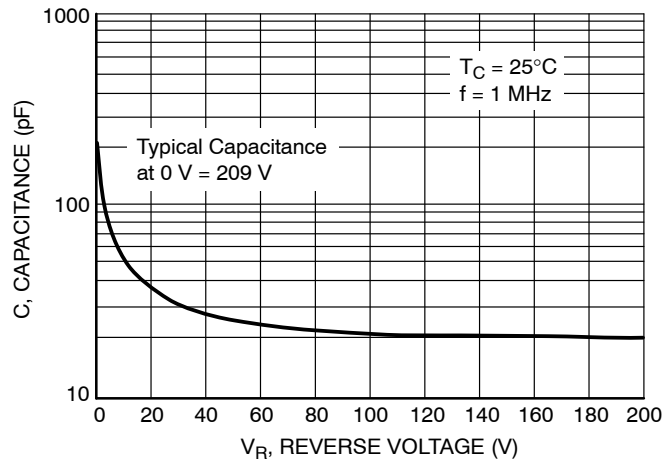

Figure 5. Typical Capacitance

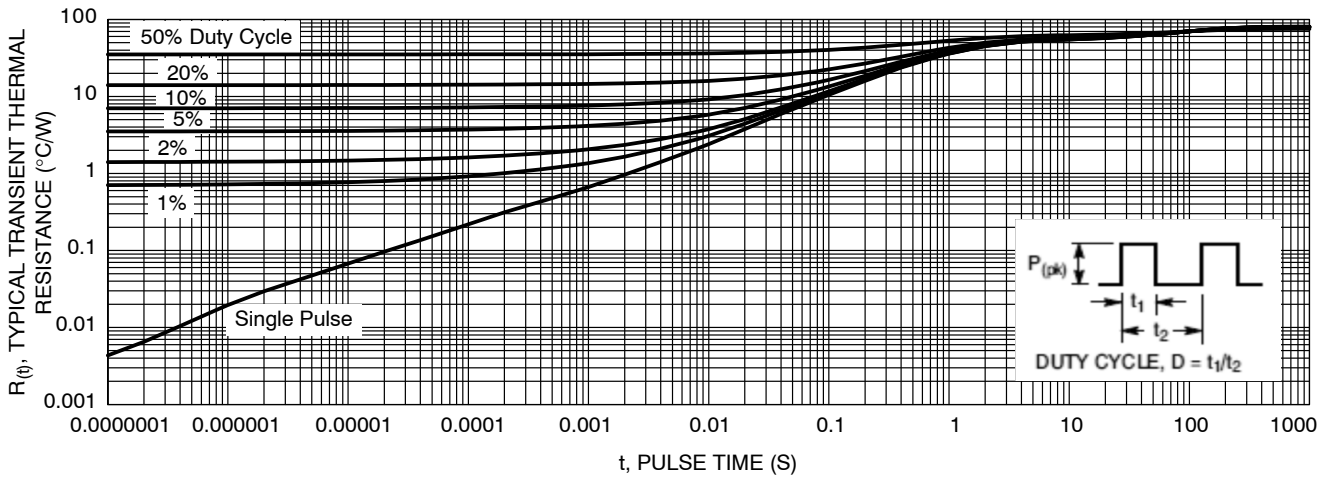
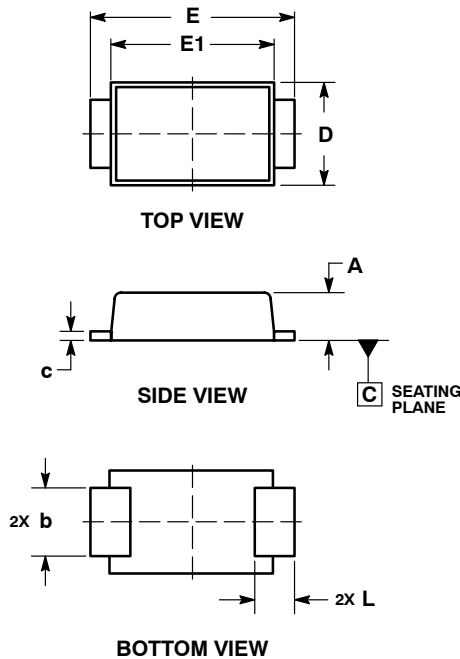

Figure 6. Typical Transient Thermal Response, Junction-to-Ambient

MBRAF3200T3G

PACKAGE DIMENSIONS

SMA-FL
CASE 403AA-01
ISSUE O



- NOTES:
1. DIMENSIONING AND TOLERANCING PER ASME Y14.5M, 1994.
 2. CONTROLLING DIMENSION: MILLIMETERS.

| MILLIMETERS | | |
|-------------|------|------|
| DIM | MIN | MAX |
| A | 0.90 | 1.10 |
| b | 1.25 | 1.65 |
| c | 0.15 | 0.30 |
| D | 2.40 | 2.80 |
| E | 4.80 | 5.40 |
| E1 | 4.00 | 4.60 |
| L | 0.70 | 1.10 |

RECOMMENDED SOLDER FOOTPRINT*

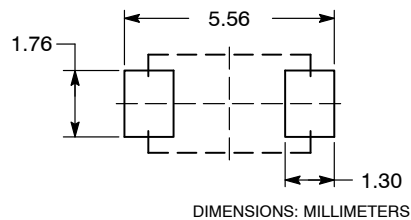

*For additional information on our Pb-Free strategy and soldering details, please download the ON Semiconductor Soldering and Mounting Techniques Reference Manual, SOLDERRM/D.

ON Semiconductor and  are registered trademarks of Semiconductor Components Industries, LLC (SCILLC). SCILLC owns the rights to a number of patents, trademarks, copyrights, trade secrets, and other intellectual property. A listing of SCILLC's product/patent coverage may be accessed at www.onsemi.com/site/pdf/Patent-Marking.pdf. SCILLC reserves the right to make changes without further notice to any products herein. SCILLC makes no warranty, representation or guarantee regarding the suitability of its products for any particular purpose, nor does SCILLC assume any liability arising out of the application or use of any product or circuit, and specifically disclaims any and all liability, including without limitation special, consequential or incidental damages. "Typical" parameters which may be provided in SCILLC data sheets and/or specifications can and do vary in different applications and actual performance may vary over time. All operating parameters, including "Typicals" must be validated for each customer application by customer's technical experts. SCILLC does not convey any license under its patent rights nor the rights of others. SCILLC products are not designed, intended, or authorized for use as components in systems intended for surgical implant into the body, or other applications intended to support or sustain life, or for any other application in which the failure of the SCILLC product could create a situation where personal injury or death may occur. Should Buyer purchase or use SCILLC products for any such unintended or unauthorized application, Buyer shall indemnify and hold SCILLC and its officers, employees, subsidiaries, affiliates, and distributors harmless against all claims, costs, damages, and expenses, and reasonable attorney fees arising out of, directly or indirectly, any claim of personal injury or death associated with such unintended or unauthorized use, even if such claim alleges that SCILLC was negligent regarding the design or manufacture of the part. SCILLC is an Equal Opportunity/Affirmative Action Employer. This literature is subject to all applicable copyright laws and is not for resale in any manner.

PUBLICATION ORDERING INFORMATION

LITERATURE FULFILLMENT:
Literature Distribution Center for ON Semiconductor
P.O. Box 5163, Denver, Colorado 80217 USA
Phone: 303-675-2175 or 800-344-3860 Toll Free USA/Canada
Fax: 303-675-2176 or 800-344-3867 Toll Free USA/Canada
Email: orderlit@onsemi.com

N. American Technical Support: 800-282-9855 Toll Free
USA/Canada
Europe, Middle East and Africa Technical Support:
Phone: 421 33 790 2910
Japan Customer Focus Center
Phone: 81-3-5817-1050

ON Semiconductor Website: www.onsemi.com
Order Literature: <http://www.onsemi.com/orderlit>
For additional information, please contact your local Sales Representative