

## Product Description

RFMD's CXE-2022Z is a 75Ω high performance low noise pHEMT MMIC amplifier utilizing a self bias network. The CXE-2022Z is designed to run over a wide 2.7V to 3.3V single supply voltage and does not require a bias resistor as compared to typical Darlington amplifiers.

The CXE-2022Z was developed for low noise, portable, linear gain block consumer applications which require small size, low current, and a few external components. The part is internally matched to 75Ω and designed to operate over the 50 MHz to 1000 MHz bandwidth.

## Features

- Low Noise Figure: 1.2 dB
- Flat Gain Response: 17.5 dB ± 0.15 dB
- High Linearity IIP3: 0 dBm
- Single Supply: 2.7V to 3.3V
- Low Current: 20 mA

## Applications

- DVB/T Receivers/Antennas
- DMB-T Receivers/Antennas
- PCTV and Other Portable Devices

### Optimum Technology Matching® Applied

- GaAs HBT
- GaAs MESFET
- InGaP HBT
- SiGe BiCMOS
- Si BiCMOS
- SiGe HBT
- GaAs pHEMT
- Si CMOS
- Si BJT
- GaN HEMT
- InP HBT
- RF MEMS
- LDMOS

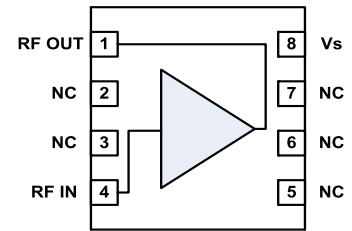
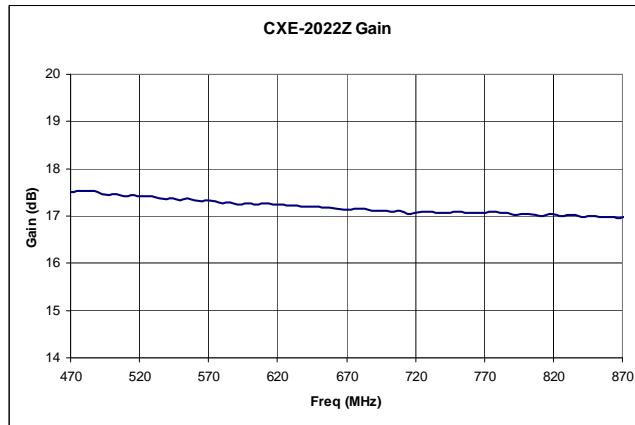

FUNCTIONAL BLOCK DIAGRAM

Parameter	Specification			Unit	Condition
	Min.	Typ.	Max.		
Small Signal Gain	16.5	17.5		dB	500MHz
Gain Flatness		+/- .15		dB	470MHz to 860MHz
Output Power at 1dB Compression		1.3		dBm	500MHz
Input Third Order Intercept Point		0		dBm	500MHz
Input Second Order Intercept Point		10		dBm	500MHz
Input Return Loss		-13.5		dB	50MHz to 860MHz
Output Return Loss		-10		dB	50MHz to 860MHz
Noise Figure		1.2	1.5	dB	500MHz
Device Operating Voltage	2.7		3.6	V	
Device Operating Current	17	20		mA	

Test Conditions:  $V_P=3.3V$ ,  $I_D=20mA$  Typ, IIP<sub>3</sub>, IIP<sub>2</sub> Tone Spacing= 1MHz, P<sub>OUT</sub> per tone=-10dBm, T<sub>L</sub>=25°C, Z<sub>S</sub>=Z<sub>L</sub>=75Ω, Tested with App Circuit

## Absolute Maximum Ratings

Parameter	Rating	Unit
Device Current ( $I_D$ )	35	mA
Device Voltage ( $V_D$ )	3.6	V
Power Dissipation	125	mW
Junction Temperature ( $T_J$ )	+150	°C
Operating Temperature Range ( $T_L$ )	-40 to +85	°C
Storage Temperature Range	-65 to +150	°C
ESD Rating - Human Body Model	Class 0	
Moisture Sensitivity Level	MSL 1	

Operation of this device beyond any one of these limits may cause permanent damage. For reliable continuous operation, the device voltage and current must not exceed the maximum operating values specified in the table on page one.



**Caution!** ESD sensitive device.

Exceeding any one or a combination of the Absolute Maximum Rating conditions may cause permanent damage to the device. Extended application of Absolute Maximum Rating conditions to the device may reduce device reliability. Specified typical performance or functional operation of the device under Absolute Maximum Rating conditions is not implied.

RoHS status based on EU Directive 2002/95/EC (at time of this document revision).

The information in this publication is believed to be accurate and reliable. However, no responsibility is assumed by RF Micro Devices, Inc. ("RFMD") for its use, nor for any infringement of patents, or other rights of third parties, resulting from its use. No license is granted by implication or otherwise under any patent or patent rights of RFMD. RFMD reserves the right to change component circuitry, recommended application circuitry and specifications at any time without prior notice.

## Typical Application Circuit Performance

**Frequency Response**  
Application Circuit #1

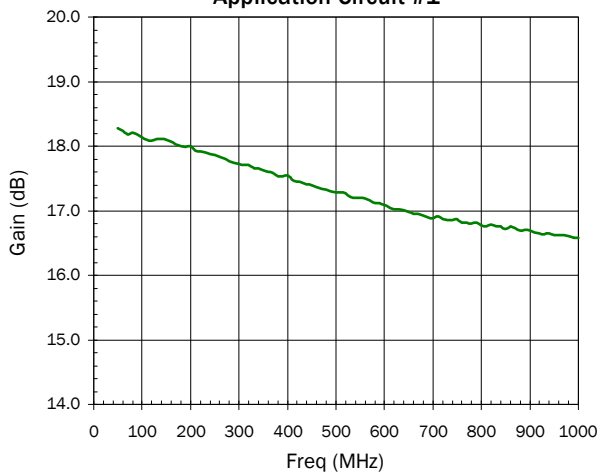

**Frequency Response**  
Application Circuit #2

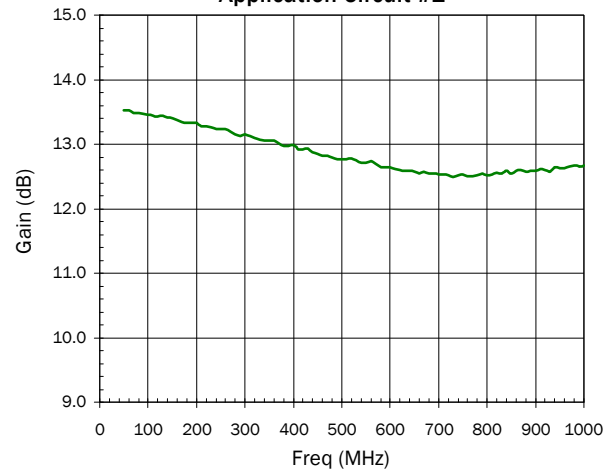

**Return Loss**  
Application Circuit #1

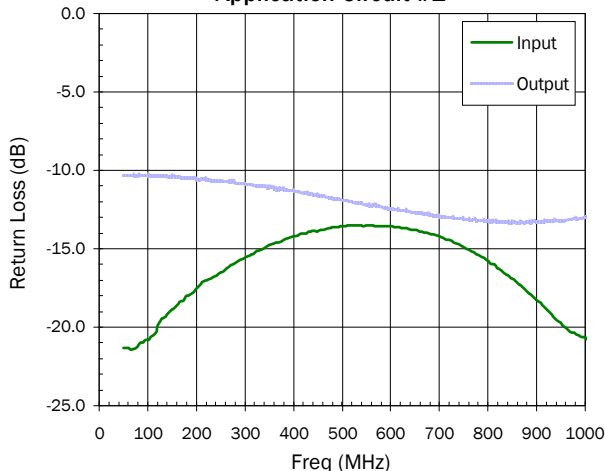

**Return Loss**  
Application Circuit #2

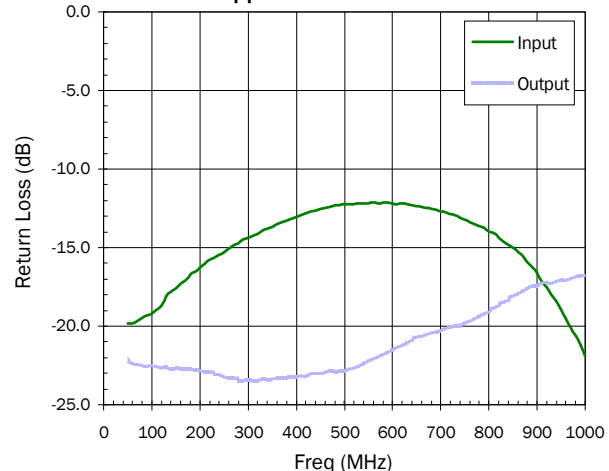

**Noise Figure**  
**Application Circuit #1**

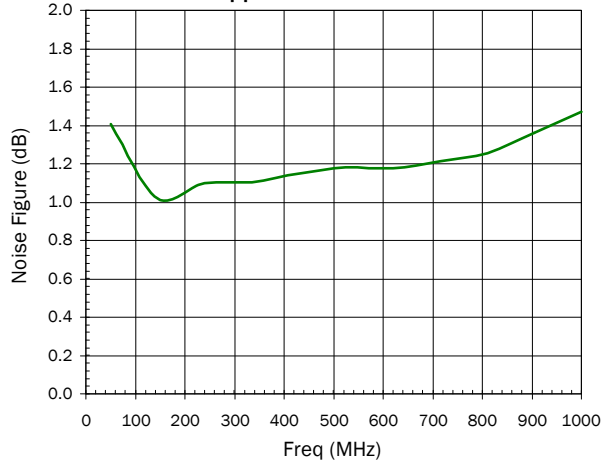

**Noise Figure**  
**Application Circuit #2**

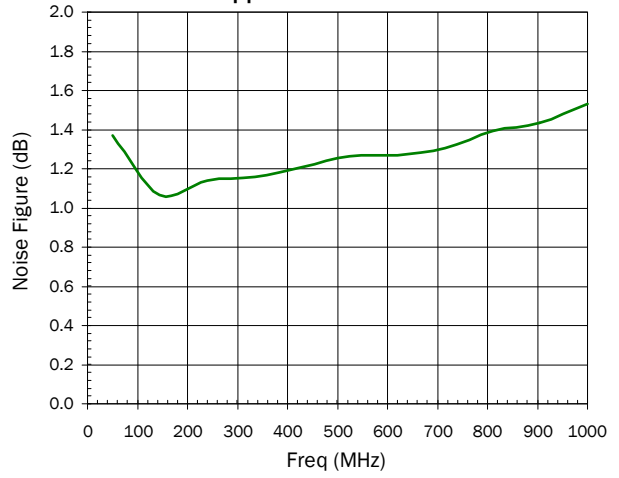

## Application Circuit #1

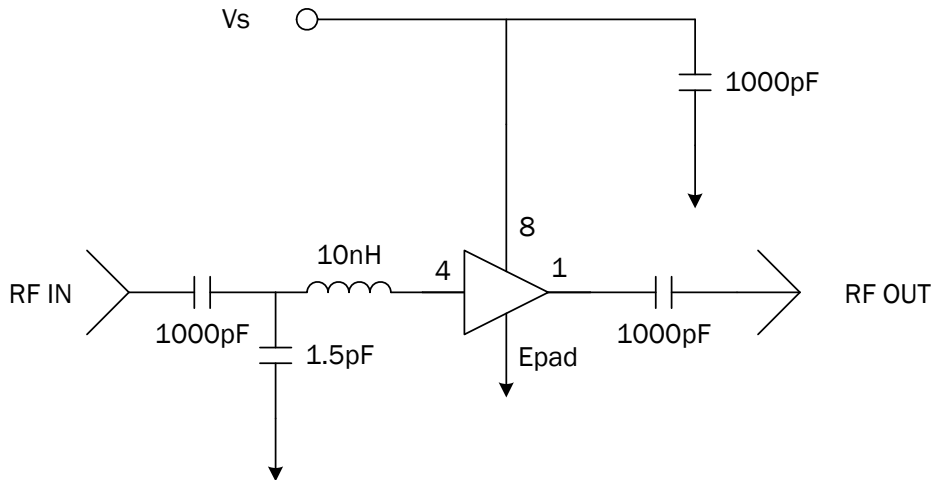

## Application Circuit #2

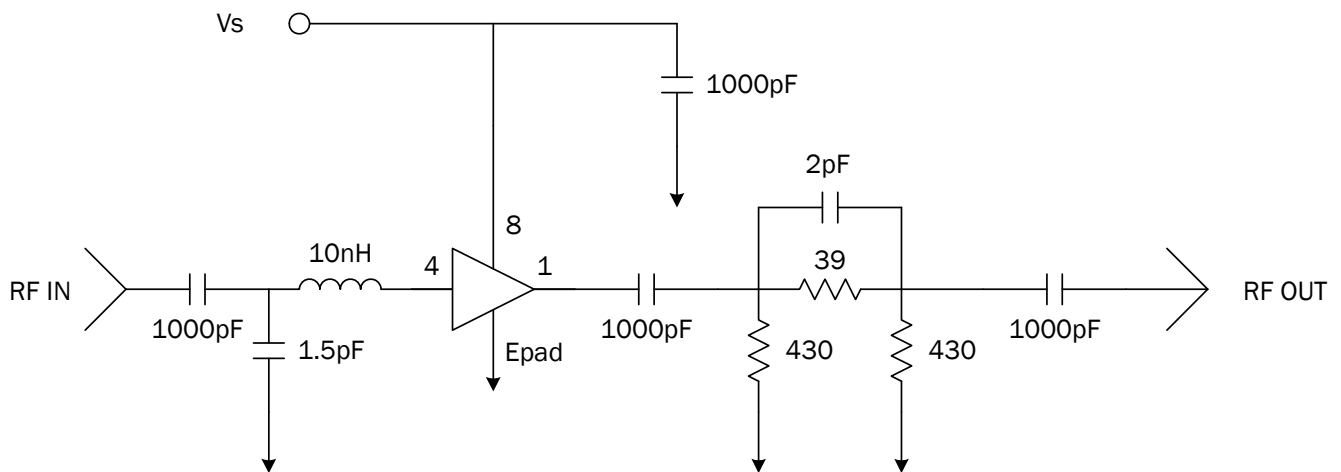

## Pin Description Table

Pin Number	Description
1	RF Output
2	Not connected (NC)
3	Not connected (NC)
4	RF input
5	Not connected (NC)
6	Not connected (NC)
7	Not connected (NC)
8	Voltage Supply Input
Exposed Pad (EP)	Package EP is used to provide IC ground (GND). Follow recommended CXE-2022Z application circuit evaluation board assembly (PCBA) layout.

**Suggested Pad Layout**

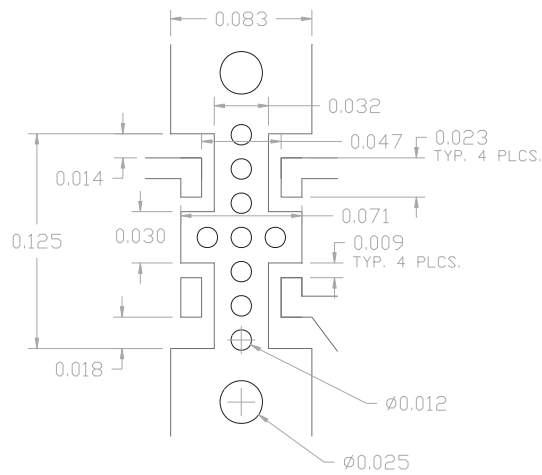

**Standard PCB Assembly**

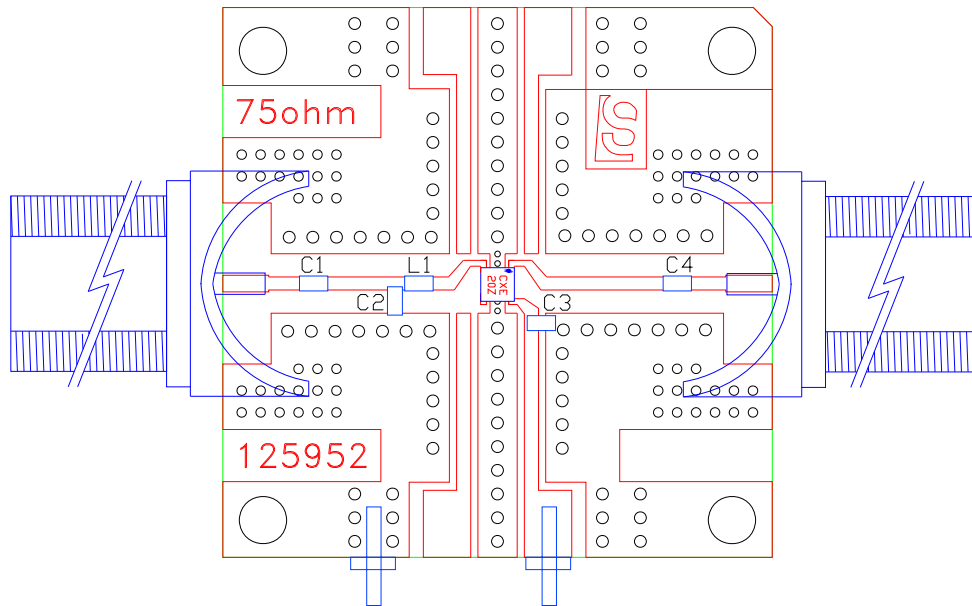

Reference Designator	Component Value 0603
C1, C3, C4	1000pF
C2	1.5pF
L1	10nH

## Package Outline

Dimensions shown in inches [mm]

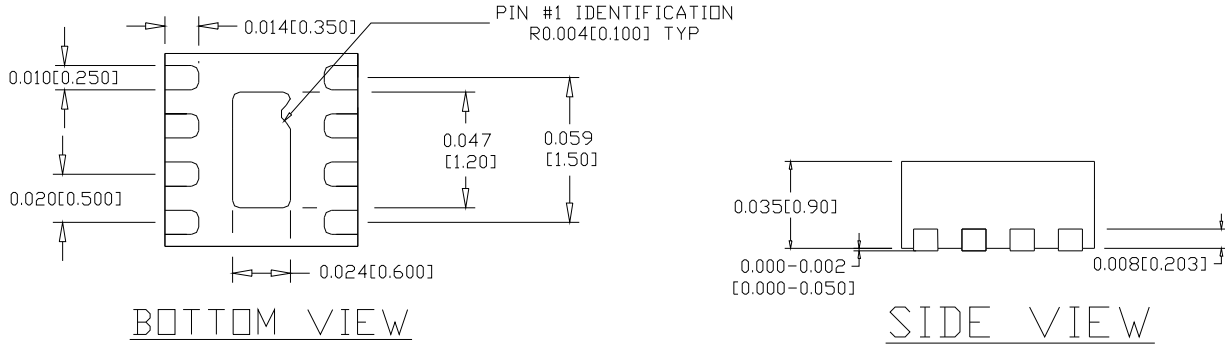

## Package Marking

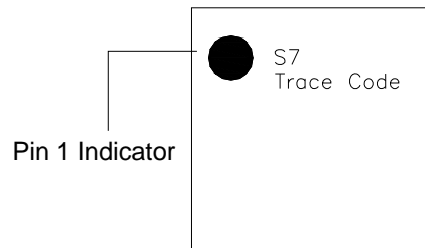

## Ordering Information

Part Number	Description
CXE2022SB	5 pcs Sample Bag
CXE2022SQ	25 pcs Sample Bag
CXE2022SR	100 pcs Tape and Reel
CXE2022TR7	2500 pcs Tape and Reel
CXE2022PCK-410	CXE2022Z 75Ω Evaluation Board and 5pc Sample Bag