

Features

- High Integration 5.8GHz FSK Transceiver
- High Data Range: 1.536Mbps
- Low-IF Receiver Eliminates External IF Filters
- Fully Integrated IF Filters, FM Discriminator, and Data Filters
- Self-Calibrated Filters Eliminate production Tuning
- 4 dB (Typ.) Input-Referred Noise Figure
- -94 dBm (Typ.) Sensitivity at 0.1% BER
- 0dBm (Typ.) output Power
- Simple 3-Wire Control Interface
- PA Sequencing and Integrated Pin Diode Driver
- Analog RSSI Output Over a 68dB Range
- Auxiliary Switch for Transmit Power Control
- “Green” (Pb-Free) 32-Pin QFN Package

Applications

- Digital Cordless Telephones
- Wireless Streaming Audio and Video
- Game Controllers
- High-Speed Data Links

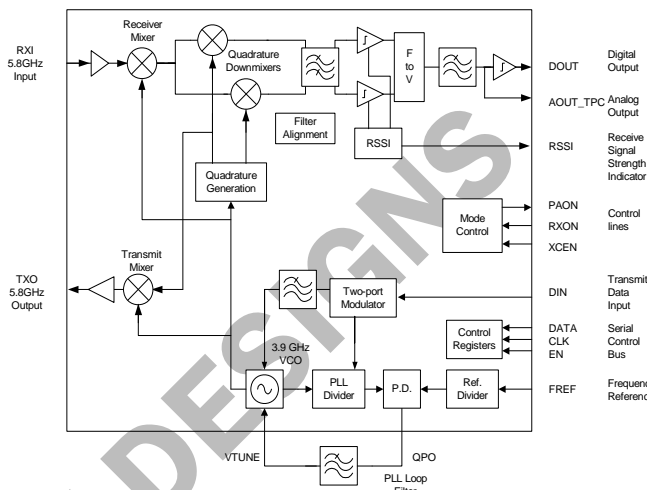

Functional Block Diagram

Product Description

The ML5800 is a high integration 5.8GHz Frequency Shift Keyed (FSK) transceiver that integrates all frequency generation, receive, and transmit functions required to realize a digital cordless telephone. Only a power amplifier (PA) and antenna switch are required to form a complete 5.8GHz digital radio. The ML5800 operates in the 5.725GHz to 5.850GHz unlicensed ISM band. It can be used to implement both Direct Sequence and Frequency Hopping Spread Spectrum radios.

The ML5800 contains a dual-conversion low-IF receiver with all channel selectivity on chip. IF filtering, IF gain, and demodulation are performed on chip eliminating the need for any external IF filters or production tuning. A post detection filter and a data slicer are integrated to complete the receiver.

The ML5800 transmitter uses an adjustment-free two-port closed loop modulator, which modulates the on-chip VCO with filtered data. An upconversion mixer and buffer/predriver produces output of 0dBm at 5.8GHz. A fully integrated 3.9GHz fractional synthesizer is used in both receive and transmit modes. Power supply regulation is included in the ML5800, providing circuit isolation and consistent performance over supply voltages between 2.7V to 3.6V.

Optimum Technology Matching® Applied

- | | | | |
|--------------------------------------|--------------------------------------|-------------------------------------|-----------------------------------|
| <input type="checkbox"/> GaAs HBT | <input type="checkbox"/> SiGe BiCMOS | <input type="checkbox"/> GaAs pHEMT | <input type="checkbox"/> GaN HEMT |
| <input type="checkbox"/> GaAs MESFET | <input type="checkbox"/> Si BiCMOS | <input type="checkbox"/> Si CMOS | <input type="checkbox"/> RF MEMS |
| <input type="checkbox"/> InGaP HBT | <input type="checkbox"/> SiGe HBT | <input type="checkbox"/> Si BJT | |

RF MICRO DEVICES®, RFMD®, Optimum Technology Matching®, Enabling Wireless Connectivity™, PowerStar®, POLARIS™ TOTAL RADIO™ and UltimateBlue™ are trademarks of RFMD, LLC. BLUETOOTH is a trademark owned by Bluetooth SIG, Inc., U.S.A. and licensed for use by RFMD. All other trade names, trademarks and registered trademarks are the property of their respective owners. ©2006, RF Micro Devices, Inc.

Absolute Maximum Ratings

Parameter	Rating	Unit
VCCA, VDD	0.3V to 3.6V	V _{SS}
Junction Temperature	150	°C
Storage Temperature Range	-60 to +150	°C
Lead Temperature (Soldering, 10s)	260	°C



Caution! ESD sensitive device.

Exceeding any one or a combination of the Absolute Maximum Rating conditions may cause permanent damage to the device. Extended application of Absolute Maximum Rating conditions to the device may reduce device reliability. Specified typical performance or functional operation of the device under Absolute Maximum Rating conditions is not implied.

RoHS status based on EUDirective2002/95/EC (at time of this document revision).

The information in this publication is believed to be accurate and reliable. However, no responsibility is assumed by RF Micro Devices, Inc. ("RFMD") for its use, nor for any infringement of patents, or other rights of third parties, resulting from its use. No license is granted by implication or otherwise under any patent or patent rights of RFMD. RFMD reserves the right to change component circuitry, recommended application circuitry and specifications at any time without prior notice.

Parameter	Specification			Unit	Condition
	Min.	Typ.	Max.		
Power Supplies					
Analog supply voltage	2.7	3.3	3.6	V	
Digital supply voltage	2.7	3.3	V _{CCA}	V	V _{DD} pin (V _{CCA} ≥ V _{DD} always)
Bandgap voltage		1.23		V	VBG, I _O = 0 μA
Regulated voltage		2.7		V	V _{CCVCO} , V _{CCRF} , V _{CCTXMIX} , V _{CCIF} , I _O = 0 μA
VCO Regulated Voltage		2.5		V	V _{CCVO} , I _O = 0 μA, V _{CCB} = 2.7V
Supply current, STANDBY mode		0.1		μA	DC supply connected, XCEN low, 25 °C and 3.0V
Supply current, RECEIVE mode		65	90	mA	RX chain active, data being received
Supply current, TRANSMIT mode		60	80	mA	P _{OUT} = 0 dBm
Synthesizer					
Carrier frequency range	5.725		5.850	GHz	
Channel Spacing		512kHz Steps			
Charge Pump skin/source current	±0.22	±0.52	±1.2	mA	
Phase noise at driver output					
f ₀ = 1.2 MHz offset from f _C		-90		dBc/Hz	
f ₀ = 3 MHz offset from f _C		-110		dBc/Hz	
f ₀ > 7 MHz offset from f _C		-120		dBc/Hz	
Lock time for channel switch (2.560MHz channels)					
1 Channel		110		μS	
5 Channels		185		μS	
Full Range		250		μS	
Lock time for TX/RX		70		μS	RXON High to Valid RX data
Lock time for RX/TX		62.5		μS	RXON Low to PAON high
Lock up time from standby		275		μS	XCEN high to Valid RX data, XCEN low period > 120seconds
Reference signal frequency					
		6.144		MHz	
		12.288		MHz	
Reference signal input level	2.0		V _{CCA}	V _{P-P}	6.144 MHz or 12.288 MHz sine wave, capacitively coupled

Parameter	Specification			Unit	Condition
	Min.	Typ.	Max.		
Receiver					
Input Impedance		24.5+j28		Ω	at RXI
Input noise figure		4.0		dB	5.725GHz to 5.850GHz, at RXI
RX Gain		80		dB	5.725GHz to 5.850GHz, RXI to Limiter
Data Rate		1.536		Mbps	
Input Sensitivity		-94		dBm	<0.1%BER
RX Data Filter 3dB Bandwidth		768		KHz	Gaussian 5 th order
Maximum RX RF input		-10		dBm	<0.1%BER at 1.536M _{BIT/SEC}
RX RF input IP ₃		-27		dBm	Test tones 2 and 4 channels away
LO leakage at RXI			-50	dBm	5.8GHz
RX Chain Image rejection ratio		35		dB	
RX adjacent channel(s) rejection					Wanted at -80dBm, 2.56MHz channel spacing
1 channel		15		dB	
2 channels		40		dB	
3 or more channels		45		dB	
Receive Low Filters					
IF filter center frequency		1.024		MHz	Post-alignment
IF filter 3dB bandwidth		1.408		MHz	Post-alignment
Limiter, AGC, and FM Demodulator					
Recovery from overload		20		μ S	Transition time to switch from Pin=-10dBm input to Pin=-90dBm, time to valid RX data
Co-Channel rejection, 0.1%BER		-20		dB	Wanted at Chx -80dBm, unwanted at Chx modulated with 1.536Mbps GFSK, BT=0.5, PRBS data
Quiescent output voltage at A _{OUT_TPC} (pin 7), A _{OUT} Mode		1.15		V	
Output voltage swing A _{OUT_TPC} (pin 7), A _{OUT} Mode		0.8		V _{P-P}	
RSSI					
RSSI rise time. <-100dBm to -15dBm into the RF mixer		5		μ S	20pF loading on the RSSI output. Rise time from 20% to 80%
RSSI fall time. -15dBm to <-10dBm into the IF mixer		5		μ S	20pF loading on the RSSI output. Rise time from 20% to 80%
RSSI maximum voltage		2.7		V	-10dBm into RXI
RSSI midrange voltage		2.5		V	-40dBm into RXI
RSSI minimum voltage		0.2		V	No signal applied
RSSI maximum voltage (clipped)		2.3		V	-10dBm into RXI
RSSI sensitivity		35		mV/dB	(V _{-40dBm} - V _{-50dBm})/10dB
RSSI accuracy		±3		dB	Deviation from best fit straight line
Transmitter					
Output Impedance		22.5+j3		Ω	at TXO
TX buffer output power at 5.8GHz	-4	0	3	dBm	Matched into 50 Ω , 25°C, and 3.3V
	-7	0	3	dBm	Matched into 50 Ω , over operating temperature and voltage range
Transmit Modulation Deviation		±512		kHz	TXO in pin, See figure 6
TX Data Filter 3dB Bandwidth		1.4		MHz	

Parameter	Specification			Unit	Condition
	Min.	Typ.	Max.		
Transmitter, cont.					
TX spurious		-25		dBc	
TX Image		-20		dBc	2/3 F _{TXO} , 1/3 F _{TXO}
Interface Logic Levels					
Input pins (DIN, XCEN, RXON, DATA, CLK, EN)					
Input high voltage	VDD*0.7		VDD+0.4	V	
Input low voltage	-0.4		VDD*0.3	V	
Input bias current	-5		5	μA	All states
Input capacitance		4		pF	1 MHz test frequency
Output pins (AOUT_TPC, PAON, DOUT)					
AOUT open-drain voltage			0.4	V	I _O =100μA, TPC Mode
PAON (PA control) output high voltage	VDD-0.4			V	Sourcing 5.0mA
PAON (PA control) output low voltage			0.4	V	Sinking 5.0mA
PAON source/sink current	±5.0	±8.0		mA	
DOUT (data output) output high voltage	VDD-0.4			V	Sourcing 0.1mA
DOUT (data output) output low voltage			0.4	V	Sinking 0.1mA
3 Wire Serial Bus Timing					
CLK input rise time (note 1)			15	ns	See Figure 5
CLK input fall time (note 1)			15	ns	See Figure 5
CLK period	50			ns	See Figure 5
EN pulse width	200			ns	See Figure 5
Delay from last clock rising edge to rise of EN	15			ns	See Figure 5
EN setup time to ignore next rising CLK	15			ns	See Figure 5
DATA-to-CLK setup time	15			ns	See Figure 5
DATA-to-CLK hold time	15			ns	See Figure 5

Test Conditions: Unless otherwise specified data is over operating conditions (T_A = -10 °C to 60 °C, V_{CCA} = V_{DD} = 2.7V to 3.6V) and f_{REF} = 6.144 MHz, V_{23PLL} = 0, at Freq = 5779.456 MHz (N = 229, P = 0)
 Typical defined as V_{CCA} = V_{DD} = 3.3V, T_A = 25 °C

Note 1: Serial I/O clock maximum rise and fall times are based on the minimum clock period. Longer rise and fall times can be accommodated for slower clocks provided the rise and fall times remain less than 20% of the clock period and all set up and hold time minimums are met with respect to the CMOS switching points (V_{IL} MAX and V_{IH} MIN). The serial I/O clock rise and fall times are limited to an absolute maximum of 100ns.

Parameter	Specification			Unit	Condition
	Min.	Typ.	Max.		
Operating Conditions					
Ambient Temperature Range	-10		60	°C	
V _{CCA} Range	2.7		3.6	V	
V _{DD} Range	2.7		3.6	V	
Thermal Resistance		36		°C/W	
Maximum Receive RF input power		-10		dBm	

Pin	Function	Description	Interface Schematic
1	XCEN	Transceiver enable input. Enables the bandgap reference and voltage regulators when high. Consumes only leakage current in STANDBY mode when low. This is a CMOS input, and the thresholds are referenced to VDD and VSS.	
2	RXON	TX/RX Control Input. Switches the transceiver between TRANSMIT and RECEIVE modes. Circuits are powered up and signal paths reconfigured according to the operating mode. This is a CMOS input, and the thresholds are referenced to VDD and VSS.	
3	PAON	PA Control Output. Enables the off-chip PA at the correct times in a Transmit slot. Goes high when transmit RF is present at TXO; goes low 5µs before transmit RF is removed from TXO. This output has 5mA drivers suitable for driving pin diode switches directly. It also has optional interlock logic to disable the PA when the PLL is out of lock.	
4	EN	Control Bus Enable. Enable pin for the three-wire serial control bus that sets the operating frequency and programmable options. The control registers are loaded on a low-to-high transition of the signal. Serial control bus data is ignored when this signal is high. This is a CMOS input, and the thresholds are referenced to VDD and VSS.	
5	DATA	Serial Control Bus Data. 16-bit words, which include programming data and the two-bit address of a control register. This is a CMOS input, and the thresholds are referenced to VDD and VSS.	
6	CLK	Serial control bus data is clocked in on the rising edge when EN is low. This is a CMOS input; the thresholds are referenced to VDD and VSS.	
7	AOUT_TPC	Multi-function Output. In Analog output mode this output drives an off chip data slicer. In Transmit power control mode this is an open drain output, which is pulled low when the TPC bit (R0:B7) is set to 0. Transitions on TPC are synchronized to the falling edge of RXON (Rx to Tx transition).	
8	VSS	Digital Ground. Ground for digital I/O circuits and control logic.	
9	FREF	Input for the 12.288 MHz or 6.144 MHz reference frequency. This input is used as the reference frequency for the PLL and as a calibration frequency for the on-chip filters. An AC-coupled sine or square wave source drives this self-biased input. The reference source must be accurate to 20PPM.	

Pin	Function	Description	Interface Schematic
10	VCCPLL	PLL Supply. DC power supply decoupling point. This pin is connected to the output of the regulator and to the PLL supplies. A capacitor must be tied between this pin and ground to decouple (bypass) noise and to stabilize the regulator.	See Pin 11.
11	QPO	Charge Pump Output of the phase detector. This is connected to the external PLL loop filter.	
12	GNDPLL	Ground for the PLL.	
13	VCCB	Regulated DC Power Supply Input to the VCO voltage regulator. Must be connected to VCCIF (pin 29) via decoupling network.	
14	VCCVCO	DC power supply decoupling point for the VCO. Connected to the output of the VCO regulator. A capacitor must be tied between this pin and ground to decouple (bypass) noise and to stabilize the regulator.	
15	VTUNE	VCO Tuning Voltage input from the PLL loop filter. This pin is very sensitive to noise coupling and leakage currents.	
16	GNDLO	DC ground for VCO and LO circuits.	
17	GNDMIX	Signal ground for the receive mixers.	
18	VCCRXMIX	Regulated RX mixer DC supply input. A capacitor must be tied between this pin and ground to decouple (bypass) noise. Must be connected to VCCTX-MIX (pin 27).	
19	VCCLNA	Regulated RX mixer DC supply input. A capacitor must be tied between this pin and ground to decouple (bypass) noise. Must be connected to VCCTX-MIX (pin 27).	
20	RXI	Receive RF Input. A simple matching network is required for optimum noise figure. This input connects to the base of an NPN transistor and should be AC coupled.	

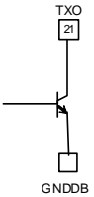
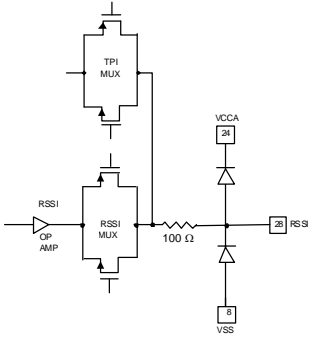
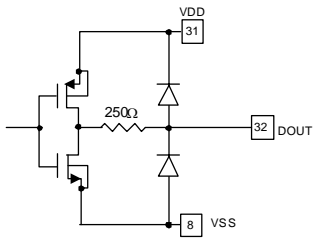
Pin	Function	Description	Interface Schematic
21	TXO	TX RF open-collector output. 0dBm nominal output power into a matched load over 5.725GHz to 5.850GHz range. This output requires a DC path to VCCA.	
22	GNDTX	Signal ground for the transmitter.	
23	VCCRF	DC power supply decoupling point for the LO chain. Connected to the output of a regulator. A capacitor must be tied between this pin and ground to decouple (bypass) noise and to stabilize the regulator.	
24	VCCA	Unregulated DC power supply input to voltage regulators and unregulated loads: 2.7V to 3.6V. VCCA is the main (or master) analog VCC pin. There must be capacitors to ground from this pin to decouple (bypass) supply noise.	
25	GNDIF	DC ground to IF circuits.	
26	VBG	Bandgap decouple voltage. Decoupled to ground with capacitor.	
27	VCCTXMIX	DC power supply output and decoupling point for TX mixer regulator. A capacitor must be tied between this pin and ground to decouple (bypass) noise and to stabilize the regulator.	
28	RSSI	Buffered analog RSSI output with a nominal sensitivity of 35mV/dB.	
29	VCCIF	DC power supply output and decoupling point for the IF regulator. A capacitor must be tied between this pin and ground to decouple (bypass) noise and to stabilize the regulator.	
30	DIN	Transmit Data Input. Drives the transmit pulse shaping circuits. Serial digital data on this pin becomes FSK modulation on the Transmit RF output. The logic timing on this pin controls data timing. Internal circuits determine the modulation deviation. This is a standard CMOS input referenced to VDD and VSS.	See Pin 1.
31	VDD	DC digital power supply input to the interface logic and control registers. This supply is not connected internally to any other supply pin, but its voltage must be less than or equal to the VCCA supply and greater than or equal to 2.7V. A capacitor must be tied between this pin and ground to decouple (bypass) noise.	
32	DOUT	Serial digital output after demodulation, chip rate filtering and center data slicing. A CMOS level output (VSS to VDD) with controlled slew rates. A low drive output designed to drive a short PCB trace and a CMOS logic input while generating minimal RFI. The internal data slicer is limited to 0 or 1 run lengths of less than 3uS.	
33	GND	Ground for exposed die paddle.	

Pin Configuration

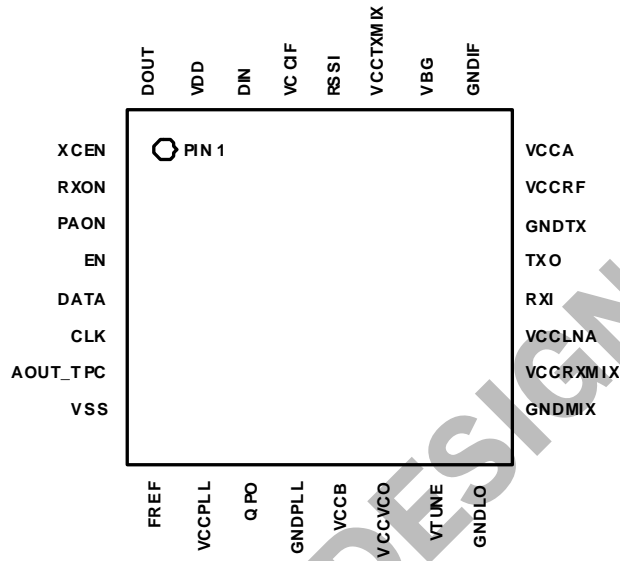

NOT FOR NEW DESIGNS

Simplified Applications Diagram

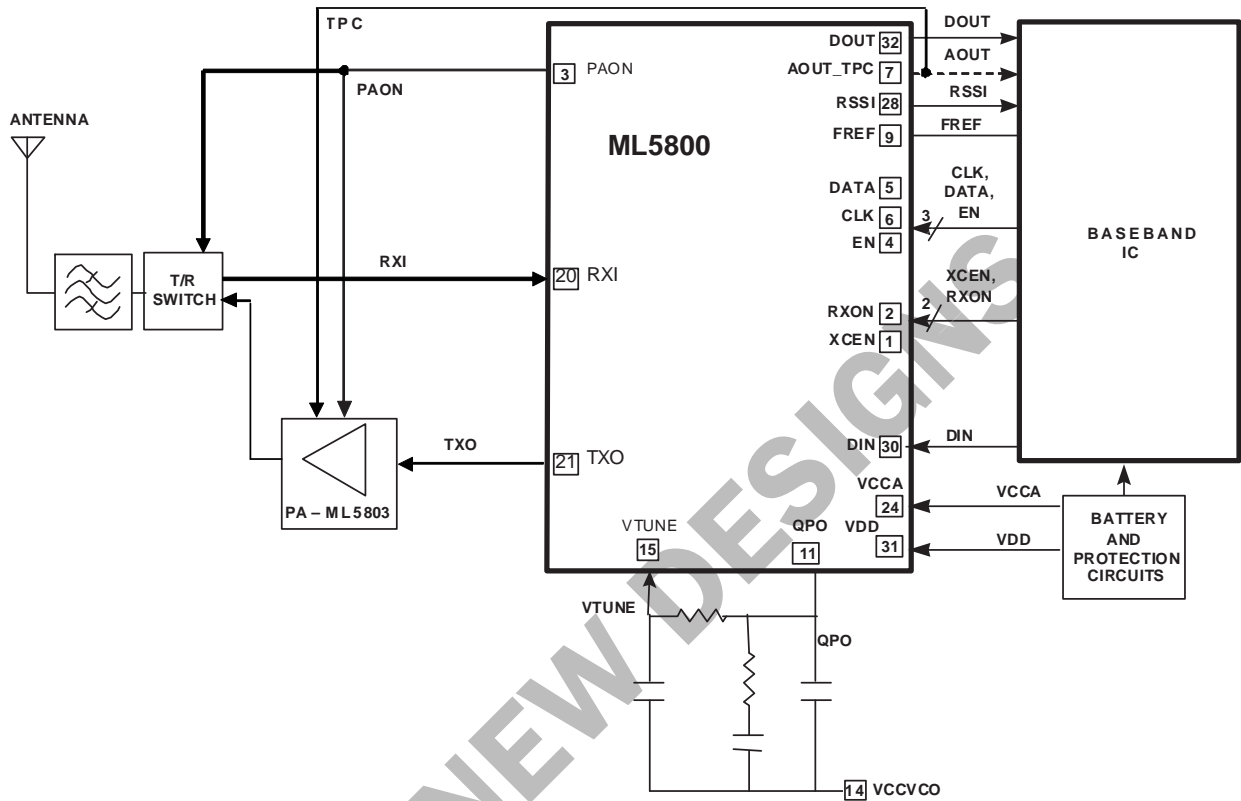

NOT FOR NEW DESIGNING

Functional Description

The ML5800 enables the design and manufacture of low-cost, small yet high-performance digital RF transceivers in the relatively interference-free 5.8GHz ISM band. Frequency Shift Keying (FSK) is a constant-envelope modulation, which allows the use of high-efficiency class C power amplifier (such as the ML5803) resulting in longer battery life. Integrated in the ML5800 is a dual-conversion low-IF receiver with completely integrated filters, all frequency generation circuits, and transmit circuits. On-chip regulators protect critical circuits from power-supply noise and allow for consistent performance over the supply voltage range.

The ML5800 transmits and receives 1.536Mbps FSK data in the 5.725GHz to 5.850GHz ISM band. The high data rate allows for direct sequence spread spectrum coding, which increases interference rejection and input sensitivity at the cost of reduced effective data rate. For example, a 15-chip spreading sequence results in 11.7dB of processing gain and a 'raw' data rate of 102.4kbps.

The ML5800 contains a dual-conversion low-IF receiver. The first IF frequency of 1.9GHz gives an image response, also at 1.9GHz. An off-chip filter is needed to protect the receiver from this image and from IF feed through. The second IF frequency of 1.024 MHz results in an image response in an adjacent channel. The quadrature image-reject mixer and low IF filter combine to achieve a typical image rejection of 35dB. All IF filtering and demodulation are performed on chip using active filtering, centered at 1.024MHz. A matched bit-rate filter and data slicer follow the demodulator and provide sliced data at the DOUT pin. Buffered analog (unsliced) data is available on the AOUT_TPC pin.

The ML5800 transmitter uses a fractional-N PLL and two-port closed loop modulation to accurately impress the FSK signal on the 5.8GHz carrier. Closed loop modulation techniques allow for continuous transmission or reception of data without significant frequency drift, making the ML5800 ideal for wireless streaming media applications. A lock-detect circuit monitors the state of the PLL loop. When the PLL is out of lock the transmitter output is disabled.

The frequency generation circuits are comprised of a fully integrated 3.9GHz VCO local oscillator (LO), dividers, a phase comparator, and a charge pump for a PLL frequency synthesizer. A fractional-N PLL applies the low frequency data modulation onto the LO. The LO is halved to generate accurate quadrature signals at 1.9GHz for the second LO. The LO PLL is programmed via the three-wire serial bus (CLK, DATA, EN). There is no error checking of the program data. This bus is functional, and register contents are preserved in STANDBY mode.

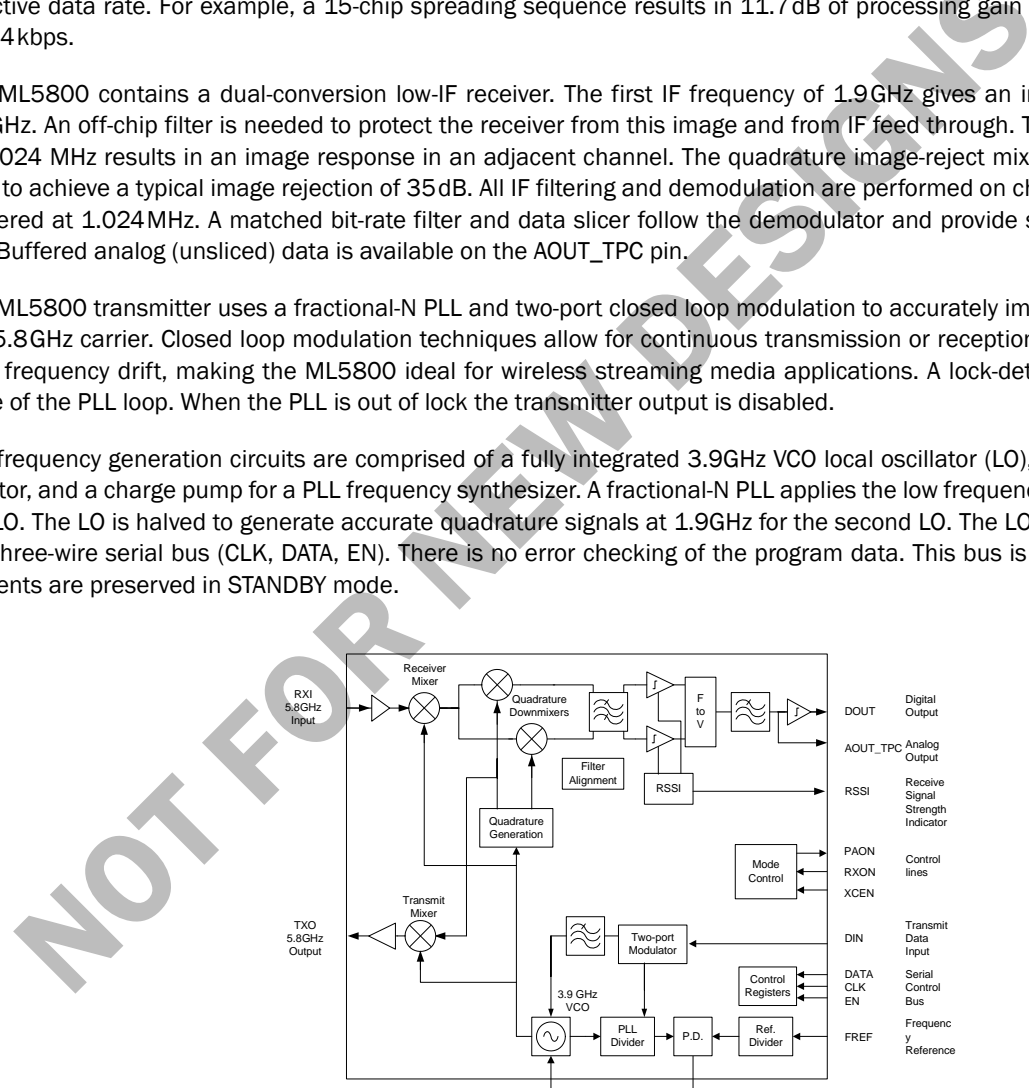

Figure 1. ML5800 Block Diagram

Modes of Operation

The ML5800 has three key modes of operation:

- Standby: All circuits powered down, except the control interface (static CMOS)
- Receive: Receiver circuits active
- Transmit: Transmitter circuits active

Mode Control

The two modes of operational are RECEIVE and TRANSMIT, controlled by RXON. XCEN is the chip enable/disable control pin, which sets the device in operational or STANDBY modes. The relationship between the parallel control lines and the mode of operation of the IC is summarized in Table 1.

XCEN	RXON	Mode Name	Function
0	X	STANDBY	Control interfaces active, all other circuits powered down.
1	1	RECEIVE	Receiver time slot
1	0	TRANSMIT	Transmit time slot

STANBY Mode

In STANDBY mode, the ML5800 transceiver is powered down. The only active circuits are the control interfaces, which are static CMOS to minimize power consumption. The serial control interface and control registers remain powered up and will accept and retain programming data as long as the VDD and VCCA are present. When exiting STANDBY mode, remain in RECEIVE mode for at least 62.5 μ s (typ) to allow for filter calibration.

RECEIVE Mode

In RECEIVE mode, the received signal at 5.8GHz is down converted, bandpass filtered (IF filter), fed to the frequency-to-voltage converter, and low-pass filtered. The output of the low-pass filter is available at both the AOUT_TPC pin and to the on-chip data slicer, which outputs NRZ digital data to the DOUT pin. An RSSI voltage output indicates the RF input signal level at the output of the IF filter.

Receive Signal Strength Indication (RSSI)

RSSI is an indication of field strength. It can be used by the system to determine transmit power control (conserve battery life) and/or to determine if a given channel is occupied.

Automatic Filter Alignment

When the chip is powered up the tuning information is reset to mid-range. In the first 62.5 μ s of RECEIVE mode (RXON set high) the ML5800 performs filter self-calibration, which tunes all the internal filters relative to the signal on the FREF pin. Valid data is received after calibration is completed. Self-calibration sets:

- Discriminator center frequency
- IF filter center frequency and bandwidth
- Receiver data low-pass filter bandwidth
- Transmit data low-pass filter bandwidth

TRANSMIT Mode

In TRANSMIT mode, the PLL loop is closed to eliminate frequency drift. A two-port modulator modulates both the VCO and the fractional-N PLL. The VCO is directly modulated with filtered FSK transmit data. The PLL is driven by a sigma-delta modulator, which ensures that the PLL follows the mean frequency of the modulated VCO.

PLL Programming and Channel Selection

The ML5800 PLL is programmed with a 14bit word to set the RF center frequency of the radio. The channel frequency (fc) is given by:

$$f_c = 1.5 * 6.144 * (512 + N/2 + (P+11)/18) \text{ MHz}$$

Where N is the “integer” portion and P is the “fractional” portion of the synthesizer. See Register 1 Description for further details on how to program the channel frequency plan in the control register.

Control Interfaces

There are two sets of control interfaces for the ML5800:

- RF Control: XCEN, RXON, FREF, RSSI, PAON, AOUT_TPC
- Serial Bus Control: EN, DATA, CLK

The ML5800 transceiver is used in time division duplex (TDD) mode, where the transceivers at each end of a radio link alternately transmit and receive. Immediately before data is transmitted or received the ML5800 goes through a ‘self-calibration’ sequence, where the IF and data filters are frequency aligned while the PLL settles to the carrier frequency. These calibration cycles are triggered by logic transitions on the control interface. Figure 2 shows the normal operating cycle for the ML5800.

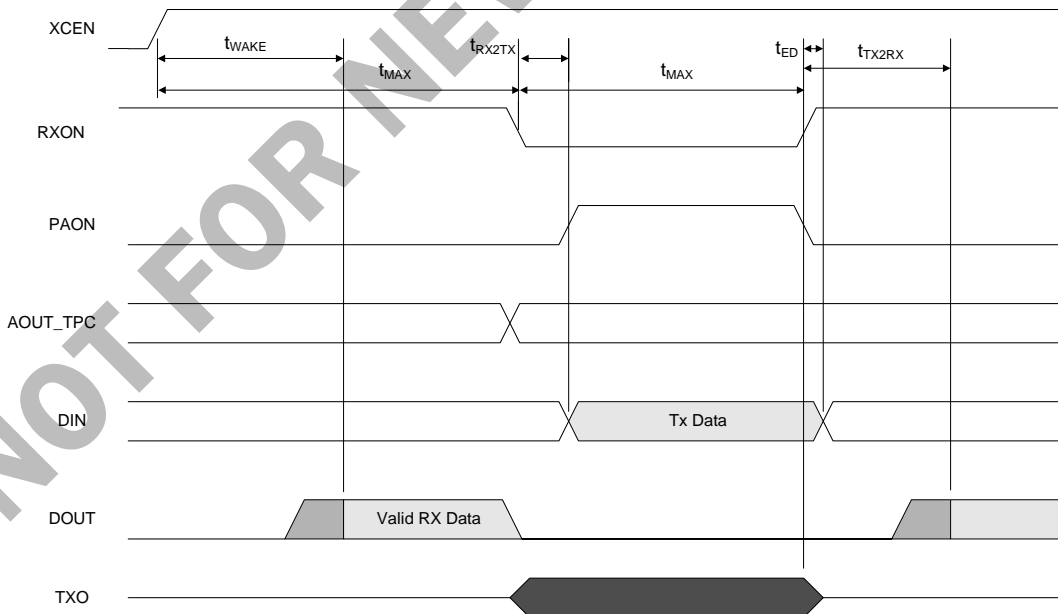

Figure 2. Control Timing for TDD Operation

To implement channel scanning, the ML5800 is kept in RECEIVE mode (XCEN and RXON high) and the PLL is reprogrammed to select a different RF channel. A filter calibration cycle is initiated by each serial bus write to the register controlling the PLL modulus, so that filter alignment is updated as the VCO settles to the next programmed channel frequency. Serial bus writes to other registers do not trigger a calibration cycle. Signal diagram for channel scanning is shown in Figure 3.

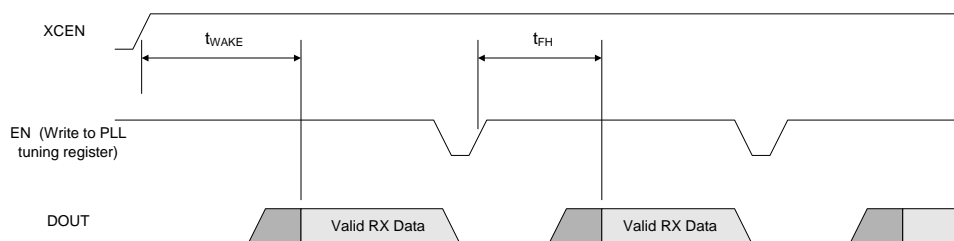

Figure 3. Control Timing When Channel Scanning

Table 2 gives the minimum times between transitions on the control interface for the ML5800 transceiver to work correctly. Times t1, t2, and t4 are the minimum delays that the baseband design must allow before valid receive data is expected on the DOUT pin.

Table 2. Transceiver Control Interface Timing

Symbol	Parameter	Worst Case Timing	Units
t _{WAKE}	Wait time from XCEN asserted to valid Receive data out	325	μs
t _{FH}	Time from rising edge of Serial Bus EN to valid Receive data out (channel scan mode, one channel hop, PLL re-locking triggered by rising EN).	125	μs
t _{TX2RX}	Time from rising edge of RXON to valid Receive data out	120	μs
t _{RX2TX}	Time from falling edge on RXON to start of valid data on DIN pin. Note that RF energy will be present on TXO during this period but PAON will be unasserted.	62.5	μs
t _{MAX}	Maximum TX or RX time under steady state operating temperatures (<±2° C/minute)	60	s
t _{ED}	Time from rising edge on RXON to end of valid data on DIN pin (Start of PLL Freq. shift)	6	μs

RF CONTROL: XCEN, RXON, FREF, RSSI, PAON & TPC

The XCEN pin enables/disables the ML5800 and places the device in either standby or active modes. The default power up is in RECEIVE mode.

The RXON pin determines which active mode the ML5800 is in: RECEIVE or TRANSMIT.

The FREF pin is the master reference frequency for the transceiver. It supplies the frequency reference for the RF channel frequency and the on-chip filter tuning. The FREF pin is a CMOS input with on-chip biasing resistors. It can be driven by an AC coupled sine-wave source or by a CMOS logic output. FREF is used as a calibration frequency and as a timing reference in the control circuits. The reference source must be accurate to 20PPM.

The RSSI pin supplies a voltage that indicates the amplitude of the received RF signal. It is connected to the input of a low-speed ADC on the baseband IC, and is used during channel scanning to detect clear channels on which the radio can transmit. The RSSI (Received Signal Strength Indicator) voltage is proportional to the logarithm of the received power level.

The ML5800 has two output pins that control and sequence the power amplifier (PA): PAON and AOUT_TPC.

The PAON (PA control) is a 5mA CMOS output that controls an off-chip RF PA and T/R switch (can directly drive PIN diodes). It outputs a logic high when the PA should be enabled and a logic low at all other times. This output is inhibited when the PLL fails to lock.

When digital data output (DOUT) is used, the AOUT_TPC pin is an open-drain output intended for transmit power control (TPC). It is configured by Bit 4 in Register 0 (AOUT) and when selected as a TPC output, reflects the state of Bit 7 in Register 0 (TPC). The TPC register bit can be changed at any time, but the AOUT_TPC pin does not change state until the beginning of the next

transmit slot, triggered by a falling edge on RXON. In analog data output mode, the AOUT_TPC pin becomes the analog data output to an off-chip data slicer.

SERIAL BUS CONTROL: EN, DATA, CLK

A three-wire serial interface is used for programming the ML5800 configuration registers, which control device mode of operation, pin functions, PLL and reference dividers, internal test modes and filter alignment. Data words are entered beginning with the MSB. The word is divided into a leading 14-bit data field followed by a 2-bit address field. When the address field has been decoded the destination register is loaded on the rising edge of EN. Providing less than 16 bits of data will result in unpredictable behavior when EN goes high.

Data and clock signals are ignored when EN is high. When EN is low, data on the DATA pin is clocked into a shift register by rising edges on the CLK pin. The information is loaded into the addressed latch when EN returns high. This serial interface bus is an industry standard bus commonly found on PLL devices. It can be efficiently programmed by either byte or 16-bit word oriented serial bus hardware. The data latches are implemented in CMOS and use minimal power when the bus is inactive. See Figure 4 and Table 3.

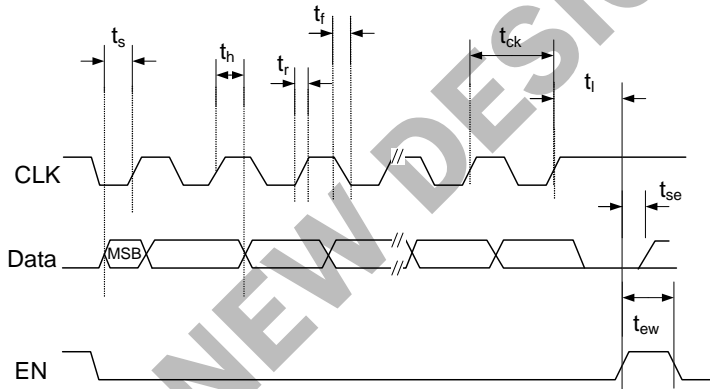

Figure 4: Serial Bus Timing Diagram

Table 3. Serial Bus Timing Specifications

Symbol	Parameter	MIN	MAX	Units
Bus Clock (CLK)				
t_r	Clock input rise time (note 1)		15	ns
t_f	Clock input fall time (note 1)		15	ns
t_{clk}	Clock period	50		ns
Enable (EN)				
t_{ew}	Minimum pulse width	200		ns
t_r	Delay from last clock rising edge to rise of EN	15		ns
t_{se}	Enable set up time to ignore next rising clock	15		ns
Bus Data (DATA)				
t_r	Data to clock set up time	15		ns
t_h	Data to clock hold time	15		ns

Note 1: Serial I/O clock maximum rise and fall times are based on the minimum clock period. Longer rise and fall times can be accommodated for slower clocks provided the rise and fall times remain less than 20% of the clock period and all set up and hold time minimums are met with respect to the CMOS switching points (VIL MAX and VIH MIN). The serial I/O clock rise and fall times are limited to an absolute maximum of 100ns.

Transmit and Receive Data Interfaces

There are two sets of transmit and receive data interfaces for the ML5800:

- Baseband Data: DIN, DOUT, AOUT
- RF Data: RXI, TXO

Baseband Data: DIN, DOUT, AOUT

The DIN pin is a CMOS-level serial data input for FSK modulation on the radio channel. This DIN pin drives data bits into the two-port transmit modulator. When used with Direct Sequence Spread Spectrum (DSSS), the chip rate, bit rate and spreading code are determined in the baseband processor and the FM deviation and transmit filtering are determined in the ML5800. There is no re-timing of the chips, so the transmitted FSK chips take their timing from the data on this pin.

The DOUT pin is a corresponding CMOS-level digital data output. The data on this pin is valid only when the run length of the transmitted digital data is limited to consecutive 1's or 0's no longer than 3µs.

When longer run lengths are used, an off-chip data slicer is required, driven from the AOUT_TPC pin. Setting the AOUT bit in Register 0 turns the AOUT_TPC pin into a buffered, single-ended analog output from the data filter. This output can be used to drive an off-chip data slicer or an ADC input for a DSP data slicer. Clock recovery for both DOUT and AOUT modes is performed in the baseband.

RF DATA: RXI, TXO

The RXI receive input (pin 20) and the TXO transmit output (pin 21) are the only RF I/O pins. The RXI pin requires a simple impedance matching network for best input noise figure, and the TXO pin also requires a matching network for maximum power output into 50Ω. The voltage on the modulation port swings above and below its central value to produce 2-FSK modulation on the VCO (See Figure 5).

For best performance, all RF ground pins must have a direct connection to the RF ground plane, and the RF supply pins must be well decoupled from the RF ground pins.

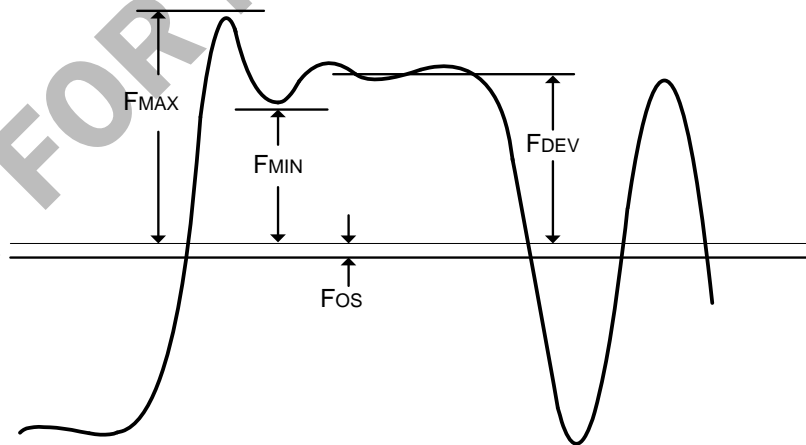

Figure 5

Transient Transmit Modulation Freq=5.779456GHz, VCCA=VDD=3.3V, Ta=25°C						
Name	Description	Conditions	MIN	TYP	MAX	Units
F _{DEV}	Final Modulation Deviation	After 200us of consecutive 1 or 0 bits	±500	±512	±524	kHz
F _{MAX}	Maximum Modulation Deviation	PN (15 bit) Sequence Encoded Data at 1.536Mb/s		±720		kHz
F _{MIN}	Minimum Modulation Deviation	PN (15 bit) Sequence Encoded Data at 1.536Mb/s		±450		kHz
F ₀₈	Modulation center frequency offset	50us after RXON low		±50		kHz

Register Descriptions

A three-wire serial data input bus sets the ML5800's transceiver parameters and programs the PLL circuits. Entering 16-bit words into the ML5800 serial interface performs programming. Three 16-bit registers are partitioned such that 14 bits are dedicated for data to program the operation and two bits identify the register address. The contents of these registers cannot be read back.

The three registers are:

- Register 0:PLL Configuration
- Register 1:RF Channel Frequency Configuration
- Register 2:Test Mode Access

Figure 6 shows a register map. Table 4 through Table 21 provide detailed diagrams of the register organization: Table 4 outlines the PLL configuration register (Register 0), Table 17 describes the channel frequency register (Register 1), and displays the filter tuning and test mode register (Register 2).

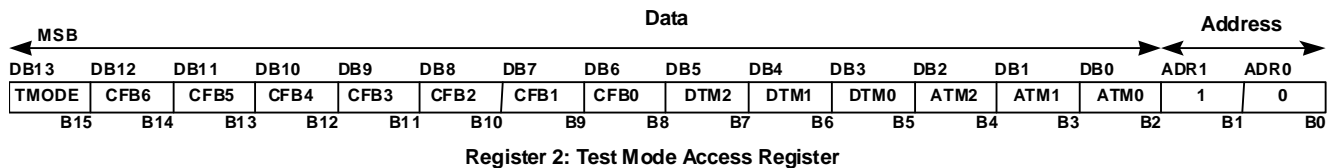
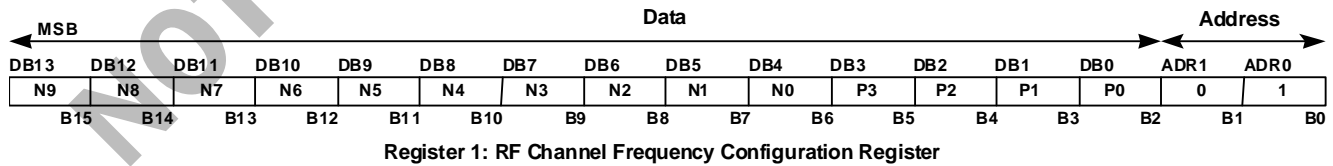
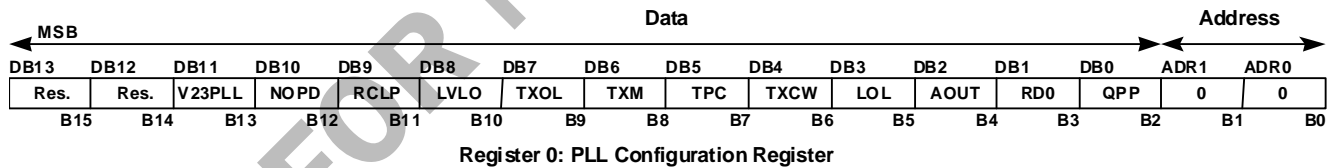

Figure 6. Configuration Register Map

Power-On State

On power up, all register bits are cleared to the default value of 0 (zero). Power up is defined as occurring when $VDD \geq 2.0V$. The register default values are valid upon power up.

Register Format

The two least significant bits of every register are the address bits ADR <1:0>. Each register is divided into a data field and address field. The data field is the leading field, while the last two bits clocked into the register are always the address field. When EN goes high, the address field is decoded and the addressed destination register is loaded. The last 16 bits clocked into the serial bus are loaded into the register. Clocking in less than 16 bits may result in an incorrect entry into the register.

NOT FOR NEW DESIGNS

Register 0 Bit Descriptions

Table 4. Register 0 - PLL Configuration Register

Data Bit	Name	Description	Use
B15 (MSB)/DB13	Reserved	Reserved	Set bit to 0
B14/DB12	Reserved	Reserved	Set bit to 0
B13/DB11	V23PLL	Low Voltage PLL Regulator	0: PLL Regulator set to 2.7V 1: PLL Regulator set to 2.3V
B12/DB10	NODP	No Dither	0: 2nd order Fractional-N 1: 1st order Fractional-N
B11/DB9	RCLP	RSSI Clip Enable	0: RSSI hardware clipping 1: No RSSI clipping
B10/DB8	LVLO	Low Voltage Lockout	0: PAON unaffected by low voltage events 1: PAON gated by latched low voltage lockout
B9/DB7	TXOL	Transmit PLL Mode	0: Closed Loop in Transmit mode 1: Open Loop in Transmit mode
B8/DB6	TXM	TX RF Output Mode	0: TXO always on in Transmit mode 1: TXO follows PAON signal
B7/DB5	TPC	Transmit Power Control	0: AOUT pin pulled to ground 1: AOUT pin high impedance
B6/DB4	TXCW	Transmit Test Mode	0: FSK modulation in Transmit mode 1: CW in Transmit mode (no modulation)
B5/DB3	LOL	PLL IF Shift Configuration	0: -1.024MHz LO Shift in Receive 1: +1.024MHz LO shift in Receive
B4/DB2	AOUT	Analog Output	0: AOUT pin is Transmit Power Control 1: AOU Tpin is Analog Data Out
B3/DB1	RDO	Reference Frequency Select	0: 6.144MHz nominal reference frequency 1: 12.288MHz nominal reference frequency (preferred)
B2/DB0	QPP	PLL Charge Pump Polarity	0: $F_c < F_{ref}$; Charge pump sources current 1: $F_c < F_{ref}$; Charge pump sinks current
B1/ADR1	ADR1	MSB Address Bit	ADR1=0
B0 (LSB)/ADRO	ADRO	LSB Address Bit	ADRO=0

QPP

Charge Pump Polarity: This bit sets the charge pump polarity to sink or source current. For a majority of applications, this bit is cleared (QPP = 0). For applications where an external inverting amplifier is in the loop filter, this bit is set to 1 to change the charge pump polarity (see Table 5).

Table 5. PLL Charge Pump Polarity

QPP	PLL Charge Pump Polarity
0	For $F_c < F_{ref}$; Charge pump sources current

RDO

Reference Divider: This bit sets the reference divider from the FREF pin to the reference input of the PLL phase/frequency detector (see Table 6).

Table 6. Reference Frequency Select

RDO	Reference Division	Nominal Reference Frequency
0	1	6.144MHz
1	2	12.288MHz

AOUT

Analog Output Mode: This bit changes the function of the AOUT pin between an analog data output and transmit power control (see Table 7).

Table 7. AOUT PIN Function

AOUT	AOUT PIN Function
0	Transmit Power Control
1	Data Filter Analog Output

LOL

PLL IF Shift: This bit shifts the PLL by ± 1.024 MHz in Receive mode (see Table 8).

Table 8. PLL IF Shift Configuration

LOL	PLL IF Shift Configuration
0	-1.024 MHz LO Shift in Receive
1	+1.024 MHz LO Shift in Receive

TXCW

Transmit Continuous Wave: This bit produces a continuous wave (CW) transmitter output for product test when RXON is low (see Table 9).

Table 9. Transmit Modulation Mode

TXCW	Transmit Modulation
0	FSK Modulation
1	CW - No Modulation

TPC

Transmit Power Control: When the AOUT bit is low, this bit controls the state of the open-drain output pin. Although this bit can be changed at any time, the AOUT pin only changes state at the falling edge of RXON (see Table 10).

TPC	TPC PIN State
0	Pulled to Ground
1	High Impedance

TXM

Transmit Mode Bit: This bit controls the TX RF buffer state timing mode. It must be reset to 0 for normal operation (see Table 11).

Table 11. TXM Mode

TXM	TXO Buffer Behavior
0	RF Output Always On in TXMode
1	RF Output Follows PAON

TXOL

Transmit PLL Mode: This bit is provided for testing. It disables the PLL during transmit slots so that the analog modulation path onto the VCO can be tested without the digital path through the PLL (see Table 12).

Table 12. TXOL Operation

TXOL	Transmit PLL Mode
0	Closed loop in TX mode
1	Open loop in TX mode

LVLO

Low Voltage Lock Out: The LVLO bit enables a transmit low voltage lockout latch which shuts off the transmitter by de-asserting the PAON output. This latch is set if the supply voltage drops below 2.65V and is reset when RXON goes high (see Table 13).

Table 13. LVLO Operation

LVLO	PAON Behavior
0	PAON Undisturbed
1	PAON de-asserted when VCCA < 2.65V, Reset by RXON high

RCLP

RSSI Clip Enable: The RCLP bit disables the RSSI clipping circuitry. With RCLP low, the RSSI output voltage is clipped at 1.95V (see Table 14).

RCLP Operation

RCLP	RSSI Behavior
0	RSSI output clipped
1	RSSI output not clipped

NODP

PLL Dithering: This bit removes 2nd order dither from the fractional-N PLL when high, reducing the PLL to a 1st order fractional-N (see Table 15).

Table 15. Dithering Operation

NODP	PLL Behavior
0	2nd order Fractional-N PLL
1	1st order Fractional-N PLL

V23PLL

Voltage on PLL Regulator: This bit controls the voltage of the PLL regulator. It is set to 0 for normal operation. (see Table 16).

Table 16. V23PLL Mode

V23PLL	Regulation Behavior
0	PLL Regulator set to 2.7V
1	PLL Regulator set to 2.3V

Register 1 Bit Descriptions

Table 17. Register 1 - Channel Frequency Register

Data Bit	Name	Description	Use
B15 (MSB)/DB13	N9	PLL Integer Part - N	N=MOD [Floor ((F/4.608) - 0.512 - ((P+11)/18)), 1024]
B14/DB12	N8		
B13/DB11	N7		
B12/DB10	N6		
B11/DB9	N5		
B10/DB8	N4		
B9/DB7	N3		
B8/DB6	N2		
B7/DB5	N1		
B6/DB4	N0		
B5/DB3	P3	PLL Fractional Part - P	P=MOD [Round (F/0.512 - 11), 9]
B4/DB2	P2		
B3/DB1	P1		
B2/DB0	P0		
B1/ADR1	ADR1	MSB Address Bit	ADR1=0
B0 (LSB)/ADRO	ADRO	LSB Address Bit	ADRO=0

This register sets the channel frequency for the ML5800 transceiver.

The “N” Field is the 10-bit integer part of the division ratio, modulo 1024. There is an implicit MSB in the “B16” position which is fixed to “1”. Values from 0 (00 0000 0000b) to 1022 (11 1111 1110b) are all valid and correspond to N =1024 to N = 2046. The 4-bit “P” field is the fractional part of the division ratio, modulo 9. Values from 0 (0000b) to 8 (1000b) are valid.

The relationship between N and P with a given channel frequency F is:

$$F = 1.5 * 6.144 * (512 + N/2 + (P+11)/18) \text{ MHz}$$

To calculate N and P from the channel frequency, F (in MHz) use these formulae:

$$N = \text{MOD} [\text{Floor} ((F/4.608) - 0.512 - ((P+11)/18)), 1024]$$

$$P = \text{MOD} [\text{Round} (F/0.512 - 11), 9]$$

Register 2 Bit Descriptions

Table 18. Register 2 - Test Mode Access Register

Data Bit	Name	Description	Use
B15 (MSB)/DB13	TMODE	Filter Alignment Control Bits	See Table 21
B14/DB12	CFB6		
B13/DB11	CFB5		
B12/DB10	CFB4		
B11/DB9	CFB3		
B10/DB8	CFB2		
B9/DB7	CFB1		
B8/DB6	CFB0		
B7/DB5	DTM2	Digital Test Control Bits PLL Fractional Part - P	See Table 20 P=MOD [Round (F/0.512 - 11), 9]
B6/DB4	DTM1		
B5/DB3	DTM0		
B4/DB2	ATM2	Analog Test Control Bits	See Table 19
B3/DB1	ATM1		
B2/DB0	ATM0		
B1/ADR1	ADR1	MSB Address Bit	ADR1=0
B0 (LSB)/ADRO	ADRO	LSB Address Bit	ADRO=0

ATM<2:0>

Analog Test Control Bits: The performance of the ML5800 is not specified in these test modes. Although primarily intended for IC test and debug, they also can help in debugging the radio system. The default (power-up) state of these bits is ATM<2:0> = <0,0,0>. When a non-zero value is written to the field, the RSSI and AOUT_TPC pins become analog test access ports, giving access to the outputs of key signal processing stages in the transceiver. During normal operation, the ATM field must be set to zero (see Table 19).

Table 19. Analog Test Control Bits

ATM2	ATM1	ATM0	RSSI	AOUT
0	0	0	RSSI	Set AOUT bit
0	0	1	Data Filter input +	Data Filter input -
0	1	0	I IF Filter Output	Q IF Filter Output
0	1	1	Q IF Filter - input	Q IF Filter + input
1	0	0	I IF Filter - input	I IF Filter + input
1	0	1	Data Filter + Output	Data Filter - Output
1	1	0	I IF Limiter Output	Q IF Limiter Output
1	1	1	1.67V Voltage Reference	VCO Modulation Port Input

DTM <2:0>

Digital Test Control Bits: The performance of the ML5800 is not specified in these test modes. Although primarily intended for IC test and debug, they also can help in debugging the radio system. The default (power up) state of these bits is DTM<2:0> = <0,0,0>. When a non-zero value is written to these fields, the DOUT and PAON pins become a digital test access port for key digital signals in the transceiver. During normal operation, the DTM field must be set to zero (see Table 20).

Table 20: Digital Test Control Bits

DTM2	DTM1	DTM0	PAON	DOUT
0	0	0	PA Control	Data Out
0	0	1	No output	AGC Switch State
0	1	0	Prescaler Out Divide 64	PLL Main Divider Output
0	1	1	No Output	PLL Reference Divider Output
1	0	0	PLL 2nd Carry Diagnostic o/p	PLL 1st Carry Diagnostic o/p
1	0	1	No Output	TCAL (Cal. Timer)
1	1	0	3MHz from PLL	LOCKN
1	1	1	No Out out	UDLATCH

TMODE and CFB <6:0>

The TMODE bit disables the automatic filter alignment circuitry, and then the CFB field directly tunes the filter. The CFB field is a 7 bit binary value that tunes the IF and data filters. The correct value for CFB6 to CFB0 varies depending upon absolute values of the integrated resistors and capacitors on the chip. The IF filter center frequency, IF filter bandwidth, data filter bandwidth and F to V converter center frequency are all tuned together by the CFB field (see Table 21).

Table 21. TMODE and CFB <6:0> Filter Alignment Test Bits

TMODE	Filter Alignment Mode
0	Filters auto aligned during receive slots
1	Filters tuned by CFB <6:0> value

NOT FOR REUSE DESIGN

Physical Dimensions

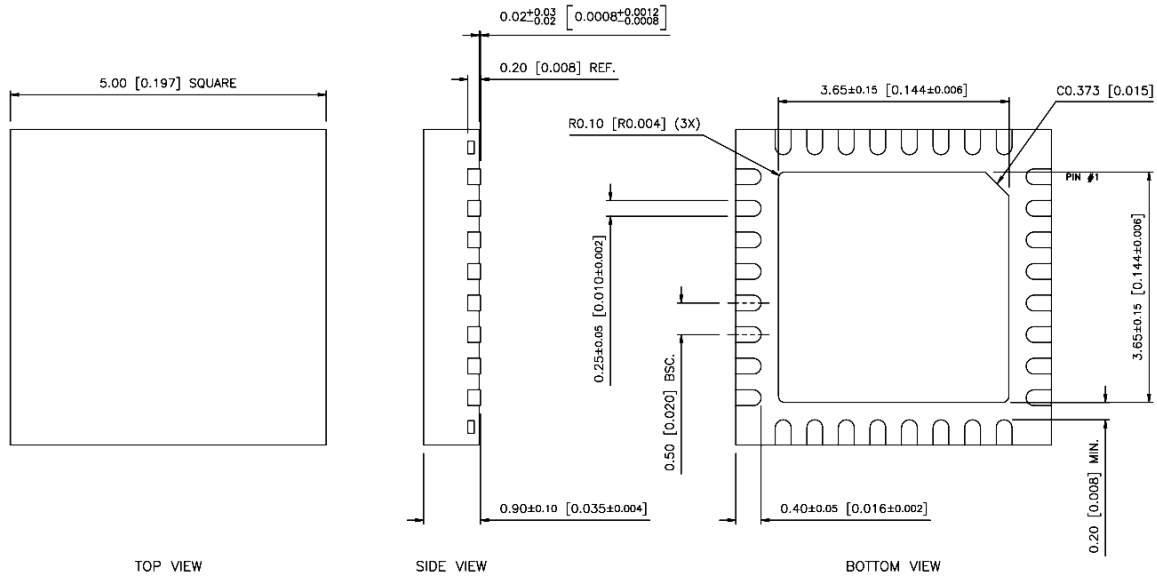

Figure6: 32-Leadless Plastic Chip Carrier (QFN) Dimensions

Notes:

- 1.) All dimensions are in millimeters (mm) or [Inches]
- 2.) General tolerances: ± 0.05 [± 0.002]
- 3.) This package meets “Green” Pb-Free requirements and is compliant with the European Union directives WEEE (Waste Electrical and Electronic Equipment) and RoHS (Restriction of the use of certain Hazardous Substances in electrical and electronic equipment). The package pins are finished with 100% matte tin.

Ordering Information

Part Number	Description (QTY)
ML5800DM-SB	ML5800DM-SB (5 pc.)
ML5800DM-SQ	Short reel ML5800DM-SQ (25 pc.)
ML5800DM-SR	5.8GHz IF Digital Transcv Trans (100 pc.)
ML5800DM-T	5.8GHz IF Digital Transceiver (2500 pc.)
ML5800SK-02	ML5800 Starter Kit, 8051 uP version (1 kit)
ML5800SK-03	ML5800 Starter Kit, XlnC2 uP version (1 kit)