



3
GENERAL PURPOSE
AMPLIFIERS (LNAs,
HPAs, LINEAR AMPS)

Features

- Reliable, Low-Cost HBT Design
- 15.5 dB Gain, +12.0 dBm P1dB@2GHz
- High P1dB of +14.6 dBm@6.0GHz
- Single Power Supply Operation
- 50Ω I/O Matched for High Freq. Use

Applications

- Narrow and Broadband Commercial and Military Radio Designs
- Linear and Saturated Amplifiers
- Gain Stage or Driver Amplifiers for MWRadio/Optical Designs (PTP/PMP/LMDS/UNII/VSAT/WLAN/Cellular/DWDM)

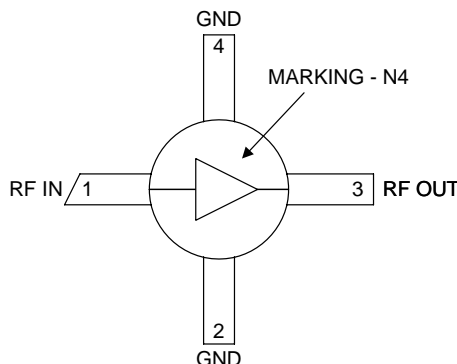

Functional Block Diagram

Product Description

The NLB-400 cascadable broadband InGaP/GaAs MMIC amplifier is a low-cost, high-performance solution for general purpose RF and microwave amplification needs. This 50Ω gain block is based on a reliable HBT proprietary MMIC design, providing unsurpassed performance for small-signal applications. Designed with an external bias resistor, the NLB-400 provides flexibility and stability. The NLB-400 is packaged in a low-cost, surface-mount plastic package, providing ease of assembly for high-volume tape-and-reel requirements.

Ordering Information

NLB-400	Cascadable Broadband GaAs MMIC Amplifier DC to 6GHz
NLB-400-T1	Tape & Reel, 1000 Pieces
NLB-400-E	Fully Assembled Evaluation Board
NBB-X-K1	Extended Frequency InGaP Amp Designer's Tool Kit

Optimum Technology Matching® Applied

- | | | | |
|-----------------------------------------------|--------------------------------------|-------------------------------------|-----------------------------------|
| <input type="checkbox"/> GaAs HBT | <input type="checkbox"/> SiGe BiCMOS | <input type="checkbox"/> GaAs pHEMT | <input type="checkbox"/> GaN HEMT |
| <input type="checkbox"/> GaAs MESFET | <input type="checkbox"/> Si BiCMOS | <input type="checkbox"/> Si CMOS | |
| <input checked="" type="checkbox"/> InGaP HBT | <input type="checkbox"/> SiGe HBT | <input type="checkbox"/> Si BJT | |

RF MICRO DEVICES®, RFMD®, Optimum Technology Matching®, Enabling Wireless Connectivity™, PowerStar®, POLARIS™ TOTAL RADIO™ and UltimateBlue™ are trademarks of RFMD, LLC. BLUETOOTH is a trademark owned by Bluetooth SIG, Inc., U.S.A. and licensed for use by RFMD. All other trade names, trademarks and registered trademarks are the property of their respective owners. ©2006, RF Micro Devices, Inc.

3
GENERAL PURPOSE
AMPLIFIERS (LNAs,
HPAs, LINEAR AMPS)

Absolute Maximum Ratings

Parameter	Rating	Unit
RF Input Power	+20	dBm
Power Dissipation	300	mW
Device Current	70	mA
Channel Temperature	200	°C
Operating Temperature	-45 to +85	°C
Storage Temperature	-65 to +150	°C

Exceeding any one or a combination of these limits may cause permanent damage.



Caution! ESD sensitive device.

The information in this publication is believed to be accurate and reliable. However, no responsibility is assumed by RF Micro Devices, Inc. ("RFMD") for its use, nor for any infringement of patents, or other rights of third parties, resulting from its use. No license is granted by implication or otherwise under any patent or patent rights of RFMD. RFMD reserves the right to change component circuitry, recommended application circuitry and specifications at any time without prior notice.

RoHS status based on EUDirective2002/95/EC (at time of this document revision).

Parameter	Specification			Unit	Condition
	Min.	Typ.	Max.		
Overall					$V_D = +3.9V, I_{CC} = 47mA, Z_0 = 50\Omega, T_A = +25^\circ C$
Small Signal Power Gain, S21	16.0	17.0		dB	f=0.1GHz to 1.0GHz
		13.0		dB	f=1.0GHz to 4.0GHz
	10.8	11.5		dB	f=4.0GHz to 6.0GHz
Gain Flatness, GF		±0.65		dB	f=0.1GHz to 2.0GHz
Input VSWR		1.65:1			f=0.1GHz to 4.0GHz
		1.65:1			f=4.0GHz to 6.0GHz
		1.75:1			f=6.0GHz to 10.0GHz
Output VSWR		1.5:1			f=0.1GHz to 4.0GHz
		1.9:1			f=4.0GHz to 6.0GHz
		2.2:1			f=6.0GHz to 10.0GHz
Bandwidth, BW		4.7		GHz	BW3 (3 dB)
Output Power @ -1dB Compression, P1dB		12.0		dBm	f=2.0GHz
		14.6		dBm	f=6.0GHz
Noise Figure, NF		4.1		dB	f=3.0GHz
Third Order Intercept, IP3		+29.6		dBm	f=2.0GHz
		+27.3			f=6.0GHz
Reverse Isolation, S12		-18		dB	f=0.1GHz to 12.0GHz
Device Voltage, V_D	3.6	3.9	4.2	V	
Gain Temperature Coefficient, $\delta G_T / \delta T$		-0.0015		dB/°C	
MTTF versus Temperature @ $I_{CC} = 50mA$					
Case Temperature		85		°C	
Junction Temperature		119		°C	
MTTF		>1,000,000		hours	
Thermal Resistance					
θ_{JC}		185		°C/W	$\frac{J_T - T_{CASE}}{V_D \cdot I_{CC}} = \theta_{JC} (^\circ C / Watt)$

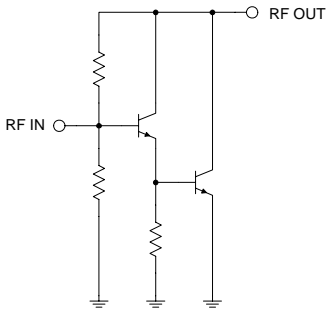
Pin	Function	Description	Interface Schematic
1	RF IN	RF input pin. This pin is NOT internally DC blocked. A DC blocking capacitor, suitable for the frequency of operation, should be used in most applications. DC coupling of the input is not allowed, because this will override the internal feedback loop and cause temperature instability.	
2	GND	Ground connection. For best performance, keep traces physically short and connect immediately to ground plane.	
3	RF OUT	RF output and bias pin. Biasing is accomplished with an external series resistor and choke inductor to V_{CC} . The resistor is selected to set the DC current into this pin to a desired level. The resistor value is determined by the following equation: $R = \frac{(V_{CC} - V_{DEVICE})}{I_{CC}}$ Care should also be taken in the resistor selection to ensure that the current into the part never exceeds maximum datasheet operating current over the planned operating temperature. This means that a resistor between the supply and this pin is always required, even if a supply near 5.0V is available, to provide DC feedback to prevent thermal runaway. Because DC is present on this pin, a DC blocking capacitor, suitable for the frequency of operation, should be used in most applications. The supply side of the bias network should also be well bypassed.	
4	GND	Same as pin 2.	

Package Drawing

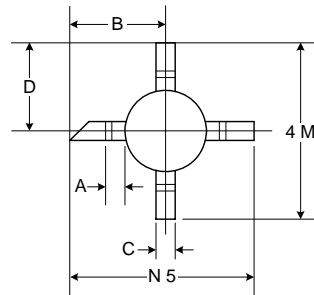

Symbol	MILLIMETERS			INCHES		
	Min.	Nom.	Max.	Min.	Nom.	Max.
A	0.535 REF.			0.021 REF.		
B	2.39	2.54	2.69	0.094	0.100	0.106
C	0.436	0.510	0.586	0.017	0.020	0.023
D	2.19	2.34	2.49	0.086	0.092	0.098
E	1.91	2.16	2.41	0.075	0.085	0.095
F	1.32	1.52	1.72	0.052	0.060	0.068
G	0.10	0.15	0.20	0.004	0.006	0.008
H	0.535	0.660	0.785	0.021	0.026	0.031
1 J	0.05	0.10	0.15	0.002	0.004	0.006
2 K	0.65	0.75	0.85	0.025	0.029	0.033
3 L	0.85	0.95	1.05	0.033	0.037	0.041
4 M	4.53	4.68	4.83	0.178	0.184	0.190
5 N	4.73	4.88	5.03	0.186	0.192	0.198

NOTE: All dimensions are in millimeters, and the dimensions in inches are for reference only.

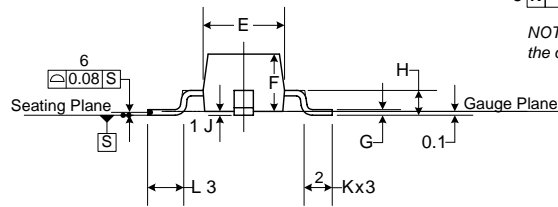

Typical Bias Configuration

Application notes related to biasing circuit, device footprint, and thermal considerations are available on request.

3
 GENERAL PURPOSE
 AMPLIFIERS (LNAs,
 HPAs, LINEAR AMPS)

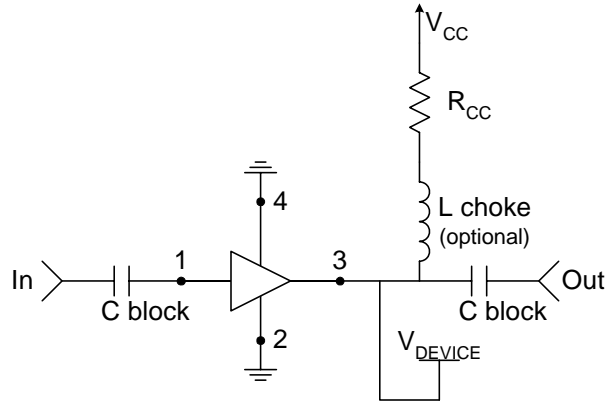

Recommended Bias Resistor Values						
Supply Voltage, V_{CC} (V)	5	8	10	12	15	20
Bias Resistor, R_{CC} (Ω)	23	87	129	172	236	343

**Extended Frequency InGaP Amplifier Designer's Tool Kit
NBB-X-K1**

This tool kit was created to assist in the design-in of the RFMD NBB- and NLB-series InGaP HBT gain block amplifiers. Each tool kit contains the following.

- 5 each NBB-300, NBB-310 and NBB-400 Ceramic Micro-X Amplifiers
- 5 each NLB-300, NLB-310 and NLB-400 Plastic Micro-X Amplifiers
- 2 Broadband Evaluation Boards and High Frequency SMA Connectors
- Broadband Bias Instructions and Specification Summary Index for ease of operation

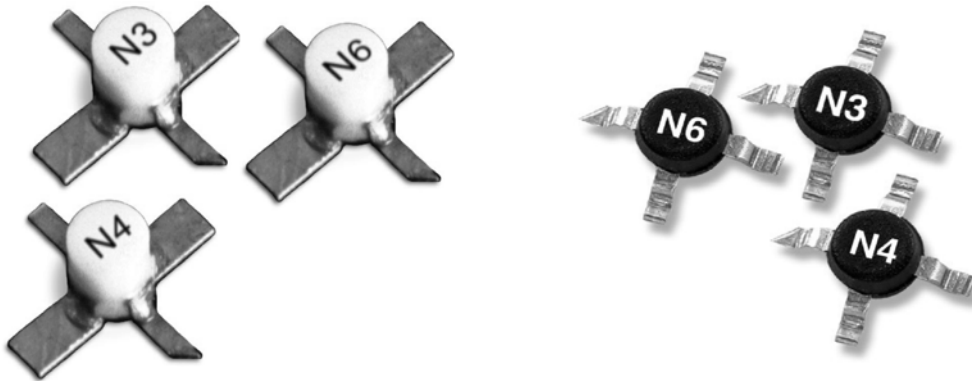

Tape and Reel Dimensions

All Dimensions in Millimeters

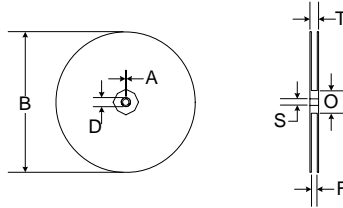

14.732 mm (7") REEL			Plastic, Micro-X	
	ITEMS	SYMBOL	SIZE (mm)	SIZE (inches)
FLANGE	Diameter	B	178 +0.25/-4.0	7.0 +0.079/-0.158
	Thickness	T	18.4 MAX	0.724 MAX
	Space Between Flange	F	12.8 +2.0	0.50 +0.08
HUB	Outer Diameter	O	76.2 REF	3.0 REF
	Spindle Hole Diameter	S	13.716 +0.5/-0.2	0.540 +0.020/-0.008
	Key Slit Width	A	1.5 MIN	0.059 MIN
	Key Slit Diameter	D	20.2 MIN	0.795 MIN

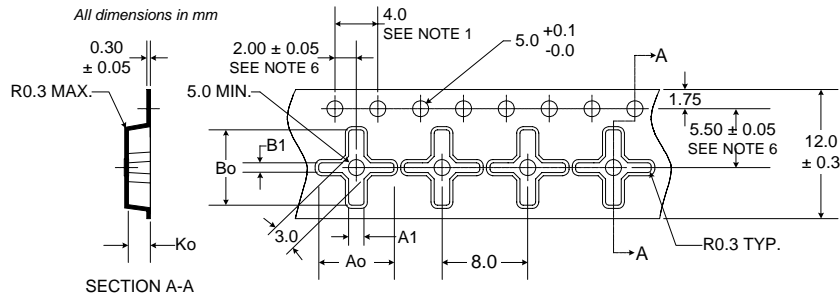
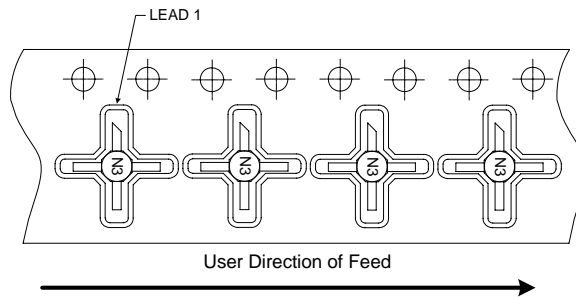

NOTES:

1. 10 sprocket hole pitch cumulative tolerance ± 0.2 .
2. Camber not to exceed 1 mm in 100 mm.
3. Material: PS+C.
4. A_o and B_o measured on a plane 0.3 mm above the bottom of the pocket.
5. K_o measured from a plane on the inside bottom of the pocket to the surface of the carrier.
6. Pocket position relative to sprocket hole measured as true position of pocket, not pocket hole.

$A_o = 7.0$ MM
 $A_1 = 1.8$ MM
 $B_o = 7.0$ MM
 $B_1 = 1.3$ MM
 $K_o = 2.1$ MM

3
 GENERAL PURPOSE
 AMPLIFIERS (LNAs,
 HPAs, LINEAR AMPs)

S11 versus Frequency, Over Temperature

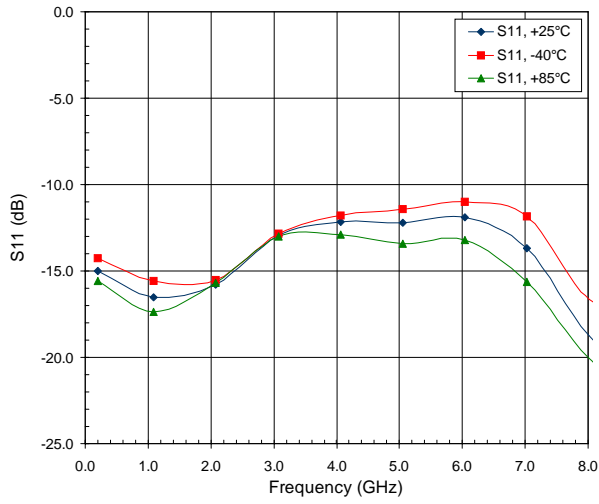

S21 versus Frequency, Over Temperature

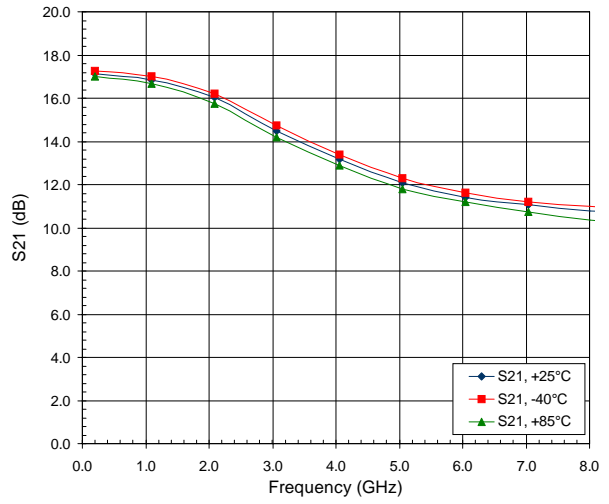

S12 versus Frequency, Over Temperature

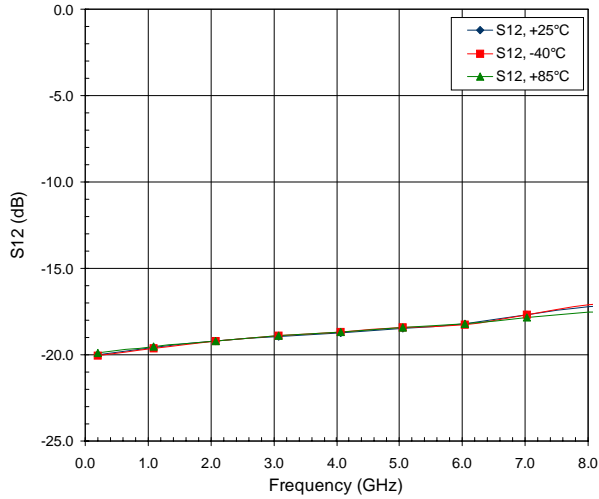

S22 versus Frequency, Over Temperature

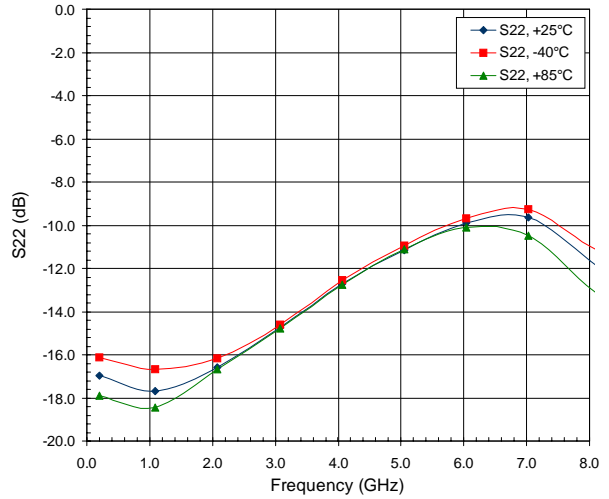

Output P1dB versus Frequency Across Temperature

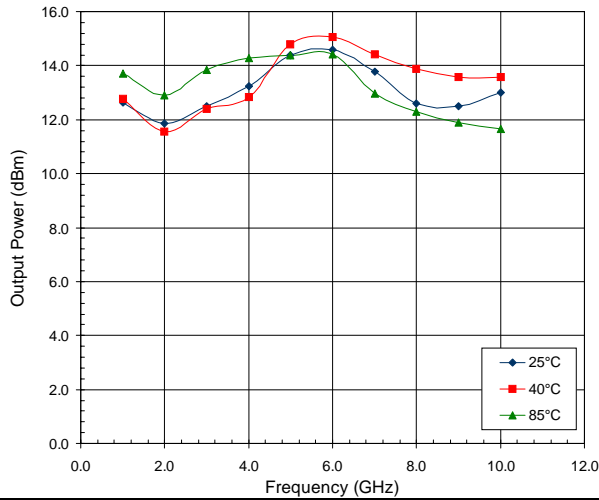

Noise Figure versus Frequency at +25°C

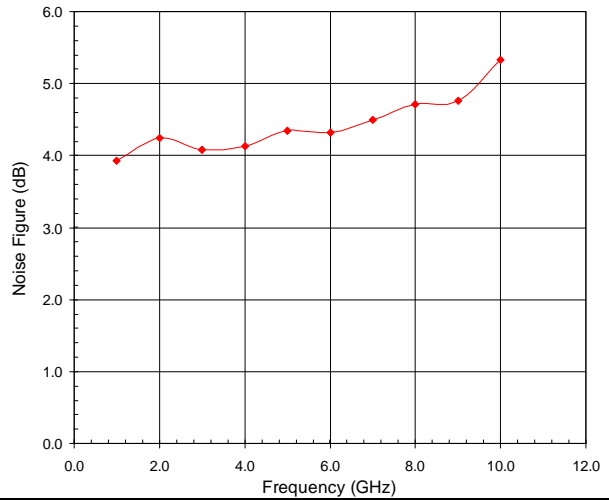

Note: The s-parameter gain results shown include device performance as well as evaluation board and connector loss variations. The insertion losses of the evaluation board and connectors are as follows:

- 1GHz to 4GHz=-0.06dB
- 5GHz to 9GHz=-0.22dB
- 10GHz to 14GHz=-0.50dB
- 15GHz to 20GHz=-1.08dB

3
GENERAL PURPOSE
AMPLIFIERS (LNAs,
HPAs, LINEAR AMPs)

RoHS* Banned Material Content

RoHS Compliant: Yes
 Package total weight in grams (g): 0.024
 Compliance Date Code: 0602
 Bill of Materials Revision: -
 Pb Free Category: e3

Bill of Materials	Parts Per Million (PPM)					
	Pb	Cd	Hg	Cr VI	PBB	PBDE
Die	0	0	0	0	0	0
Molding Compound	0	0	0	0	0	0
Lead Frame	0	0	0	0	0	0
Die Attach Epoxy	0	0	0	0	0	0
Wire	0	0	0	0	0	0
Solder Plating	0	0	0	0	0	0

This RoHS banned material content declaration was prepared solely on information, including analytical data, provided to RFMD by its suppliers, and applies to the Bill of Materials (BOM) revision noted

* DIRECTIVE 2002/95/EC OF THE EUROPEAN PARLIAMENT AND OF THE COUNCIL of 27 January 2003 on the restriction of the use of certain hazardous substances in electrical and electronic equipment