



Features

- Multiple Frequency Outputs
 - Fo: 7.80GHz to 8.80GHz
 - Fo/2: 3.90GHz to 4.40GHz
 - Fo/4: 1.95GHz to 2.20GHz
- No External Resonator Required
- Integrated Frequency Divider
- Phase Noise: -115dBc/Hz at 100kHz Offset
- Flat Output Power Over Frequency Tuning Range 1.5V to 14.5V
 - Fo: 9dBm
 - Fo/2: 5dBm
 - Fo/4: -2dBm
- Low Power Consumption
 - 5V/240mA (Divider On)
 - 5V/180mA (Divider Off)
- 32-Lead 5mmx5mm Plastic Overmolded QFN

Applications

- Point-to-Point Radio
- Point-to-Multipoint Radio
- Satellite Communications
- Test Equipment
- Military
- Aerospace

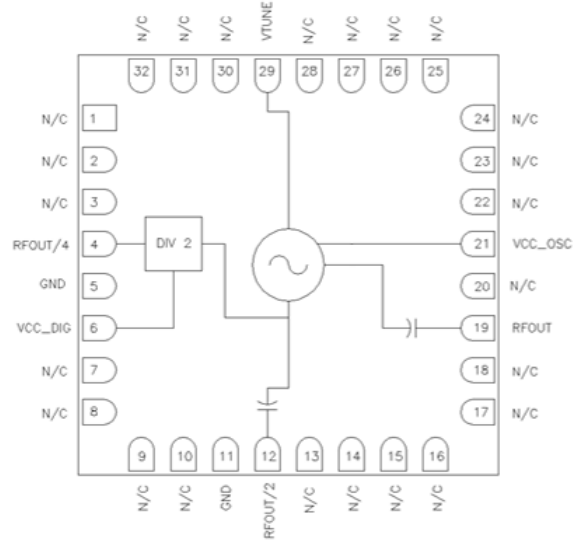

Functional Block Diagram

Product Description

RFMD's RFVC1832 is a 5V InGaP MMIC VCO with an integrated frequency divider providing additional Fo/2 and Fo/4 outputs. With an Fo frequency range of 7.8GHz to 8.8GHz its monolithic structure provides excellent temperature, shock, and vibration performance. Output power (Fo) is +9dBm and is flat across the tuning voltage range of 1.5V to 14.5V. Phase noise is typically -115dBc/Hz at 100kHz offset. The device operates from a low supply current of 240mA which can be further reduced to 180mA by disabling the divider functions if not required. The RFVC1832 is available in a low cost 5mmx5mm surface mount plastic overmolded QFN outline.

Ordering Information

RFVC1832S2	Sample bag with 2 pieces
RFVC1832SB	Sample bag with 5 pieces
RFVC1832SQ	Bag with 25 pieces
RFVC1832SR	Bag with 100 pieces
RFVC1832TR7	7" Reel with 750 pieces
RFVC1832PCBA-410	Evaluation Board

Optimum Technology Matching® Applied

- | | | | |
|-----------------------------------------------|--------------------------------------|-------------------------------------|------------------------------------|
| <input type="checkbox"/> GaAs HBT | <input type="checkbox"/> SiGe BiCMOS | <input type="checkbox"/> GaAs pHEMT | <input type="checkbox"/> GaN HEMT |
| <input type="checkbox"/> GaAs MESFET | <input type="checkbox"/> Si BiCMOS | <input type="checkbox"/> Si CMOS | <input type="checkbox"/> BiFET HBT |
| <input checked="" type="checkbox"/> InGaP HBT | <input type="checkbox"/> SiGe HBT | <input type="checkbox"/> Si BJT | <input type="checkbox"/> LD MOS |

RF MICRO DEVICES®, RFMD®, Optimum Technology Matching®, Enabling Wireless Connectivity™, PowerStar®, POLARIS™ TOTAL RADIO™ and UltimateBlue™ are trademarks of RFMD, LLC. BLUETOOTH is a trademark owned by Bluetooth SIG, Inc., U.S.A. and licensed for use by RFMD. All other trade names, trademarks and registered trademarks are the property of their respective owners. ©2006, RF Micro Devices, Inc.

Absolute Maximum Ratings

Parameter	Rating	Unit
V_{CC_OSC}, V_{CC_DIG}	+5.5	V
V_{TUNE}	0 to +15	V
Junction Temperature (T_J)	135	°C
Continuous P_{DISS} ($T_A = 85\text{ °C}$) (derate 37mW/°C above $T_A = 85\text{ °C}$)	1.65	W
Junction to Case, Thermal Resistance ($R_{\theta(j-a)}$)	30	°C/W
Storage Temperature	-65 to +150	°C
Operating Temperature	-40 to +85	°C
ESD Sensitivity (HBM)	Class 1A	



Caution! ESD sensitive device.

Exceeding any one or a combination of the Absolute Maximum Rating conditions may cause permanent damage to the device. Extended application of Absolute Maximum Rating conditions to the device may reduce device reliability. Specified typical performance or functional operation of the device under Absolute Maximum Rating conditions is not implied.

The information in this publication is believed to be accurate and reliable. However, no responsibility is assumed by RF Micro Devices, Inc. ("RFMD") for its use, nor for any infringement of patents, or other rights of third parties, resulting from its use. No license is granted by implication or otherwise under any patent or patent rights of RFMD. RFMD reserves the right to change component circuitry, recommended application circuitry and specifications at any time without prior notice.



RFMD Green: RoHS compliant per EU Directive 2002/95/EC, halogen free per IEC 61249-2-21, < 1000ppm each of antimony trioxide in polymeric materials and red phosphorus as a flame retardant, and <2% antimony in solder.

Parameter	Specification			Unit	Condition
	Min.	Typ.	Max.		
Electrical Specifications					$V_{CC} = 5V, T_A = +25\text{ °C}$
Operating Frequency					
F_o	7.80		8.80	GHz	
$F_o/2$	3.90		4.40	GHz	
$F_o/4$	1.95		2.20	GHz	
Output Power					
F_o		9		dBm	
$F_o/2$		5		dBm	
$F_o/4$		-2		dBm	
SSB Phase Noise					
10kHz offset at RF_{OUT}		-90		dBc/Hz	$V_{TUNE} = 5V$
100kHz offset at RF_{OUT}		-115		dBc/Hz	$V_{TUNE} = 5V$
Tune Voltage	1.5		14.5	V	
Supply Voltage (Oscillator and Divider)		5		V	
Supply Current					
V_{CC_OSC}		180		mA	
V_{CC_DIG}		60		mA	
Tune Port Leakage Current		10		μA	
Output Return Loss		6		dB	
Harmonics/Sub-harmonics					Measured with RF probes at package, not at SMA connections on EVB
1/2		45		dBc	
3/2		45		dBc	
2 nd		15		dBc	
3 rd		25		dBc	
Pulling (into a 2.0:1 VSWR)		5		MHz pp	
Pushing		21		MHz/V	
Frequency Drift Rate		0.8		MHz/°C	

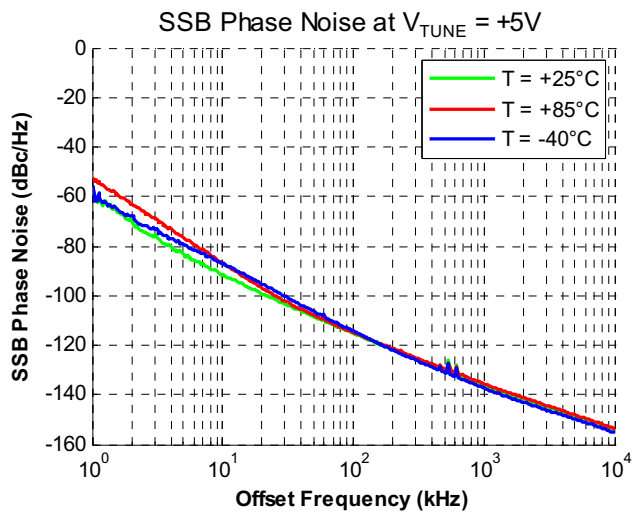
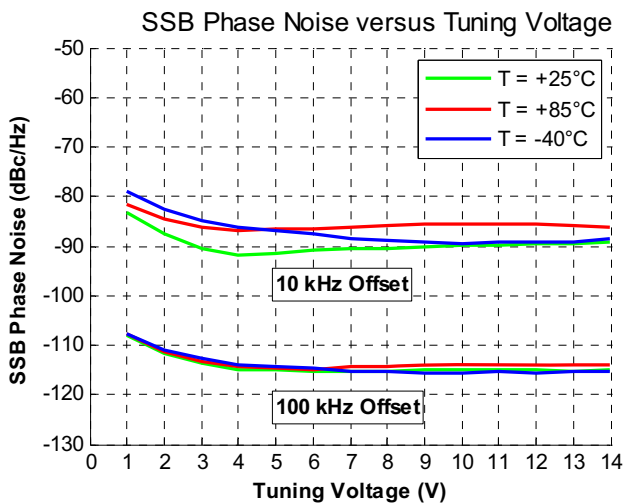
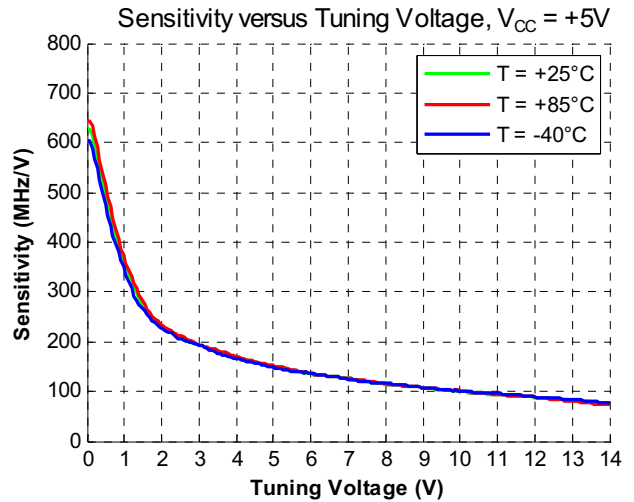
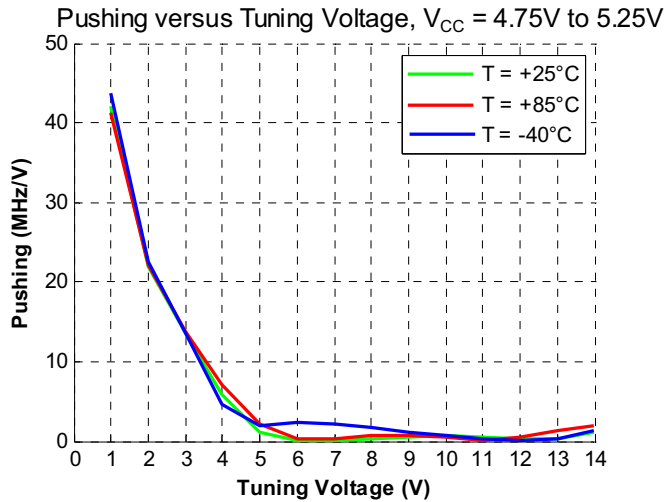
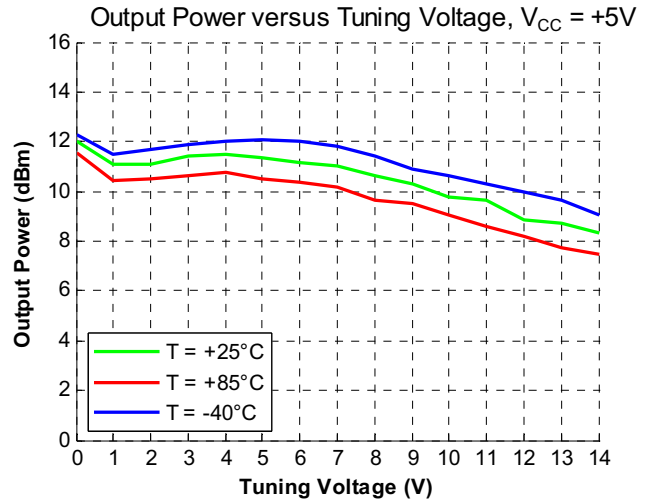
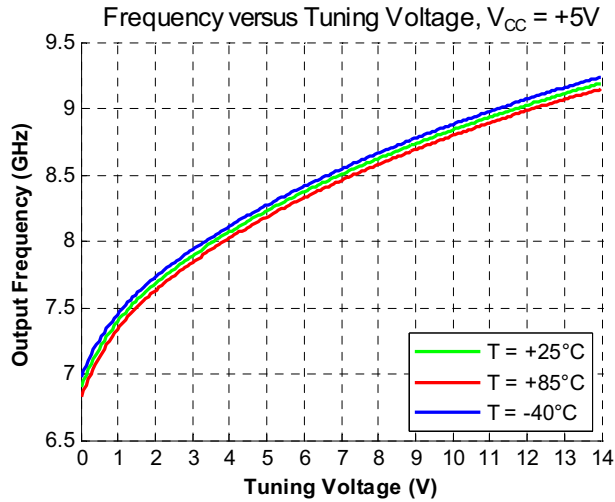

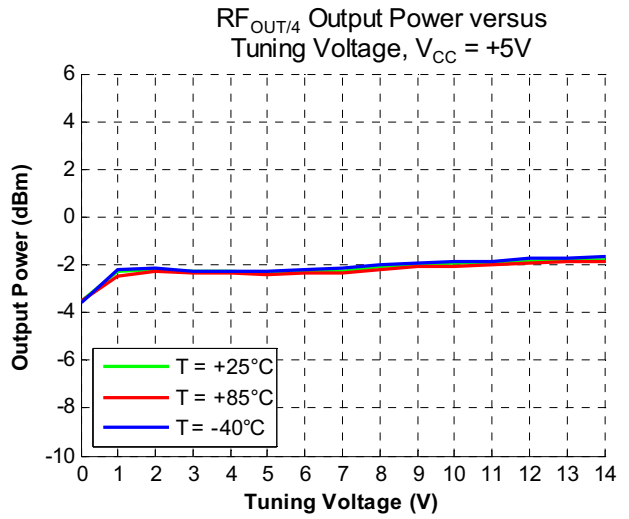
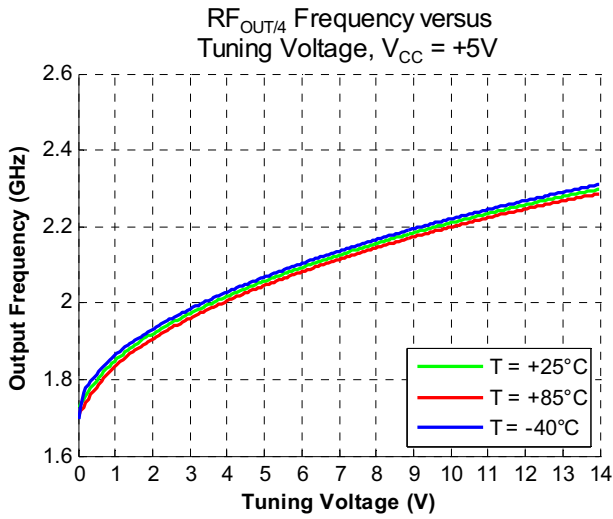
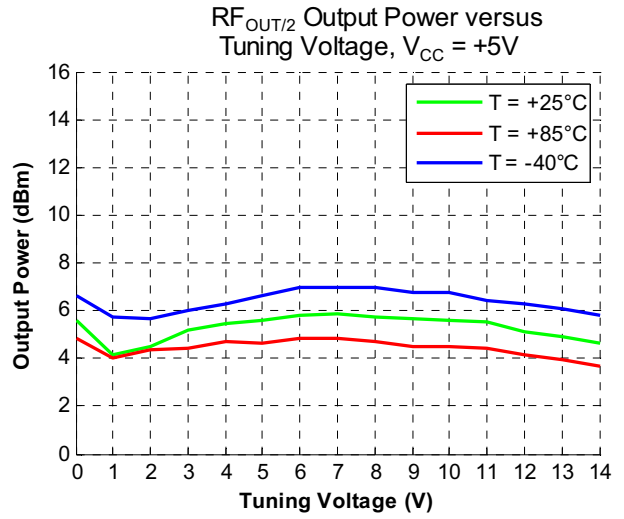
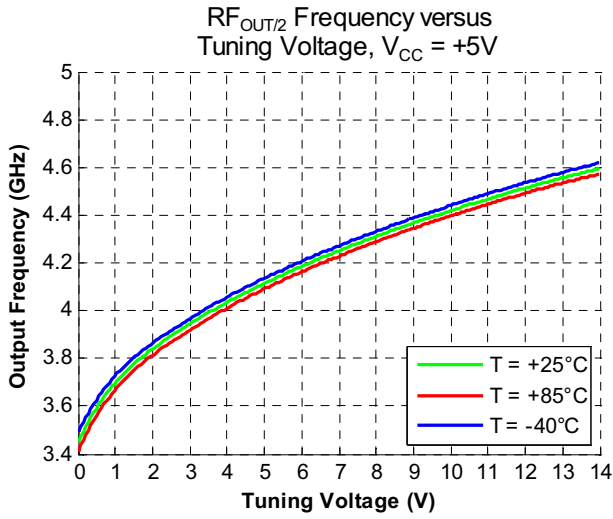

Pin Names and Description

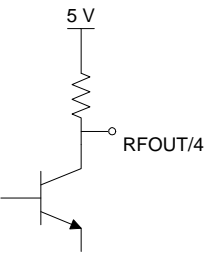
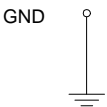
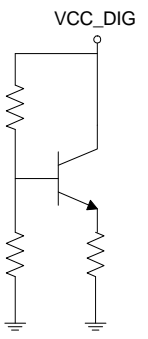
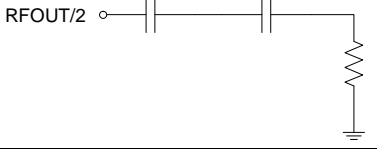
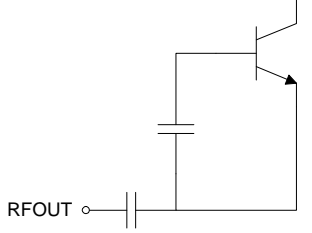
Pin	Function	Description	Interface Schematic
1-3,7-10, 13-18, 20, 22-28,30-32	N/C	No internal connection.	
4	RFOUT/4	VCO RF output at $F_o/4$. Externally DC-blocked.	
5,11,Package Base	GND	Connect to PCB ground.	
6	VCC_DIG	Supply voltage input for the integrated frequency divider. Typical +5V. Ground this pin to disable digital divider and reduce current consumption by 60mA.	
12	RFOUT/2	VCO RF output at $F_o/2$. Internally DC-blocked.	
19	RFOUT	VCO RF output at F_o . Internally DC-blocked.	

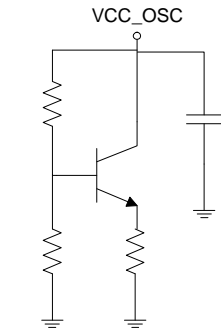
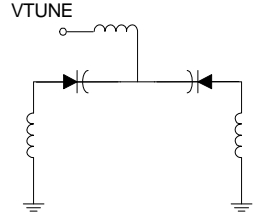
21	VCC_OSC	Supply voltage input for the VCO. Typical +5V.	
29	VTUNE	VCO control voltage input.	

Package Drawing (all dimensions are in mm)

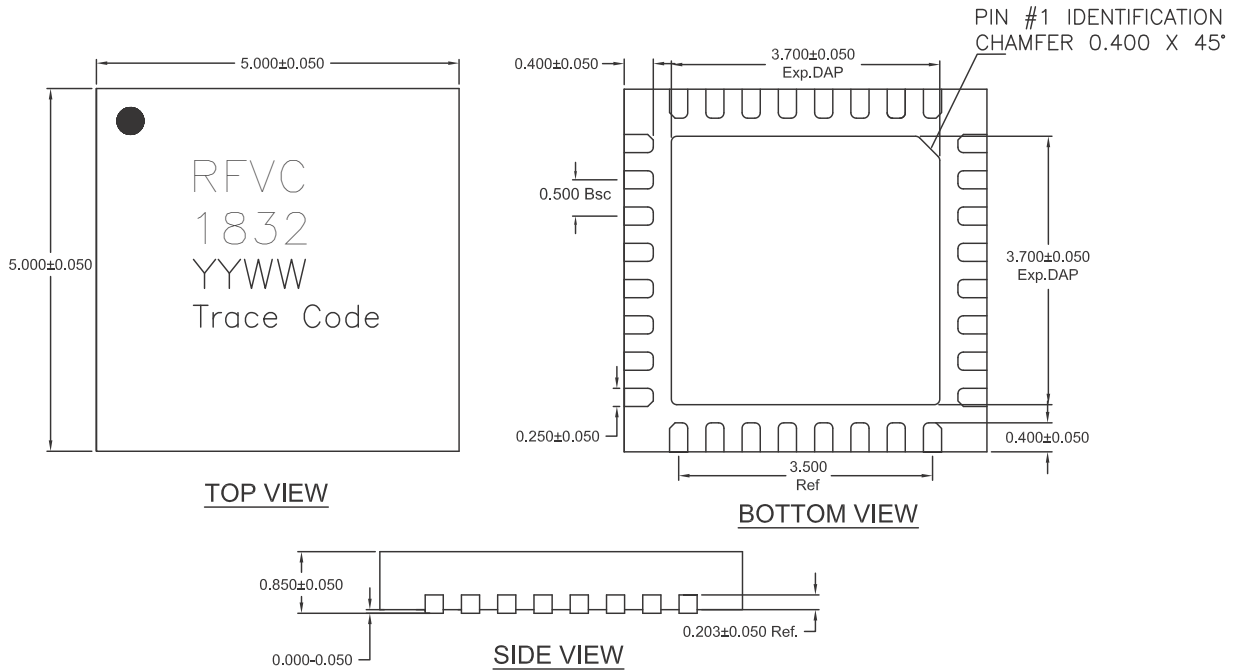

Notes:

1. Dimensions are for reference only.
2. Package body material: Plastic.
3. Lead and paddle plating: 8µm minimum of Sn over Cu leadframe.

Recommended PCB Layout

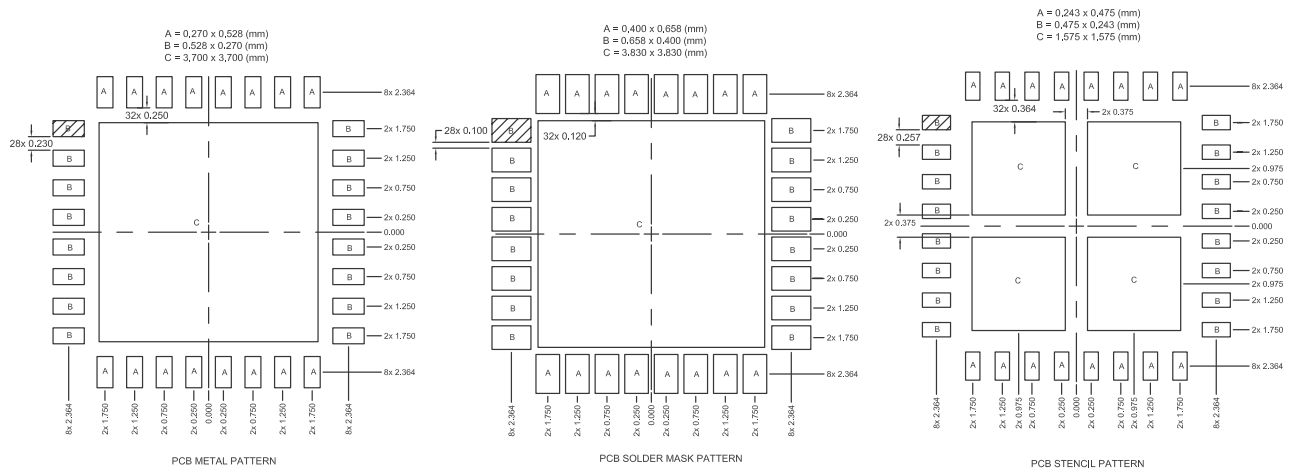

Thermal vias for center slug "C" should be incorporated into the PCB design. The number and size of thermal vias will depend on the application, the power dissipation, and the electrical requirements. Example of the number and size of vias can be found on the RFMD evaluation board layout.

Shaded are represents Pin 1 location.

Sample Application Circuit Schematic

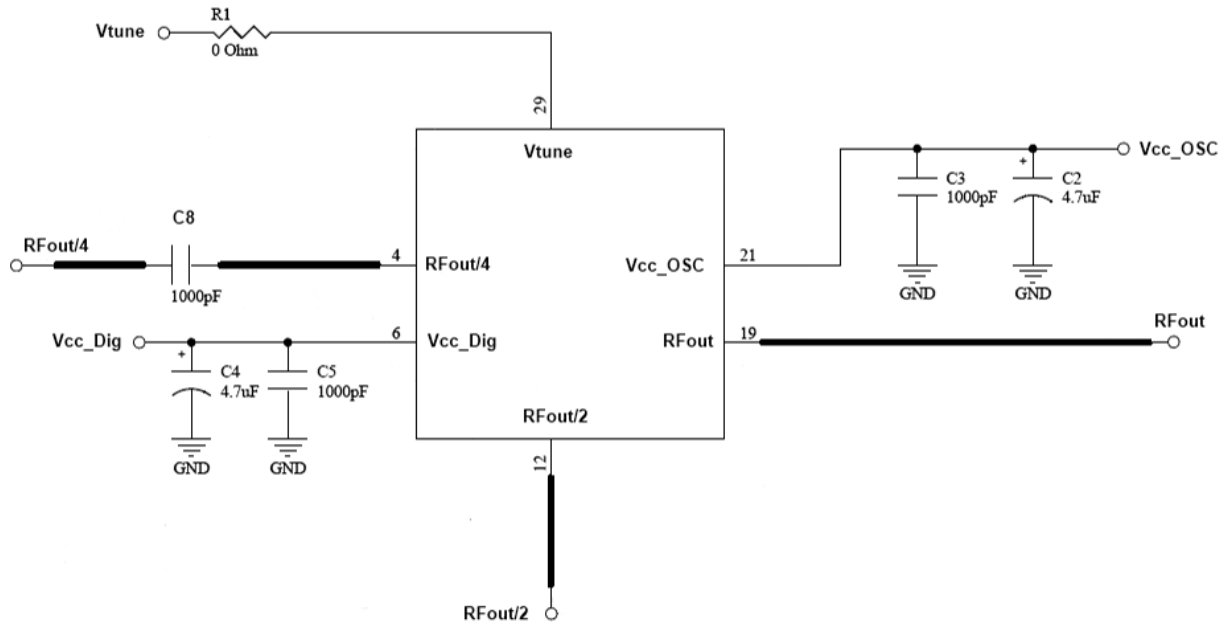

Bias Conditions	Output
$V_{CC_OSC} = 5V$	$F_{OUT} = 8.3GHz$
$V_{CC_DIG} = 5V$	$F_{OUT/2} = 4.15GHz$
$V_{TUNE} = 5V$	$F_{OUT/4} = 2.075GHz$

Evaluation Board Layout

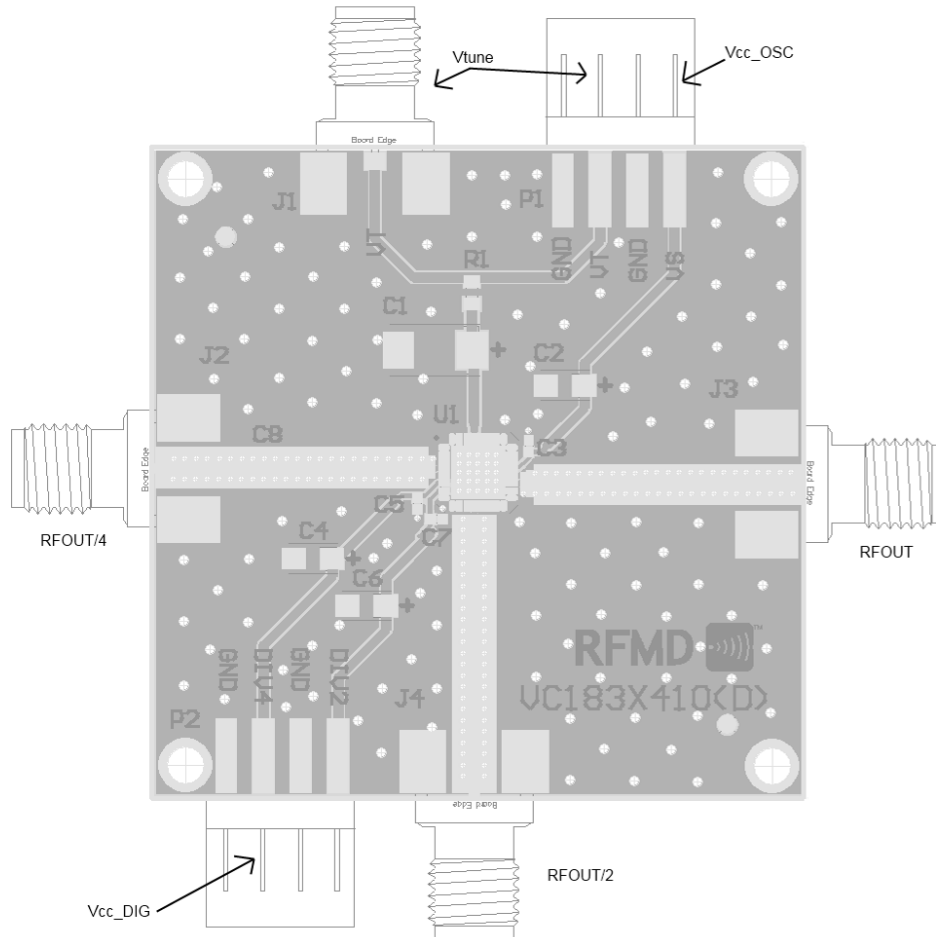

List of Materials for Evaluation Board

Item	Description
U1	RFVC1832 VCO
C3, C5, C7, C8	1000 pF Capacitor, 0402 Package
C2, C4, C6	4.7µF Tantalum Capacitor
C1	68µF Tantalum Capacitor
R1	0Ω Resistor, 0603 Package
P1, P2	4-PIN DC connector
J1, J2, J3, J4	PCB mount SMA connector
PCB	VC183x410(D)